

DETAILS

Sirius-S50 HOME KIT

SIRIUS 
SATELLITE RADIO

Congratulations on the purchase of your new Sirius S50 Home Kit

The Home Kit will allow you to use your Sirius S50 in your home or office to listen to live broadcasts and saved content, and capture and store both scheduled and unscheduled SIRIUS programming. The Home Kit is designed to easily integrate with your home entertainment system and PC computer.

The My Sirius Studio software included with the Home Kit will allow you to supplement the SIRIUS broadcast content with your own MP3/WMA library, when connected to a PC through the USB connection on the dock. My Sirius Studio also allows for channel and image updates automatically when connected to the SIRIUS website.



© 2005 SIRIUS Satellite Radio Inc.

® "SIRIUS", My Sirius Studio, S Series and related marks, the SIRIUS dog logo, channel names and logos are trademarks of SIRIUS Satellite Radio Inc. All Rights Reserved.

Table of Contents

TABLE OF CONTENTS	2
WARNING AND SAFETY INFORMATION	3
FCC Warning.3
FCC Compliance3
Canadian Compliance4
General Precautions4
PACKAGE CONTENTS	5
CONTROLS.	6
Home Dock Reference Guide6
GETTING STARTED	9
Installing the Home Kit9
OPERATION	14
Synchronizing the Sirius S50 to your Computer	14
Accessing the Setup Menu	14
Saving Songs or Shows with a Scheduled Recording.	15
TROUBLESHOOTING	16
SPECIFICATIONS	18
WARRANTY	19

Warning and Safety Information

FCC Warning

This equipment may generate or use radio frequency energy. Changes or modifications to this equipment may cause harmful interference unless the modifications are expressly approved in this owners guide. The user could lose the authority to operate this equipment if an unauthorized change or modification is made.

FCC Compliance

This equipment has been tested and found to comply with Part 15 of the FCC Rules. These rules are designed to provide reasonable protection against harmful interference. This equipment may cause harmful interference to radio communications if it is not installed and used in accordance with these instructions. However, there is no guarantee that interference will not occur in a particular installation. If this equipment does cause harmful interference to radio reception, which can be determined by turning the equipment off and on, the user is encouraged to try to correct the interference by one of more of the following measures:

- Reorient or relocate the receiving antenna.
- Increase the separation between the other equipment and the Receiver.
- Connect the other equipment to a different circuit from that to which the Receiver is connected.
- Consult the dealer or an experienced radio technician for help.

Canadian Compliance

This Class B digital apparatus complies with Canadian ICES-003.

Cet appareil numérique de la classe B est conforme à la norme NMB-003 du Canada.

General Precautions

Safety Precautions

Be sure to observe the following warnings. Failure to follow these safety instructions and warnings may result in a serious accident.

- Be sure the home dock is installed as described in the installation instructions in this guide.
- Failure to follow these safety instructions and warnings may result in a serious accident.
- To avoid short circuits, do not open the unit, and never put or leave any metallic objects (coins, tools, etc.) inside the unit.
- If the unit emits smoke or unusual odors, turn the power off immediately, and disconnect the unit from any power source.
- Do not drop the unit or subject it to strong shocks.
- If the unit doesn't seem to be working properly, turn the unit off, remove the battery from the media player, wait 10 seconds, replace the battery and then turn it on again.

Package Contents

The following items are included with your purchase of the Sirius S50 Home Kit:

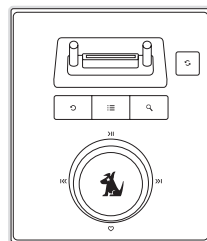

Home Dock



Windowsill
Antenna



USB Cable

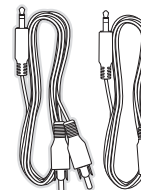

Audio Cables (2)

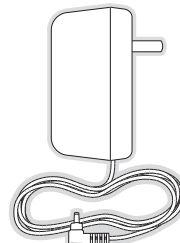

AC Adapter



PC Software CD

Controls

Home Dock Reference Guide

Figure 1 identifies the buttons of the home dock.

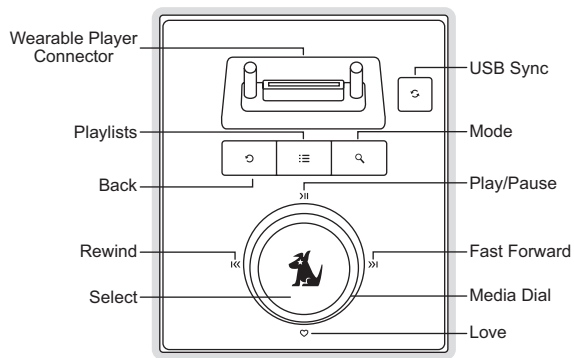











Figure 1

Home Dock Button Descriptions			
Button	Action	Live Environment Description	Playback Environment Description
 Play/Pause	Press	Pauses a live broadcast or resumes playing a broadcast	Plays or pauses the current song or show
	Hold	If paused, returns to live broadcast If in a channel list, plays the highlighted channel	No Action
 Rewind	Press	Rewinds a broadcast to previous song or show	Rewinds to the previous song or show
	Hold	Rewinds through a broadcast	Rewinds through song or show
 Fast-Forward	Press	Fast-Forwards the replay buffer to the next song or show	Fast-Forwards to the next song or show
	Hold	Fast-Forwards through the replay buffer	Fast-Forwards through song or show
 Love	Press	Saves song or show Cancels currently active recording	If listening to My Sirius Channels, saves the content
	Hold		If listening to My Sirius Songs or My Sirius Shows, displays prompt to delete the song or show
 Media Dial	Turn	If listening to live broadcast, tunes next channel If in a list, menu, or prompt, scrolls to next or previous item	If listening to playlist, no action If in a list, menu, or prompt, scrolls to next or previous item
 Select	Press	Selects highlighted items in lists, menus, or prompts	
	Hold	Allows you to Add/Move/Remove a preset	No Action

Home Dock Button Descriptions <i>Continued</i>			
Button	Action	Live Environment Description	Playback Environment Description
 Playlists	Press	Allows you to browse the playlists	Goes to the most recent playlist menu screen and highlights the currently selected song or show If browsing playlists, moves up one level in the playlist menu structure
	Hold	No Action	No Action
 Back	Press	If listening, returns to previous channel or playlist If in a list at the top level, exits and returns back to previous content If in a list not at the top level, moves up one level in the list structure	
	Hold	Jumps to programmed traffic/weather or other channel If a jump is pending, cancels jump If in a list or in Setup, exits the list or Setup	
 Mode	Press	First push allows you to browse live channels according to the current tuning mode Second push cycles browse mode between Channel, Genre, and Presets	
	Hold	Cycles between channel name/artist/title when in browse mode	No Action
 USB Sync	Press	Initiates a USB connection between a PC computer and the home dock	

Getting Started

Installing the Home Kit

If you will be connecting the Home Kit to your PC computer, locate the dock in the vicinity of the computer so that the USB cable can be connected between the dock and the computer. The dock should also be located where the cable from the windowsill antenna can reach the dock.

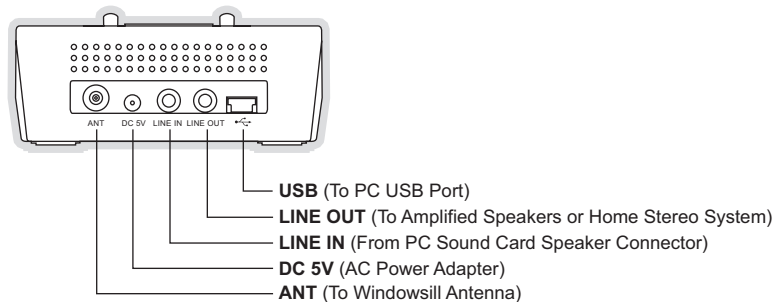

Figure 2

Connecting the AC Power Adapter

Plug the AC power adapter into a working wall outlet, and connect the power cord of the adapter to the **DC 5v** connection on the rear of the home dock. (Figure 2)

Installing the Windowsill Antenna

Before installing the windowsill antenna, read this entire section.

To ensure strong reception of the SIRIUS signal in your home, it is important that the window-sill antenna be oriented correctly. Note the following antenna placement considerations:

BEST reception can be achieved by placing the antenna outside on the roof. The antenna is waterproof. This position will afford the best view of the sky for best reception. When placed in this location, an antenna extension cable may be required.

BETTER reception can be achieved by placing the antenna outside a window, or by mounting it to the side of the house. In either case, try to achieve the best possible clear view of the sky.

GOOD reception can be achieved by placing your antenna in a window. Try to achieve a clear unobstructed view of the sky. If your location is in major metropolitan area, the antenna may be located inside the home because terrestrial transmitters are used to boost signal strength.

From the map shown in Figure 3, determine your location and aim the portion of the antenna with the logo toward the location indicated by the **X** on the map.



Figure 3

Key:

- Area 1: Aim the antenna East, Northeast, or Southeast
- Area 2: Aim the antenna North or Northeast
- Area 3: Aim the antenna North or Northwest
- Area 4: Aim the antenna West, Northwest or Southwest
- Area 5: Aim the antenna Straight Up at the sky

Route the antenna cable to the dock. Be sure you avoid any obstructions that could crimp, kink, or twist the cable. Use protective grommets wherever rough openings are encountered. If the antenna is installed outdoors, route the cable from the antenna location to the interior of the home, working the cable through the basement, under a window sill, etc., and make adjustments to take up cable slack as necessary.

Connect the antenna cable to the **ANT** connection on the rear of the dock. (Figure 2)

Testing and Optimizing the Antenna Signal Strength

The stronger the SIRIUS signal strength, the less likely it is that you will experience an interruption of the audio when listening to a broadcast. To assist you in adjusting the antenna aiming for optimal reception, the Sirius S50 can display a screen showing the strength of the SIRIUS signal being received.

To access the antenna aiming menu, place the media player in the dock without connecting the USB cable. Press the Setup button on the media player and select the *Antenna Aiming* menu option from the *Device Settings* menu. (Figure 4) The SATELLITE portion of the *Antenna Aiming* display screen shows the strength of the signal being received from the satellite, while the TERRESTRIAL portion of the display screen shows the strength of the signal being received from terrestrial based transmitters, if available. Make small adjustments to the aiming of the windowsill antenna until you achieve the strongest possible signal.

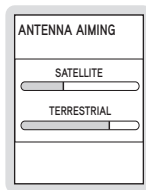

Figure 4

Connecting the Home Dock to Your Computer

You can integrate the home dock with your computer's sound system so that you can utilize the speakers connected to your computer for listening to both the computer and the Sirius S50. When connected in this way, you will be able to listen to Sirius S50 and use the computer at the same time. For example, when using the My Sirius Studio software, you will be able to review the songs recorded in your S50 or in your playlists, or listen to the streaming content available via the SIRIUS internet streaming service through your computer's speakers. Or, when listening to the Sirius S50 while using your computer, you will also be able to hear the various computer sounds.

To connect your computer and the home dock to your computer's speakers, connect the

audio cables as follows:

1. Make a note of the connector on your computer to which your speakers are connected. This is typically a green connector, and may be marked "Speakers" or have a speaker icon. Disconnect the wire plugged into that connector and plug that wire into the **LINE OUT** connection on the rear of the dock. (Figure 2)
2. Connect the provided audio cable which has the 1/8" (3.5mm) connectors on both ends into the connector on the computer which had been connected to the speakers.
3. Connect the other end of this cable to the **LINE IN** connection on the rear of the dock. (Figure 2)

If you will be using your PC computer with the dock, connect the provided USB cable to the **USB** connection on the rear of the dock. (Figure 2) Connect the other end of the USB cable to an available USB port on your computer.

Connecting the Home Dock to Your Stereo System

If you will not be connecting the home dock to your computer's speakers, you may connect the dock to amplified speakers or your home stereo system. Plug the provided audio cable with the RCA-type connectors on one end to your speakers or home stereo system audio input connection, and connect the other end of the cable to the **LINE OUT** connection on the rear of the dock. (Figure 2)

Note that if you are connecting the home dock directly to speakers, you will have to use amplified speakers.

Operation

Synchronizing the Sirius S50 to your Computer

When the Sirius S50 is actively connected to your computer via the USB connection, you will not be able to listen to live broadcasts. Instead, the My Sirius Studio software is used to control the Sirius S50 for viewing content which you have recorded, managing and transferring songs and playlists, or streaming SIRIUS music from the web.

To connect the Sirius S50 to your PC computer, place the media player in the home dock and press the  USB Sync button to initiate the USB connection. This will cause the computer to recognize the Sirius S50. While the computer is connecting, the Sirius S50 will display the **Connecting. Please Wait.** message. When the Sirius S50 is connected to the computer the **DO NOT DISCONNECT** message is displayed, and no buttons on the media player or the home dock will be functional.

To disconnect from the computer, **always** use the *Eject* function of the software to terminate the USB connection before removing the media player from the dock. Failure to do so may result in the corruption of the files in the Sirius S50. Refer to the software manual included on the software CD for more information about using the software, or the manual may be downloaded from the SIRIUS website at <http://www.sirius.com>.

Accessing the Setup Menu

To access the *Setup* menu when the media player is in the home dock, press the  Setup button on the media player.

Saving Shows with a Scheduled Recording

The home dock is able to save shows using the scheduled recording feature, and recordings can occur even if the unit is turned off. The dock will wake up and perform the recording at the scheduled time, provided that the media player is in the dock, the dock is connected to the AC power, and the antenna is receiving a good signal. Upon waking up at one minute prior to the start time of the recording, you will have the option to cancel the recording. If you do not cancel the recording, the scheduled recording will occur and the dock will turn itself off upon completion. Scheduled recordings are limited to a maximum of 20, with a maximum of 2 hours per each recording session.

For more information about scheduled recordings, refer to the manual which accompanied the Sirius S50.

Troubleshooting

Symptom	Solution
Sirius S50 does not power on	Check the battery to be sure it is installed correctly. Charge the battery. Check that the media player is properly seated in the dock. Check the AC power adapter to be sure it's plugged into a working AC outlet, and connected to the home dock.
Sirius S50 displays <i>No Antenna</i>	The windowsill antenna is not connected to the home dock. Check the antenna connection to the dock.
Sirius S50 displays: <i>No Signal</i>	No satellite signal is being received. Check for obstacles over or around the satellite antenna. Check that the media player is properly seated in the dock. Change the antenna location to eliminate nearby obstacles (roof overhangs, trees, buildings, etc.)
Audio from broadcasts starts and stops	The windowsill antenna is not aimed for optimal reception. Refer to the section <i>Installing the Windowsill Antenna</i> and follow the instructions for aiming the antenna.
No sound	The home dock is not connected, or is incorrectly connected, to the amplified speakers or home stereo system. Refer to the section <i>Connecting the Audio Cables</i> and follow the instructions for connecting the home dock to amplified speakers or your home stereo system.
Cannot establish a USB connection with the computer	Check that the USB cable is connected to a working USB port on your computer. Disconnect the USB cable for one minute, then reconnect and press the USB Sync button.

Troubleshooting <i>Continued</i>	
Symptom	Solution
The Sirius S50 will not start up	The operating system files on the Sirius S50 have been deleted. Connect the Sirius S50 to your PC using the USB cable, and use the SIRIUS software to download new operating system files. Follow the software instructions included on the CD.
The Sirius S50 does not respond to the Media Dial or the buttons	Remove the media player from the dock, remove the battery from the media player, wait 10 seconds, replace the battery and turn it back on.

Specifications

Satellite Frequencies	2322.293/2330.207 MHz
Terrestrial Frequencies	2326.250 MHz
Power Requirements5 Volts DC, 1.5A, Center Positive
Operation Temperature	-5° to +40° C (23° to 104° F)
Audio Output	18mW Left + 18mW Right @ 16 ohms
Signal-to-noise (S/N)90dB (MP3)
Dock Dimensions (Height x Width x Depth)	3.27" x 3.9" x 1.34" (8.3cm x 9.9cm x 3.4cm)
Antenna Type	Windowsill
Antenna Cable Length	21' (single micro-cable)
Antenna Connector Type	SMB
Audio Interface (Line In/Line Out)	1/8" / 3.5mm Stereo Jack

Warranty

12 Month Warranty

SIRIUS Satellite Radio Inc. (the "Company") warrants to the original retail purchaser of this product that should this product or any part thereof, under normal use and conditions, be proven defective in material or workmanship within 12 months from the date of original purchase, such defect(s) will be repaired or replaced with new or reconditioned product (at the Company's option) without charge for parts and repair labor. To obtain repair or replacement within the terms of this Warranty, the product is to be delivered with proof of warranty coverage (e.g. dated bill of sale), specification of defect(s), transportation prepaid, to the location shown below under WARRANTY RETURN.

This Warranty does not extend to the elimination of externally generated static or noise, to correction of antenna problems, to costs incurred for installation, removal or reinstallation of the product, or to damage to tapes, compact discs, speakers, accessories, or vehicle electrical systems.

This Warranty does not apply to any product or part thereof which, in the opinion of the Company, has suffered or been damaged through alteration, improper installation, mishandling, misuse, neglect, accident, or by removal or defacement of the factory serial number/bar code label(s). THE EXTENT OF THE COMPANY'S LIABILITY UNDER THIS WARRANTY IS LIMITED TO THE REPAIR OR REPLACEMENT PROVIDED ABOVE AND, IN NO EVENT, SHALL THE COMPANY'S LIABILITY EXCEED THE PURCHASE PRICE PAID BY PURCHASER FOR THE PRODUCT.

This Warranty is in lieu of all other express warranties or liabilities. ANY IMPLIED WARRANTIES, INCLUDING ANY IMPLIED WARRANTY OF MERCHANTABILITY, SHALL BE LIMITED TO THE DURATION OF THIS WRITTEN WARRANTY. ANY ACTION FOR BREACH OF ANY WARRANTY HERE-UNDER INCLUDING ANY IMPLIED WARRANTY OF MERCHANTABILITY MUST BE BROUGHT WITHIN A PERIOD OF 48 MONTHS FROM DATE OF ORIGINAL PURCHASE. IN NO CASE SHALL THE COMPANY BE LIABLE FOR ANY CONSEQUENTIAL OR INCIDENTAL DAMAGES FOR BREACH OF THIS OR ANY OTHER WARRANTY, EXPRESS OR IMPLIED, WHATSOEVER. No person or representative is authorized to assume for the Company any liability other than expressed herein in connection with the sale of this product. Some states do not allow limitations on how long an implied warranty lasts or the exclusion or limitation of incidental or consequential damage so the above limitations or exclusions may not apply to you. This Warranty gives you specific legal rights and you may also have other rights which vary from state to state.

WARRANTY RETURN: To obtain repair or replacement within the terms of this Warranty, please return product to an authorized retailer or call Customer Service at 1-800-869-5590; proof of purchase and description of defect are required. Products to be returned to an approved warranty station must be shipped freight prepaid.



SIRIUS Customer Service: 1-800-869-5590
Sirius S50 Product Support: 1-800-869-5364
customercare@sirius-radio.com

SIRIUS Satellite Radio Inc.
1221 Avenue of the Americas
New York, NY 10020
1-888-539-7474
<http://www.sirius.com>



USER MANUAL

Sirius-S50 HOME KIT
