

DETAILS

Sirius-S50 EXECUTIVE SYSTEM

SIRIUS 
SATELLITE RADIO

Congratulations on the purchase of your new Sirius S50 Executive System

The Executive System will allow you to use your Sirius S50 in your home or office to listen to live broadcast and stored content. Its two-way speaker design ensures accurate reproduction of any music or other content you wish to listen to. While docked in the Executive System, the Sirius S50 can capture both scheduled and unscheduled SIRIUS programming.



© 2006 SIRIUS Satellite Radio Inc.

® "SIRIUS", My Sirius Studio, S Series and related marks, the SIRIUS dog logo, channel names and logos are trademarks of SIRIUS Satellite Radio Inc. All Rights Reserved.

Table of Contents

TABLE OF CONTENTS	2
WARNING AND SAFETY INFORMATION	3
FCC Warning.	3
FCC Compliance	3
Canadian Compliance	4
General Precautions	4
PACKAGE CONTENTS	5
CONTROLS.	6
GETTING STARTED	10
Installing the Executive System	10
Connecting the AC Power Adapter	11
Installing the Windowsill Antenna.	12
OPERATION	15
TROUBLESHOOTING	16
SPECIFICATIONS	17
WARRANTY	18

Warning and Safety Information

FCC Warning

This equipment may generate or use radio frequency energy. Changes or modifications to this equipment may cause harmful interference unless the modifications are expressly approved in this owners guide. The user could lose the authority to operate this equipment if an unauthorized change or modification is made.

FCC Compliance

This equipment has been tested and found to comply with Part 15 of the FCC Rules. These rules are designed to provide reasonable protection against harmful interference. This equipment may cause harmful interference to radio communications if it is not installed and used in accordance with these instructions. However, there is no guarantee that interference will not occur in a particular installation. If this equipment does cause harmful interference to radio reception, which can be determined by turning the equipment off and on, the user is encouraged to try to correct the interference by one of more of the following measures:

- Reorient or relocate the receiving antenna.
- Increase the separation between the other equipment and the Receiver.
- Connect the other equipment to a different circuit from that to which the Receiver is connected.
- Consult the dealer or an experienced radio technician for help.

Canadian Compliance

This Class B digital apparatus complies with Canadian ICES-003.

Cet appareil numérique de la classe B est conforme à la norme NMB-003 du Canada.

General Precautions

Safety Precautions

Be sure to observe the following warnings. Failure to follow these safety instructions and warnings may result in a serious accident.

- Be sure the Executive System is installed as described in the installation instructions in this guide.
- Failure to follow these safety instructions and warnings may result in a serious accident.
- To avoid short circuits, do not open the unit, and never put or leave any metallic objects (coins, tools, etc.) inside the system.
- If the unit emits smoke or unusual odors, turn the power off immediately, and disconnect the system from any power source.
- Do not drop the system or subject it to strong shocks.
- If the unit doesn't seem to be working properly, turn the unit off, remove the battery from the media player, wait 10 seconds, replace the battery and then turn it on again.

Package Contents

The following items are included with your purchase of the Sirius S50 Executive System:

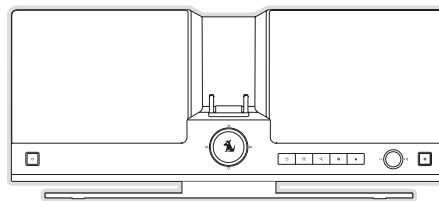

**Executive System with
Desk Mount Bracket**



**Windowsill
Antenna**



Remote Control

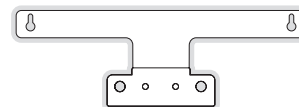

Wall Mount Bracket

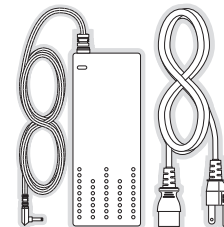

**AC Power Adapter
and Power Cord**

Controls

Figure 1 identify the buttons and connectors of the Executive System.

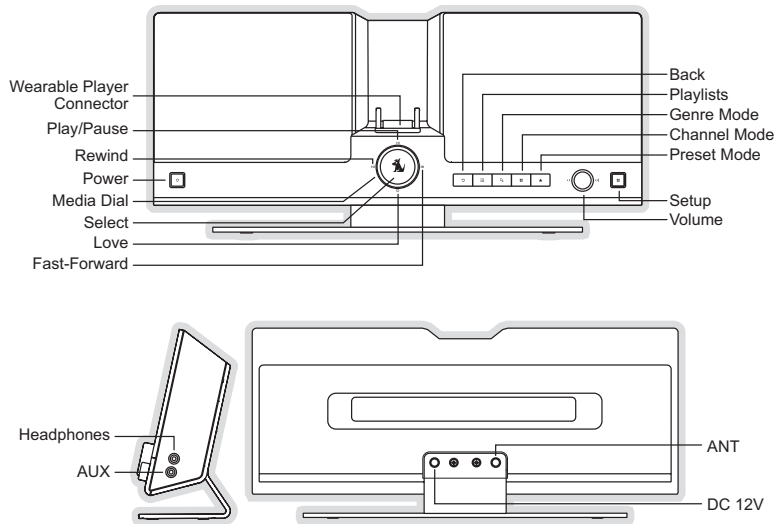















Figure 1

The following tables describe the functions of the buttons, controls, and connectors on the Executive System. Please refer to your Sirius S50 manual for more information about each of these buttons and features.

Executive System Button Descriptions			
Button	Action	Live Environment Description	Playback Environment Description
 Play/Pause	Press	Pauses a live broadcast or resumes playing a broadcast	Plays or pauses the current song or show
	Hold	If paused, returns to live broadcast If in a channel list, plays the highlighted channel	No Action
 Rewind	Press	Rewinds a broadcast to previous song or show	Rewinds to the previous song or show
	Hold	Rewinds through a broadcast	Rewinds through song or show
 Fast-Forward	Press	Fast-Forwards the replay buffer to the next song or show	Fast-Forwards to the next song or show
	Hold	Fast-Forwards through the replay buffer	Fast-Forwards through song or show
 Love	Press	Saves song or show Cancels currently active recording	If listening to My Sirius Channels, saves the content
	Hold		If listening to My Sirius Songs or My Sirius Shows, displays prompt to delete the song or show

Executive System Button Descriptions <i>Continued</i>			
Button	Action	Live Environment Description	Playback Environment Description
 Media Dial	Turn	If listening to live broadcast, tunes next channel If in a list, menu, or prompt, scrolls to next or previous item	If listening to playlist, no action If in a list, menu, or prompt, scrolls to next or previous item
 Select	Press	Selects highlighted items in lists, menus, or prompts	
	Hold	Allows you to Add/Move/Remove a preset	No Action
 Playlists	Press	Allows you to browse the playlists	Goes to the most recent playlist menu screen and highlights the currently selected song or show If browsing playlists, moves up one level in the playlist menu structure
	Hold	No Action	No Action
 Back	Press	If listening, returns to previous channel or playlist If in a list at the top level, exits and returns back to previous content If in a list not at the top level, moves up one level in the list structure	
	Hold	Jumps to programmed traffic/weather or other channel If a jump is pending, cancels jump If in a list or in Setup, exits the list or Setup	

Executive System Button Descriptions <i>Continued</i>			
Button	Action	Live Environment Description	Playback Environment Description
 Genre Mode	Press	Displays the list of genres which may be browsed. When a genre is selected, the channels within the genre are displayed	
	Hold	No Action	No Action
 Channel Mode	Press	Displays the list of channels which may be browsed and selected	
	Hold	No Action	No Action
 Preset Mode	Press	Displays the list of presets which may be browsed and selected	
	Hold	No Action	No Action
 Setup	Press	Displays the <i>Setup</i> menu	
	Hold	If in the <i>Setup</i> menus, moves up one level in the menu structure	
 Volume	Turn	Increases or decreases the audio volume	

Executive System Connector Descriptions	
Connector	Description
ANT	Connection for the Windowsill Antenna.
DC 12V	Connection for the AC Adapter.
AUX	Optional audio input for a CD player, MP3 player or other audio source. An audio cable (not supplied) is required to utilize this connection. The Executive System can detect when there is an auxiliary input and it will switch automatically. You must remove the input cable to listen to the Sirius S50.
Headphones	Connection for headphones.

Getting Started

Installing the Executive System

The Executive System should be located where the cable from the windowsill antenna can reach it when the windowsill antenna is installed in a suitable location. It may be located on a table or desk using the desk stand bracket already attached, or mounted to a wall using the wall bracket. If you will be wall mounting the Executive System, remove the screws from the desk mount bracket as shown in Figure 2 and attach the wall mount bracket as shown in Figure 3.

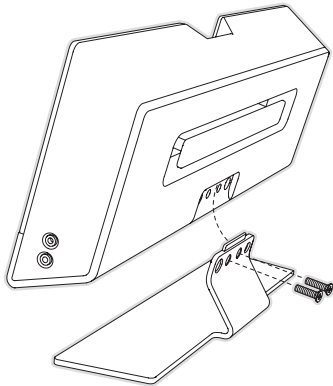

Figure 2

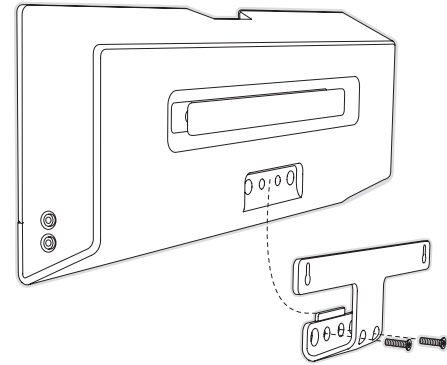

Figure 3

Connecting the AC Power Adapter

Connect the power cord to the AC power adapter and plug the power cord into a working wall outlet. Connect the DC power plug from the adapter to the **DC 12V** connection at the rear of the Executive System. (Refer to Figure 1 on page 6 for the location of this connection.)

Installing the Windowsill Antenna

Before installing the windowsill antenna, read this entire section.

To ensure strong reception of the SIRIUS signal in your home or office, it is important that the windowsill antenna be oriented correctly. Note the following antenna placement considerations:

BEST reception can be achieved by placing the antenna outside on the roof. The antenna is waterproof. This position will afford the best view of the sky for best reception. When placed in this location, an antenna extension cable may be required.

BETTER reception can be achieved by placing the antenna outside a window, or by mounting it to the side of the house. In either case, try to achieve the best possible clear view of the sky.

GOOD reception can be achieved by placing your antenna in a window. Try to achieve a clear unobstructed view of the sky. If your location is in major metropolitan area, the antenna may be located inside the home because terrestrial transmitters are used to boost signal strength.

From the map shown in Figure 4, determine your location and aim the portion of the antenna with the logo toward the location indicated by the **X** on the map.

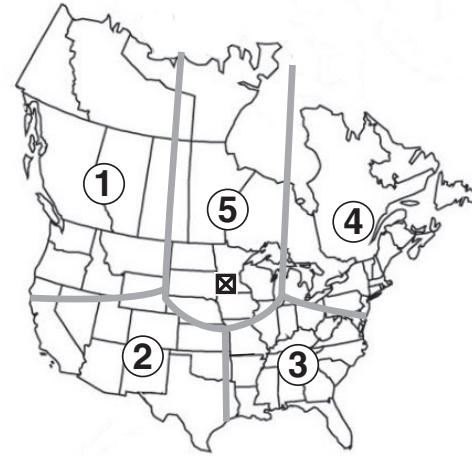

Figure 4

Key:

- Area 1: Aim the antenna East, Northeast, or Southeast
- Area 2: Aim the antenna North or Northeast
- Area 3: Aim the antenna North or Northwest
- Area 4: Aim the antenna West, Northwest or Southwest
- Area 5: Aim the antenna Straight Up at the sky

Route the antenna cable to the system. Be sure you avoid any obstructions that could crimp, kink, or twist the cable. Use protective grommets wherever rough openings are encountered. If the antenna is installed outdoors, route the cable from the antenna location to the interior of the home, working the cable through the basement, under a window sill, etc., and make adjustments to take up cable slack as necessary.

Connect the antenna cable to the **ANT** connection on the rear of the system. (Figure 1)

Testing and Optimizing the Antenna Signal Strength

The stronger the SIRIUS signal strength, the less likely it is that you will experience an interruption of the audio when listening to a broadcast. To assist you in adjusting the antenna aiming for optimal reception, the Sirius S50 can display a screen showing the strength of the SIRIUS signal being received.

To access the antenna aiming menu, place the media player in the system. Press the Setup button on Executive System and select the *Antenna Aiming* menu option from the *Device Settings* menu. (Figure 5) The SATELLITE portion of the *Antenna Aiming* display screen shows the strength of the signal being received from the satellite, while the TERRESTRIAL portion of the display screen shows the strength of the signal being received from terrestrial based transmitters, if available. Make small adjustments to the aiming of the windowsill antenna until you achieve the strongest possible signal.

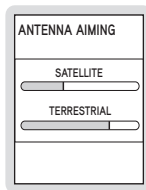

Figure 5

Operation

Please refer to the user manual which accompanied your S50 for detailed instructions for using your S50. The various buttons on the Executive System function the same as the corresponding buttons on the S50.

If you want to use headphones to listen to your Executive System, plug the headphones into the headphone jack on the right side of the unit, as shown in Figure 1 on Page 6.

If you want to connect an audio device such as an MP3 player or CD player to your Executive system, connect the audio output from audio device to the **AUX** connection on the right side of the unit, as shown in Figure 1 on Page 6.

Troubleshooting

Symptom	Solution
Sirius S50 does not power on	Check the battery to be sure it is installed correctly. Charge the battery. Check that the media player is properly seated in the dock. Check the AC power adapter to be sure it's plugged into a working AC outlet, and connected to the system.
Sirius S50 displays <i>No Antenna</i>	The windowsill antenna is not connected to the system. Check the antenna connection to the system. Check that the media player is properly seated in the dock.
Sirius S50 displays: <i>No Signal</i>	No satellite signal is being received. Check that the media player is properly seated in the dock. Check for obstacles over or around the satellite antenna. Change the location to eliminate nearby obstacles (roof overhangs, trees, buildings, etc.)
Audio from broadcasts starts and stops	The windowsill antenna is not aimed for optimal reception. Refer to the section <i>Installing the Windowsill Antenna</i> and follow the instructions for aiming the antenna.
The Sirius S50 will not start up	The operating system files on the Sirius S50 have been deleted. Connect the Sirius S50 to your PC using the USB cable, and use the SIRIUS software to download new operating system files. Follow the software instructions included on the CD.
The Sirius S50 does not respond to the Media Dial or the buttons	Remove the media player from the dock, remove the battery from the media player, wait 10 seconds, replace the battery and turn it back on.

Specifications

Satellite Frequencies	2322.293/2330.207 MHz
Terrestrial Frequencies	2326.250 MHz
Power Requirements	12 Volts DC, 2.0A, Center Positive
Operation Temperature	-5° to +40° C (23° to 104° F)
Signal-to-noise (S/N)90dB (MP3)
Executive System Dimensions (Height x Width x Depth)	15.88cm x 40.64cm x 5.72cm (6.25" x 16" x 2.25")
Antenna Type	Windowsill
Antenna Cable Length	21' (single micro-cable)
Antenna Connector Type	SMB
Audio Interface (AUX)	1/8" / 3.5mm Stereo Jack

12 Month Warranty

SIRIUS Satellite Radio Inc. (the "Company") warrants to the original retail purchaser of this product that should this product or any part thereof, under normal use and conditions, be proven defective in material or workmanship within 12 months from the date of original purchase, such defect(s) will be repaired or replaced with new or reconditioned product (at the Company's option) without charge for parts and repair labor. To obtain repair or replacement within the terms of this Warranty, the product is to be delivered with proof of warranty coverage (e.g. dated bill of sale), specification of defect(s), transportation prepaid, to the location shown below under WARRANTY RETURN.

This Warranty does not extend to the elimination of externally generated static or noise, to correction of antenna problems, to costs incurred for installation, removal or reinstallation of the product, or to damage to tapes, compact discs, speakers, accessories, or vehicle electrical systems.

This Warranty does not apply to any product or part thereof which, in the opinion of the Company, has suffered or been damaged through alteration, improper installation, mishandling, misuse, neglect, accident, or by removal or defacement of the factory serial number/bar code label(s). THE EXTENT OF THE COMPANY'S LIABILITY UNDER THIS WARRANTY IS LIMITED TO THE REPAIR OR REPLACEMENT PROVIDED ABOVE AND, IN NO EVENT, SHALL THE COMPANY'S LIABILITY EXCEED THE PURCHASE PRICE PAID BY PURCHASER FOR THE PRODUCT.

This Warranty is in lieu of all other express warranties or liabilities. ANY IMPLIED WARRANTIES, INCLUDING ANY IMPLIED WARRANTY OF MERCHANTABILITY, SHALL BE LIMITED TO THE DURATION OF THIS WRITTEN WARRANTY. ANY ACTION FOR BREACH OF ANY WARRANTY HERE- UNDER INCLUDING ANY IMPLIED WARRANTY OF MERCHANTABILITY MUST BE BROUGHT WITHIN A PERIOD OF 48 MONTHS FROM DATE OF ORIGINAL PURCHASE. IN NO CASE SHALL THE COMPANY BE LIABLE FOR ANY CONSEQUENTIAL OR INCIDENTAL DAMAGES FOR BREACH OF THIS OR ANY OTHER WARRANTY, EXPRESS OR IMPLIED, WHATSOEVER. No person or representative is authorized to assume for the Company any liability other than expressed herein in connection with the sale of this product. Some states do not allow limitations on how long an implied warranty lasts or the exclusion or limitation of incidental or consequential damage so the above limitations or exclusions may not apply to you. This Warranty gives you specific legal rights and you may also have other rights which vary from state to state.

WARRANTY RETURN: To obtain repair or replacement within the terms of this Warranty, please return product to an authorized retailer or call Customer Service at 1-800-869-5364; proof of purchase and description of defect are required. Products to be returned to an approved warranty station must be shipped freight prepaid.



SIRIUS Customer Service: 1-800-869-5590
Sirius S50 Product Support: 1-800-869-5364
customercare@sirius-radio.com

SIRIUS Satellite Radio Inc.
1221 Avenue of the Americas
New York, NY 10020
1-888-539-7474
<http://www.sirius.com>



USER MANUAL

Sirius-S50 EXECUTIVE SYSTEM
