

PQ40.2

owner's manual

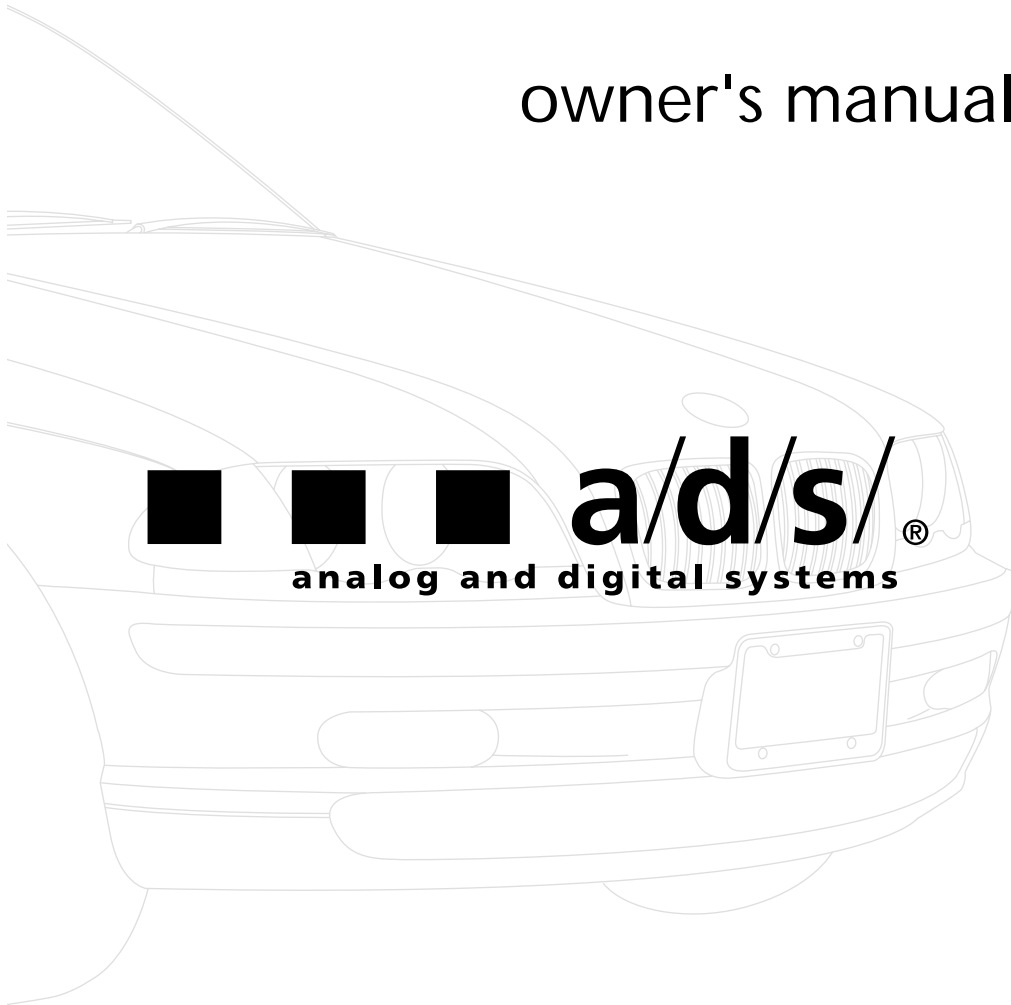

analog and digital systems

table of contents

introduction	1
about this manual.....	2
features of your PowerPlate™.....	2
warning and tips.....	3
mounting locations.....	3
system planning.....	4
system configurations.....	5-9
amplifier and crossover controls	10-11
installation	12
controls and connections.....	12-13
signal sources.....	14
internal signal routing.....	15
multi-cross™ crossover and configurations.....	16
constant bass control.....	17
AC502 operation	17
tuning.....	17-18
troubleshooting	19-20
specifications.....	21
warranty information	22

introduction

Although it may be hard to remember, back in the 1970's, car audio as we now know it didn't really exist. Sure, music lovers could buy a cassette or 8-track tape deck and some 6" x 9" three-way speakers. Advanced stereo buffs might even add a "power-booster" to increase output too as much as 12 watts RMS! But none of this really delivered the power to cut through road noise with sound quality that compared with the best home audio. Not until 1979 that is, when a/d/s/ introduced the revolutionary PowerPlate™ P100 amplifier and 300i 2-way plate loudspeakers. Aesthetically, the P100 introduced the low profile design which has been an a/d/s/ trademark to this day. Technologically, the P100 combined a high efficiency switching power supply with a state-of-the-art, discrete high-current stereo power amplifier. For the first time, a car audio system existed with the musical integrity and dynamic range that made you want to take long drives to nowhere, just to listen to the music. High quality car audio was born, and the original a/d/s/ PowerPlate™ P100 made it happen.

The latest improvements to the PowerPlate™ line-up include increased heatsink area to facilitate higher power output, Constant Bass circuit for subwoofer signal that can be mixed into all channels, and fully balanced high-level inputs compatible with any source. The amplifier you have purchased is an enhancement of the respected P-series multichannel amplifiers. In this version, we have improved upon the already acclaimed sound quality by addressing internal details, and upgrading selected components to incorporate the latest technology which was not available when the P-series was originally designed. Selected low-noise, high-speed Burr-Brown® op amps are used in critical circuits. Class-A biasing is used throughout the voltage-gain and active crossover stages. Numerous modifications and "tweaks" were also performed which improve the power supply dynamics and reduce noise. These changes improve transparency and dynamic linearity, resulting in a smoother and more detailed top-end, tighter bass, more explosive dynamic contrasts, and virtually holographic imaging. Left intact are the P-series unequalled flexibility, high efficiency and superb reliability. These, along with multichannel design, are fundamental in the a/d/s/ approach to systems engineering, which makes achieving true high fidelity reproduction simple and predictable in any installation.

about this manual

To get the most from your a/d/s/ PowerPlate™, we recommend that you have the installation performed by your qualified authorized a/d/s/ dealer. If this unit is installed by your dealer, we will extend the warranty to two years instead of the standard one-year. However, if you feel that you have the necessary skills and prefer to perform the installation yourself, this manual will guide you through the process of installation and set-up. Please read through it completely before beginning the installation so that you may familiarize yourself with the total procedure before you begin. If there is anything that you do not fully understand, please consult with your a/d/s/ dealer before attempting the installation.

keep listening, but be safe!

Sustained listening to loud music over 100dB has been shown to cause permanent hearing damage. Systems using a/d/s/ components are capable of achieving volume levels, which substantially exceed this level. When operating your system for sustained periods at high volume, be sure to use hearing protection to prevent long-term exposure. We want you to be able to enjoy the music for many more years.

features of your PowerPlate™

Transient Perfect™ MOSFET Power Supply - The heart of the P-series, this supply frees the PowerPlate™ from the constraints of common pwm (pulse width modulated) supplies. The advantages are: extremely fast overload recovery time, low output impedance for superior damping, and stability during voltage fluctuations for reliable performance in the harsh automotive environment.

Remote Subwoofer or Constant Bass Level Control Capability - Can be used with accessory control AC502 to provide a dashboard mounted rear channel subwoofer or Constant Bass level control

Digital Crossover Frequency Display - The crossover frequency for each channel pair is displayed on the top of the amplifier for quicker, more precise system tuning

Detachable Plug in Connectors - High current speaker and power connectors simplifies installation.

Multi-cross™ Variable Built-in Crossovers - High-pass, Low-pass and Bandpass functions are built-in, virtually eliminating the need for external crossover networks in even the most elaborate systems.

Constant Bass circuit - Signal from all input channels is summed, low-pass filtered and then made available to all channels.

PowerPlate™ Design - a/d/s/ original low profile, high efficiency heatsink design keeps size minimum and allows mounting where space is limited.

Wide Input Sensitivity Range - Allows connection to virtually any source unit from factory OEM radios through low output preamps.

Simultaneous Stereo and Mono - Each channel pair may be used Stereo, Mono, Bridged or both Stereo and Mono simultaneously. This allows an additional Mono speaker to be used with a stereo pair for center-channel or subwoofer applications from each channel pair.

Same Side Adjustments - The P-series PowerPlate™ makes system adjustment easy by organizing all signal-processing controls on one side of the amplifier. This layout allows convenient system adjustment and facilitates a variety of installation possibilities when access to the controls is desired.

warnings and tips

Always disconnect the battery ground wire before doing any work on your vehicle. Reconnect the cable only after the installation is complete and the wiring has been checked to make sure that there are no problems. If your radio features a code type security system, be sure you know the code before disconnecting the battery!

Your a/d/s/ PowerPlate™ should be installed in 12V negative ground vehicles only. Connection to other types of electrical systems may cause damage to the vehicle or the amplifier. Wear Eye and Ear protection when using power tools.

Before cutting or drilling carefully inspect the area to make sure there are no electrical wiring, fuel lines or brake lines that could be damaged. Sometimes these components may be hidden between double-walled panels, so be very careful.

Do not bypass or modify the fuses, or replace with one of a higher rating. The fuse should not fail under normal operation. Repeated blowing indicates a problem with the amplifier or improper installation. An additional power supply line fuse (not supplied) must be installed on the 12V supply line and located as close as possible to the battery in order to protect the wire in the event of a short circuit.

Make sure the system is turned off when making or breaking any connections. Do not use your PowerPlate™ with speakers which have either terminal connected to the speaker frame or to the vehicle chassis.

mounting locations

Due to its low profile, there are many possible choices of mounting locations. Always mount the PowerPlate™ in a place that protects it from the elements. In addition, mount the PowerPlate™ on a stable, flat mounting surface. Whenever possible, pre-drill the mounting holes. Remember to check behind the panel for hidden dangers in the form of hoses, fuel or brake lines or electrical wiring. Use a marking pen or awl to mark the hole locations and pre-drill using a 1/8" bit.

Passenger compartment mounting

All PowerPlates™ have been designed with a low profile to make under seat mounting possible. Regardless of where you choose to mount your PowerPlate™ be sure to keep a minimum of 1" of clearance around the amplifier for adequate airflow to prevent overheating.

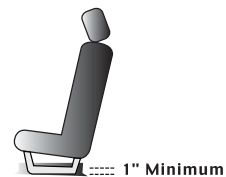

Trunk compartment mounting

The most common mounting location is in the trunk or cargo compartment. For optimum cooling, mount the PowerPlate™ chassis vertically with the fins running vertically, or mount the PowerPlate™ horizontally with the fins pointing upward. Avoid horizontal mounting locations with the fins pointing downward.

Also, locate the PowerPlate™ where it, and connections to it, will not be damaged by cargo or tools, which may shift during vehicle operation.

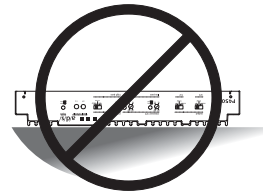

Engine compartment mounting

Don't even think about it! The PowerPlate™ was not designed to endure the harsh chemical and heat environment of the engine compartment. Failure to obey this warning will void your warranty.



system planning

Proper system planning is the best way to maximize your PowerPlate™ performance. By planning your installation carefully you can avoid situations where the performance or the reliability of your system is compromised. Your authorized a/d/s/ dealer has been trained to maximize your system's sonic potential. Your a/d/s/ dealer is a valuable resource in helping you with your system design and installation.

speaker requirements

Each channel of your PowerPlate™ can easily drive 2 speaker loads when used in the stereo mode. When a channel-pair is bridged, the recommended minimum load impedance is 4 for subwoofer use, and 4 for full range operation. Although operation with lower impedances is not likely to cause immediate damage to the internal circuitry, the unit will most likely overheat, causing the thermal protection circuitry to shut down the amplifier. When the chassis cools down, normal operation will resume. Continuing to operate the amplifier under these conditions is not recommended and will reduce its life expectancy.

Most speakers designed for car audio operation are 4 impedance. Connecting two such speakers in parallel will result in a 2 impedance load as seen by the amplifier. Some a/d/s/ subwoofer models feature a dual 4 voice coil design. Connecting these voice coils in parallel will result in a 2 nominal impedance, which is not recommended for use with bridged channels of your PowerPlate™.

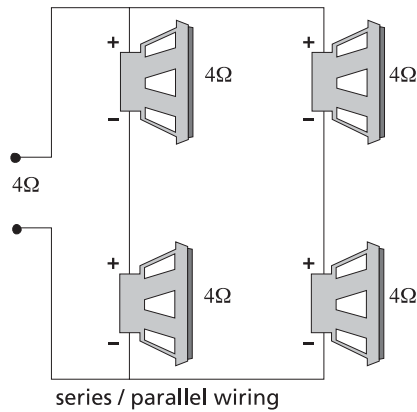
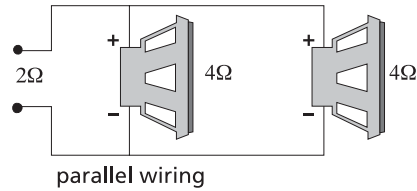
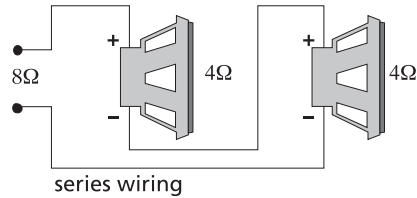

system configurations

All a/d/s/ PowerPlates™ provide extensive features, which make a variety of system configurations possible. It is not feasible to cover all of the possibilities within the few pages of this manual. There are a few system configurations, however, which are extremely popular when used alone or as a "building block" of a larger more elaborate system. Please review systems 1 through 6 described below for suggestions on how to configure the most popular combinations. Larger systems may be built from a combination of the simpler building blocks as shown in systems 7.

- button is disengaged
- control is non-operational
- button is engaged
- control is operational

System 1 - PQ40.2 used in 4-channel mode with front and rear full range speakers.

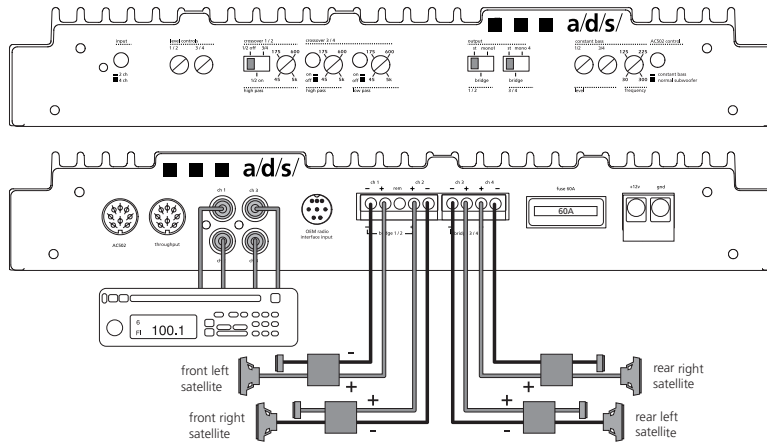

System 2 - PQ40.2 used in 3-channel mode with high-pass main speakers and low-pass subwoofer.

Note: Although shown as 2-channel, the source unit may be either 2 or 4-channel depending on the setting of the 2/4 channel switch.

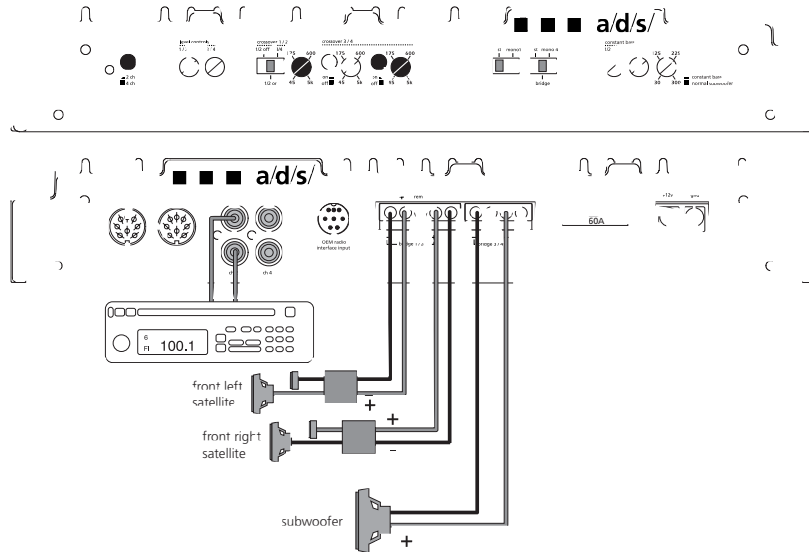

System 3 - PQ40.2 used in 4-channel mode with 2 channels high-pass, 2 channels low-pass or bandpass. Depending on the crossover frequency chosen, this configuration may be used for satellite/subwoofer operation or to bi-amp a midrange/tweeter combination as shown.

Note: Although shown as 2-channel, the source unit may be either 2 or 4-channel depending on the setting of the 2/4 channel switch.

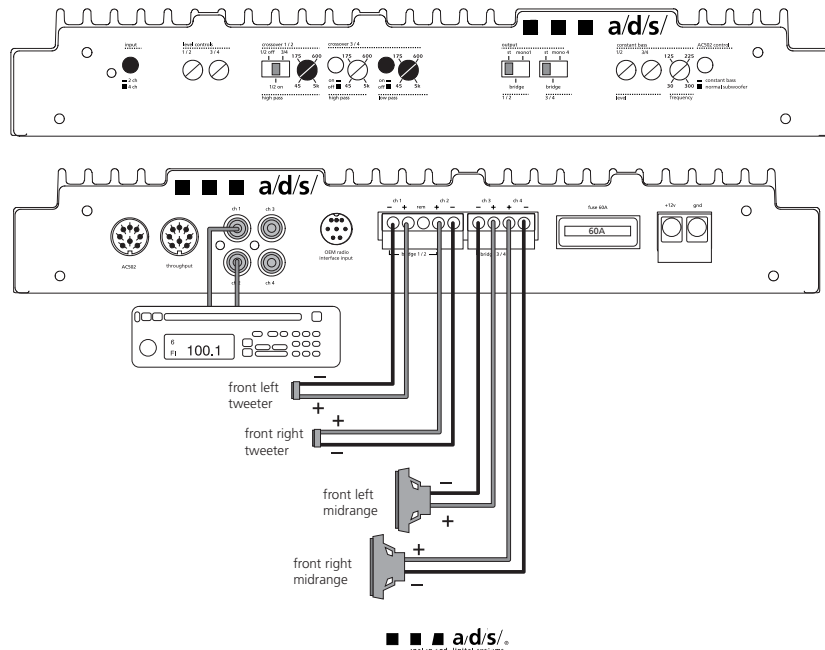

System 4 - PQ40.2 in 2-channel bridged mode. Commonly used for subwoofers but may also be used for full range, midbass or midrange applications depending on crossover mode and frequency setting. Optional: AC502 can be used in this mode.

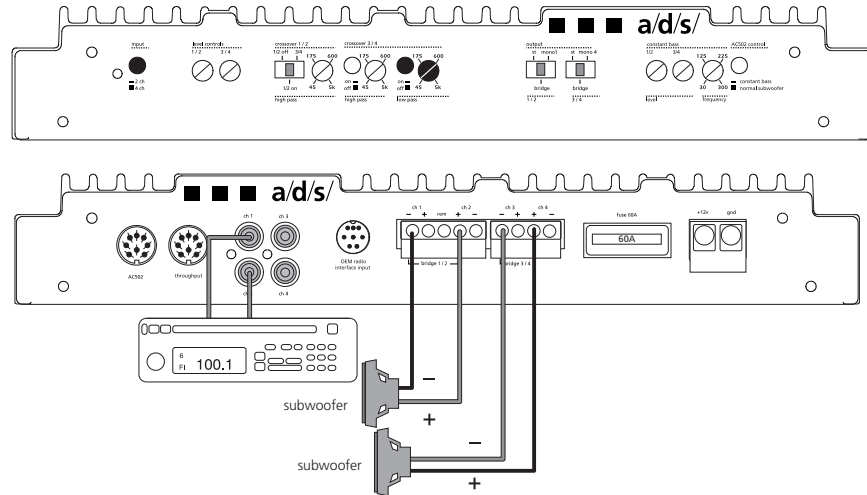

System 5 - PQ40.2 used in front high-pass, rear tri-mode operation. Channels 1 & 2 can be configured for high-pass or full range operation. Rear channel must be configured for full range operation. Important! Choose passive crossover frequencies for the subwoofer and high-pass speakers that do not overlap.

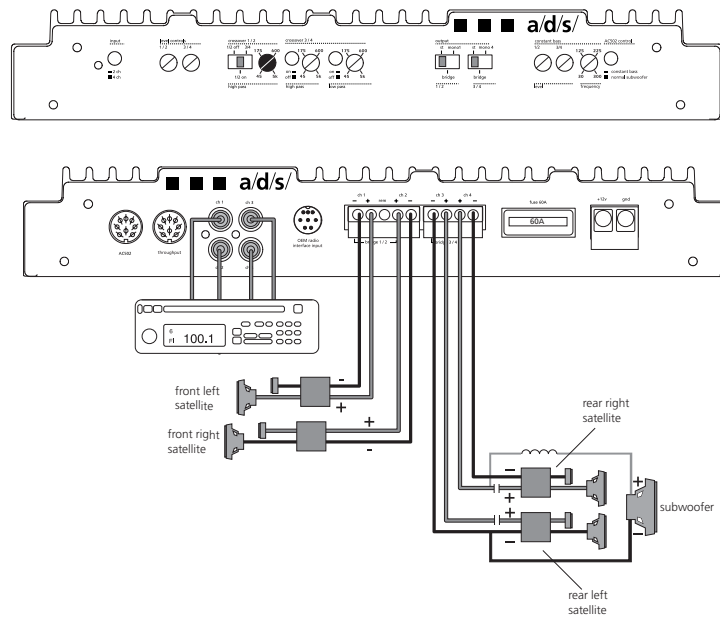

System 7 - Two PQ40.2's, both set up as in system 2. One amp drives front speakers and one subwoofer with the second amp driving rear speakers and one subwoofer.

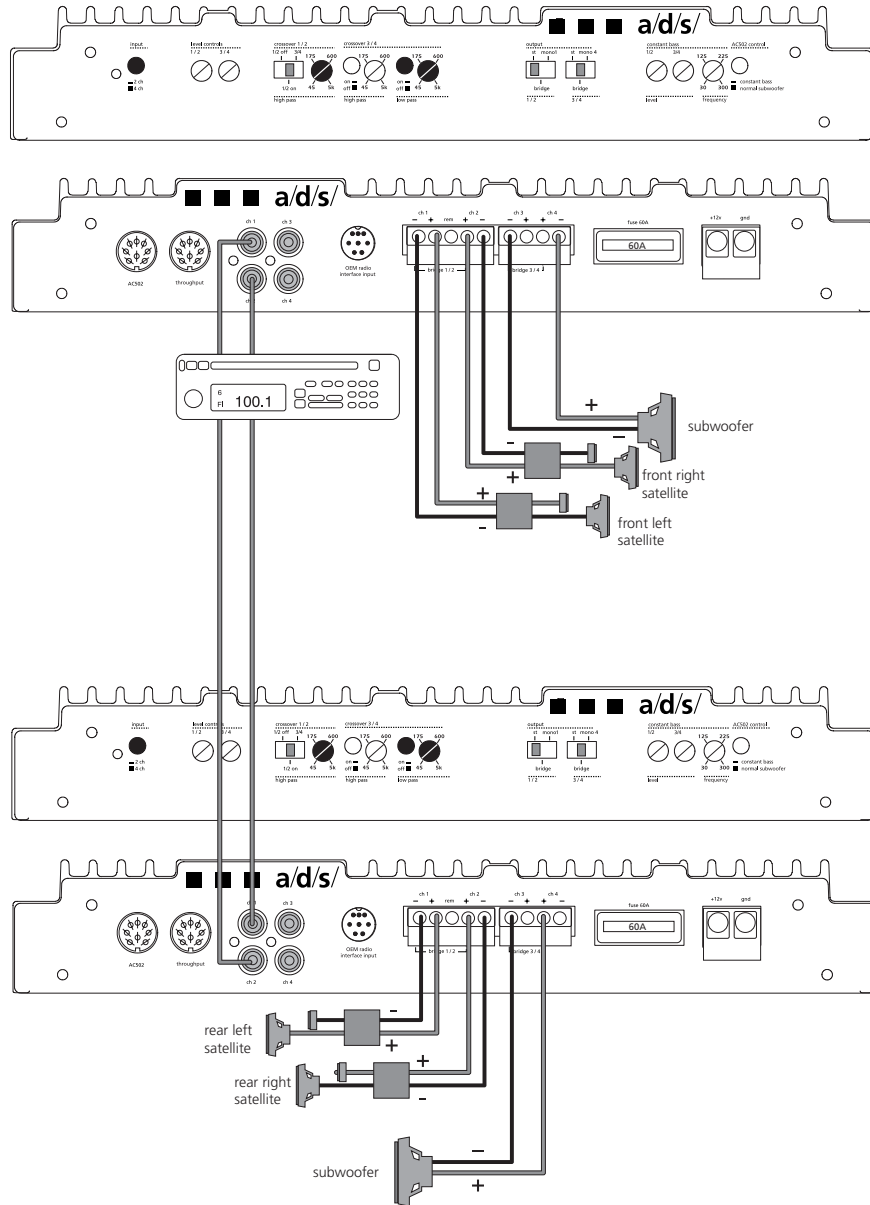

amplifier and crossover controls

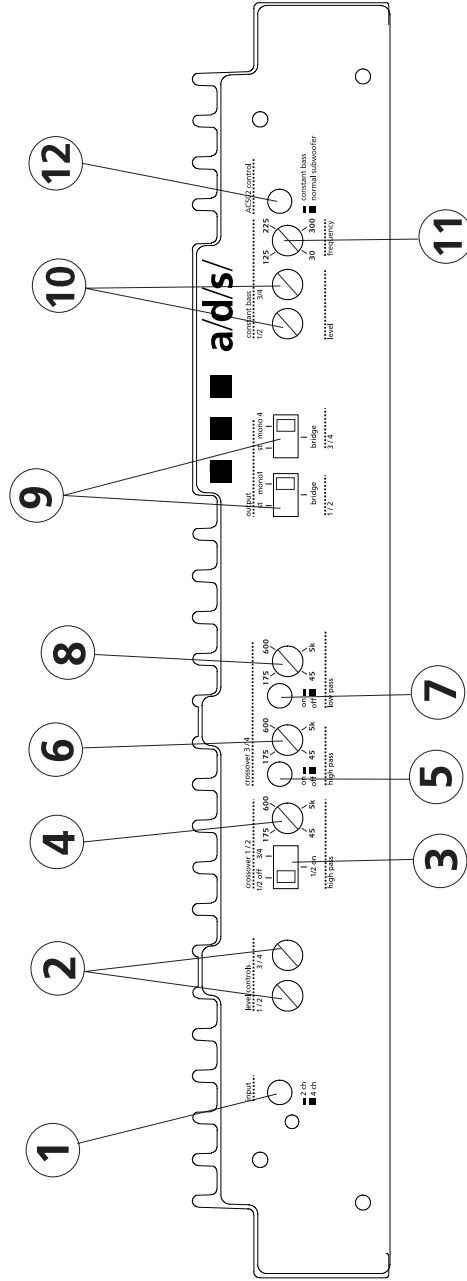

amplifier and crossover controls

1. 2ch/4ch input switch- Leave this switch OUT if you are using 4 channels of input. Push the switch IN if you have only 2 channels of input to send input 1 and 2 to channels 3 and 4, respectively. (see page 15)
2. level controls- Use these controls to match the input level from the source unit to each pair of amplifier channels. (see page 15)
3. crossover 1/2 switch- this switch will turn the channel 1/2 crossover on or off, or send channel 3 and 4 signal to channels 1 and 2, respectively. (see page 16)
4. crossover 1/2 frequency- This control sets the highpass crossover point for channels 1 and 2. (see page 16)
5. crossover 3/4 highpass switch- Push this switch IN to activate the channel 3/4 highpass crossover, or OUT to bypass the crossover. (see page 16)
6. crossover 3/4 highpass frequency- This control sets the highpass crossover point for channels 3 and 4. (see page 16)
7. crossover 3/4 lowpass switch- Push this switch IN to activate the channel 3/4 lowpass crossover, or OUT to bypass the crossover. (see page 16)
8. crossover 3/4 lowpass frequency- This control sets the lowpass crossover point for channels 3 and 4. (see page 16)
9. output switches- These switches determine whether the output is mono, bridged or stereo configuration for channels 1/2 and 3/4. (see page 15)
10. Constant Bass level- Use these controls to mix summed mono sub-bass information into channels 1/2 and 3/4. (see page 17)
11. Constant Bass frequency- This control sets the lowpass crossover point of the Constant Bass signal. (see page 17)
12. AC502 control- When using an optional AC502 remote level control, the AC502 will control the constant bass level when the switch is IN, or channel 3/4 level when the switch is OUT. (see page 17)

installation

1. Disconnect the battery ground cable. Reconnect the ground cable only after the installation is complete and the wiring has been checked to make sure that there are no problems. If your radio features a code type security system, be sure you know the code before disconnecting the battery!
2. Run a minimum AWG #8 power wire directly from the battery to the PowerPlate™ mounting location. Install a fuseholder at the battery end of this cable either within 18" of the battery or before the wire runs through any metal partitions. Do not install the fuse at this time.
3. Attach a minimum AWG #8 ground wire to a solid chassis ground point near the mounting location. Keep this wire as short as possible. Scrape all paint and primer off of the sheet metal at the ground point to ensure a good electrical connection. Attach the wire to the ground point with a nut, bolt and star washer.
4. Run the signal leads and remote turn-on leads from the head unit to the PowerPlate™ location. If using an internally powered radio or factory radio refer to the "signal sources" section for the proper wiring connections.
5. Install the speakers and run each of the speaker leads to the PowerPlate™ location. Connect the speaker, remote, and power wires to the appropriate terminals on the plug-in terminal blocks. Refer to the "controls and connections" or "system planning" sections for information on the proper connections. The speaker terminal blocks install with the set screws facing up and power terminal block installs with the set screws facing down.
6. Preset the 2/4 channel selector switch, crossover and channel mode switches, and crossover frequency switches to the desired positions. Refer to the "controls and connections" section for more information.
7. Adjust all amplifier input level controls to the 1/4 position.
8. Mount the amplifier into position and plug in the power and speaker terminals. Attach the input signal cables.
9. Reattach the battery ground cable.
10. Double check your switch and control settings. Install an 60 amp fuse in the fuseholder you have installed near the battery.
11. Turn on the signal source at a low volume level. Using the balance and fader controls, check to see that each channel is connected to the proper speakers. Make sure that the proper frequency range is being sent to each speaker if you are using the crossover features built into your PowerPlate™.
12. Adjust the input sensitivity and crossover frequencies as described in the "tuning" section.
13. Read the rest of this manual to get maximum enjoyment from your system.

controls and connections

power connections

- Use AWG #8 or larger power and ground cable.
- Install 60 amp fuse in the power wire within 18" of the battery.
- Keep the ground wire to a minimum length and attach solidly to a clean metal part of the vehicle. The addition of a .5 Farad to 1 Farad power supply capacitor, mounted as close as possible to the PowerPlate™, may improve performance in some systems.

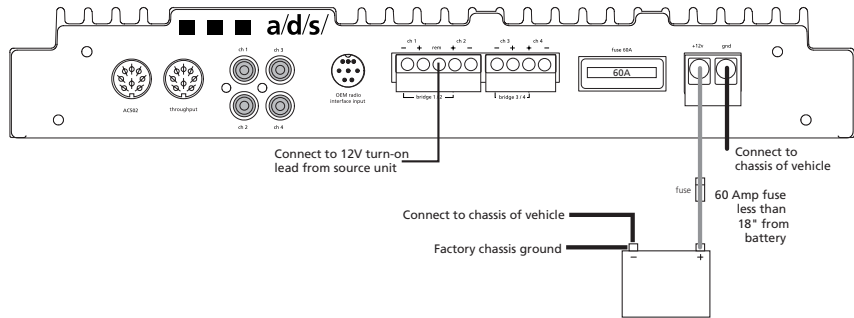

speaker connections for stereo configurations

Minimum recommended impedance is 2 stereo.
 Speaker terminals accept up to AWG #12 speaker wire.

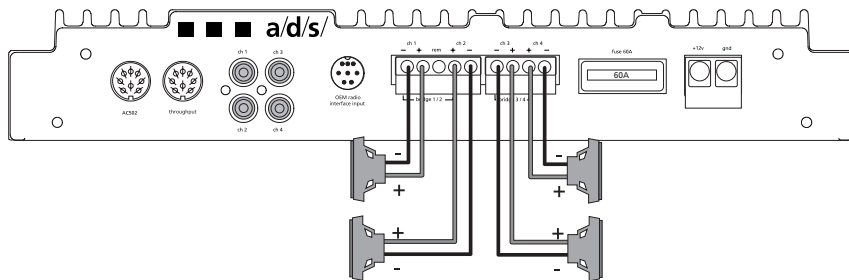

speaker connections for bridged configurations

Minimum recommended impedance is 4 when bridged to subwoofers and 4 when bridged to full range speakers. Speaker terminals accept up to AWG #12 speaker wire.

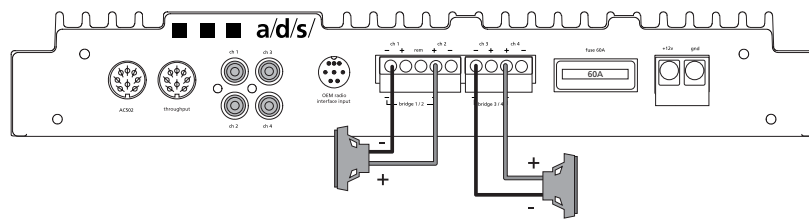

signal sources

Due to the wide input level adjustment range, all a/d/s/ PowerPlates™ can be driven with either a conventional preamplifier drive signal or the amplifier signal from a powered source unit. This makes the PowerPlate™ perfect for upgrading an OEM (Original Equipment Manufacturer) stereo system while retaining the factory installed radio.

Because of the high impedance of the a/d/s/ input stage, the factory radio drives an easy load. This ensures lower distortion levels than if it was driving speakers or a Line Output Converter accessory. As a result, a high quality factory installed radio can deliver high quality sound that is nearly as good as the sound from a high-end aftermarket source unit. The speaker outputs of the factory radio are simply connected to a mini-DIN adapter as shown below. From this point on, the signal can be treated exactly as you would a preamp-level signal, except that the input level controls on the PowerPlate™ will be set to a lower than usual level when you make your final adjustments.

Conventional aftermarket sources may be connected using standard shielded RCA cables from the source unit's preamp outputs to the PowerPlate™ inputs.

Note: When using 4 channels of input, be sure to configure the 2ch/4 ch input switch to 4ch input. Failure to do so may result in damage to the source unit.

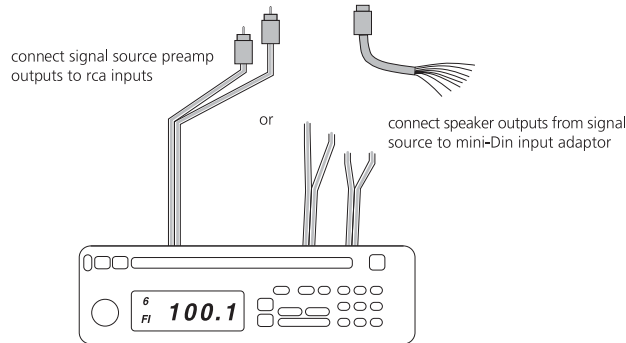
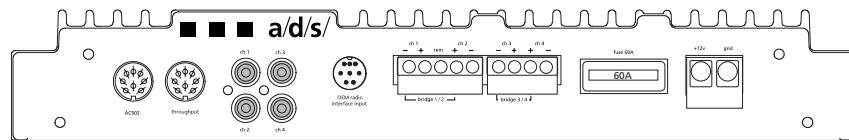

Pin	Wire Color	Connects to Head Unit
1	gray	front right +
2	violet/black	rear right -
3	white	front left +
4	gray/black	front right -
5	white/black	front left -
6	green	rear left +
7	green/black	rear left -

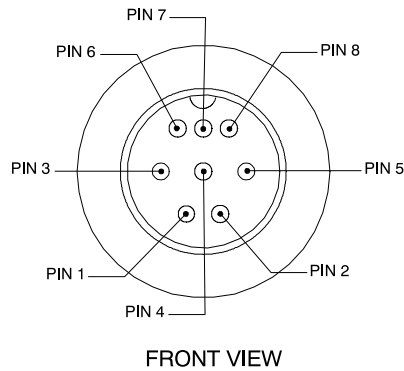
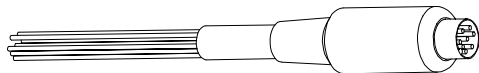

8 violet rear right +

internal signal routing

2-channel/4-channel input switch - routes RCA input from channels 1/2 to channels 3/4.

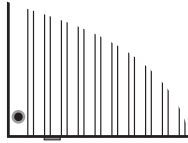

Switch in the engaged position.

When the switch is engaged, channel 1 input is routed to both amplifier channels 1 and 3 with input channel 2 routed to amplifier channels 2 and 4.

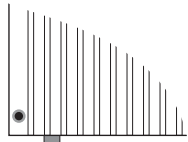
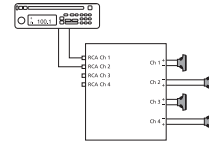

Switch in the disengaged position.

When the switch is disengaged, channels 1, 2, 3, and 4 receive signal individually from their respective inputs.

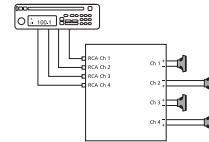

Level controls - Independent level controls for channels 1/2 and 3/4 adjust the input sensitivity from 100 mV to 8 VRMS.

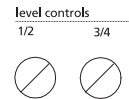

Output - Three position switches determine the output configuration. Each stereo pair of channels can be configured in either stereo, summed-bridged and bridged-mono.

When the switch is in the left position, the output channels are configured for stereo operation.

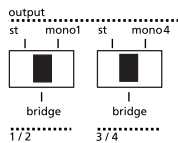
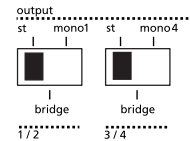

When the switch is in the center position, the output channels are configured for summed mono bridged operation by mixing the left and right input signals together.

When the switch is in the right position, the output channels are configured for a bridged mono output using a single RCA input. Ch 1 input is used for channels 1 & 2 and ch 4 input is used for channels 3 & 4.

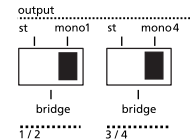

The throughput DIN connector allows easy access to Channels 1-4 inputs for routing to additional amplifiers in your system by using the optional AC202 (DIN to female RCA) or AC207 (DIN to male RCA) adapter.

DIN throughput connections:

- pin 1 ch 4
- pin 2 audio signal ground
- pin 3 ch 2
- pin 4 ch 3
- pin 5 ch 1
- pin 6 not used
- pin 7 not used
- pin 8 remote power control

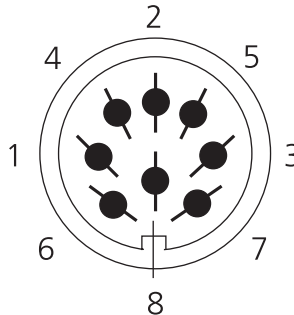

multi-cross™ crossover configuration

xover control 1/2- The crossover selection for channels 1 & 2 has three possibilities:

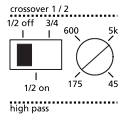

When the switch is in the left position, the crossover section of the amplifier is bypassed. Channels 1 & 2 output is full range.

When the switch is the center position, channels 1 & 2 are filtered through a 12dB per octave high-pass crossover that is infinitely variable from 45Hz to 5,000Hz.

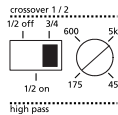
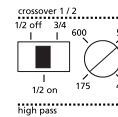

When the switch is in the right position, channels 1 & 2 receive signal from the crossover output of channels 3 & 4.

Note: When crossover 3/4 output is selected for channels 1/2, the 3/4 level control adjusts the output level for channels 1/2 and 3/4 simultaneously.

xover control 3/4- The crossover sections dedicated for channels 3 & 4 are activated by depressing the switch next to each frequency adjustment control. Both high-pass and low-pass crossovers are infinitely adjustable from 45Hz to 5,000Hz. The high-pass and low-pass sections may be used individually or together to create a bandpass filter.

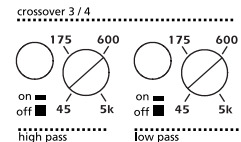

Note: When using both sections to create a bandpass filter, make sure you have selected a low-pass frequency which is higher than the high-pass frequency!

digital crossover frequency display

To facilitate quicker system tuning, we have incorporated a digital display that shows the crossover frequency for each crossover section, including the lowpass crossover for the constant bass circuit. Push the select switch to scroll through the different sections, and a blue led will indicate which crossover is currently displayed.

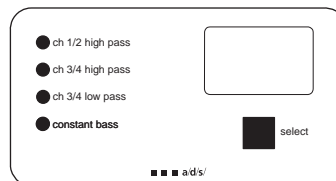

Constant bass circuit

To mix sub-bass information into channels 1/2 and 3/4, select a low-pass crossover point, and use the level controls to set the level of sub-bass signal sent to channels 1/2 and 3/4.

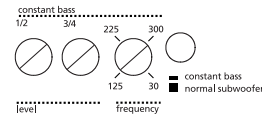

using the AC502 (optional)

The AC502 remote level control, available as an accessory from your a/d/s/ dealer, may be used with your PowerPlate™ to remotely adjust the level of channels 3/4, OR to remotely adjust the constant bass level. To use this feature, simply connect the AC502 into the DIN connector on the PQ40.2, and install the AC502 in the desired location. To adjust the constant bass level, locate the AC502 control switch on amplifier and push IN, or leave it OUT to control the level of channels 3/4. This remote capability can also be used on channels 1/2 when the PQ40.2 is used in the 2-channel bridged mode. Refer to the "adjustments" section for information on setting up the AC502 for the appropriate adjustment range.

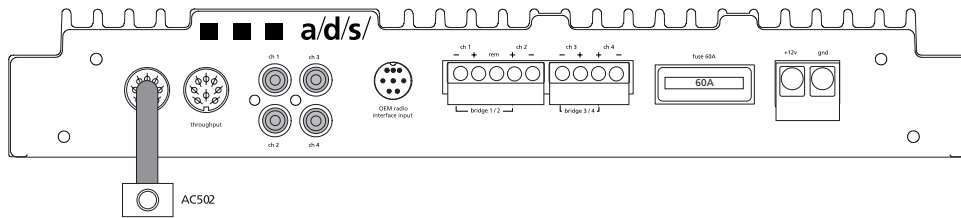

tuning

tuning the crossover

All of the crossover controls in the multi-cross™ crossover section are marked at four reference frequency points. These are 45Hz, 175Hz, 600Hz and 5,000Hz. Specific crossover points should be chosen based on the operating range recommended by the manufacturer of your speakers. The 85Hz position is a good starting point to use for subwoofer low-pass or midrange high-pass use. When bi-amping a/d/s/ loudspeaker components 2500Hz is a good starting point for the midrange low-pass, and 3500Hz is recommended as the tweeter high-pass. Once installed, you can fine tune the crossover points using your ears or with the aid of an RTA to achieve maximum performance. With any loudspeaker, minor deviations from the recommended frequency ranges may provide superior results, depending on your speaker locations and your vehicle's acoustics. Setting crossover frequencies higher than recommended will not cause damage and may provide good results. However, DO NOT set high-pass tweeter crossover points below the tweeters recommended operating range. Doing so will likely cause damage not covered by the manufacturer's warranty. If you are using non-a/d/s/ speakers, refer to the manufacturer's recommendation for selecting the proper crossover frequencies.



adjusting input sensitivity

The input sensitivity setting is important to ensure proper performance, low noise levels, and maximum system reliability. As a general rule, components at the "front end" of the system should be set as high as possible with the input sensitivity of the amplifier set as low as possible while still providing adequate volume levels. Using a high signal level from the source and a low input sensitivity setting on the amplifier will keep the background noise levels of the system low.

The following procedure will help you get the widest dynamic range from your system:

1. Start with the input level controls of your PowerPlate™ at the minimum (counterclockwise) position.
2. Set the tone controls and any controls on any equalizers or other signal processors to their flat or bypassed positions.
3. Set the input and output level controls, if any, on any associated equipment such as equalizers or outboard electronic crossover as recommended by their manufacturers.
4. Select a well recorded CD or Tape containing material recorded at a fairly high level. Musical content is not important except that the music chosen should be recorded such that any system distortion can be clearly heard, not masked by musical content.
5. Increase the source unit volume control about halfway. Increase the PowerPlate™ level control associated with the front full range (or midrange in a bi-amplified front system) until you can hear sound at a low but clear level.
6. While listening carefully for any signs of distortion, slowly increase the source unit volume control until you either hear the first signs of distortion or you can't turn it up any more. Back down on the volume control slightly until the distortion goes away. You have just found the maximum undistorted output level of your source unit. Do not exceed the level in normal operation, as doing so will just send a distorted signal to the rest of the system.
7. Returning to the PowerPlate™ level control associated with the front main speakers, slowly increase it until you reach the point where distortion just begins to appear. This will be at the point where either the amplifier reaches its maximum output level, or the speakers reach their output limits. Either way, you have just calibrated the system so that the maximum system output occurs at the same point as the maximum output from the source. This will give you minimum system noise yet the system will reach its maximum output capability.
8. Reduce the source unit volume to a comfortable listening level. With the balance and fader controls still centered, adjust the remaining level controls for the proper system balance. If you are adjusting a system with multiple amplifiers, it is easiest to adjust the controls in the following order: 1. Front speakers 2. Rear speakers 3. Subwoofers
9. If using an AC502 remote level control, adjust the subwoofer level with the AC502 in the mid position. This will give you the ability to boost the subwoofer level approximately 6dB when the AC502 is turned fully clockwise.
10. Double check your system levels by increasing the source unit volume control to the previously determined maximum position. If you hear distortion from any of the channels, reduce the PowerPlate™ input level for those channels until the distortion goes away.

Adjusting the input levels in this way will get maximum undistorted output from your system and will make it unlikely that you will cause damage to any of the components of your system by overpowering them.

troubleshooting

symptom	possible cause	action to take
no output	low or no remote turn-on input	check remote turn-on voltage output at amplifier and correct as needed
	fuse blown	check power wire integrity and reversed polarity, repair as needed and replace fuse
	power wires not connected	check power wire and ground connections and repair or replace as needed
	audio input not connected or no output from source	check input connections and signal integrity, repair or replace as needed
	speaker wires not connected	check speaker wires and repair or replace as needed
audio cycles on and off	speakers are blown	check system with known working speaker and repair or replace speakers as needed
	thermal protection engages when amplifier heatsink temperature exceeds 90° C	make sure there is proper ventilation for amplifier and improve ventilation as needed
	loose or poor audio input	check input connections and repair or replace as needed
distorted output	amplifier level sensitivity set too high; exceeding maximum output capability of amplifier	reset gain referring to the tuning section of the manual for detailed instructions
	impedance load to amplifier too low	check speaker impedance load if below 2 stereo or 4 mono rewire speakers to achieve a higher impedance
	shorted speaker wires	check speaker wire connections and repair or replace as needed
	speaker not connected to amplifier properly	check speaker wiring and repair or replace as needed refer to the installation section of this manual for detailed instructions
	internal crossover not set properly for speaker	reset crossovers referring to the multi-cross™ crossover configuration section of this manual

symptom	possible cause	action to take
distorted output (cont'd)	speakers are blown	check system with known working speakers and repair or replace as needed
poor bass response	speakers wired with wrong polarity causing cancellation at low frequencies	check speaker polarity and repair as needed
	crossover set incorrectly	reset crossovers referring to the multi-cross™ crossover configuration section of this manual for detailed instructions
battery fuse blowing	impedance load to amplifier too low	check speaker impedance load, if below 2 stereo or 4 mono rewire speakers to achieve a higher impedance
	short in power wire or incorrect power connections	check power and ground connections and repair as needed
	fuse used is smaller than recommended	replace with proper fuse size
	too much current being drawn	check speaker impedance load, if below 2 stereo or 4 mono rewire speakers to achieve a higher impedance
	short in power wire or incorrect	check power and ground connections and repair as needed
amplifier fuse blowing	too much current being drawn	check speaker impedance load, if below 2 stereo or 4 mono rewire speakers to achieve a higher impedance and replace with recommended fuse size check power and ground connections and repair as needed
	fuse used is smaller than recommended	replace with proper fuse size

specifications

amplifier section

PQ 40.2

power output 4 (watts) ¹	4 channel 4 x 100 2 channel 2 x 300
power output 2 (watts) ²	4 x 150
fuse type	60 A maxi
dimensions	13" x 16 1/8" x 2"
distortion all channels driven	<0.1% 20Hz to 20,000Hz
frequency response	±1dB 10Hz to 30,000Hz
signal-to-noise ratio full bandwidth @ rated output power	>90dB
damping factor @ output connector full bandwidth	>150
input sensitivity	100mV to 8Vrms for full output
input impedance	47 k
crossover section ³	
ch 1 & 2	high-pass 12dB/octave variable 45Hz- 5kHz
ch 3 & 4	high-pass & low-pass 12 dB/octave variable 45Hz- 5kHz
Constant Bass	low-pass 12dB/octave variable 30Hz- 300Hz

1 All channels driven, continuous FTC rated 4 load, 20Hz to 20,000Hz, <0.1% THD, power input voltage at 13.8DVC.

2 All channels driven, continuous FTC rated 2 load, 20Hz to 20,000Hz, <0.1% THD, power input voltage at 13.8DVC.

3 All channels are selectable with infinitely variable adjustments from 45Hz to 5,000Hz with a slope of 12dB/octave and a "Q" of .707.

warranty information

LIMITED TWO YEAR CONSUMER WARRANTY

Directed Electronics, Inc. promises to the original purchaser, to replace this product should it prove to be defective in workmanship or material under normal use, for a period of two years from the date of purchase by the dealer as indicated by the date code marking of the product **PROVIDED** the product was installed by an authorized Directed dealer. During this two year period, there will be no charge for this replacement **PROVIDED** the unit is returned to Directed, shipping pre-paid. If the unit is installed by anyone other than an authorized Directed dealer, the warranty period will be 1 year from date of purchase by the dealer as indicated by the date code marking of the product. During this 1 year period, there will be no charge for this replacement **PROVIDED** the unit is returned to Directed, shipping pre-paid. This warranty is non-transferable and does not apply to any unit that has been modified or used in a manner contrary to its intended purpose, and does not cover damage to the unit caused by installation or removal of the unit. This warranty is void if the product has been damaged by accident or unreasonable use, neglect, improper service or other causes not arising out of defects in materials or construction. **ALL WARRANTIES INCLUDING BUT NOT LIMITED TO EXPRESS WARRANTY, IMPLIED WARRANTY, WARRANTY OF MERCHANTABILITY, FITNESS FOR PARTICULAR PURPOSE, AND WARRANTY OF NON-INFRINGEMENT OF INTELLECTUAL PROPERTY ARE EXPRESSLY EXCLUDED TO THE MAXIMUM EXTENT ALLOWED BY LAW, AND DIRECTED NEITHER ASSUMES NOR AUTHORIZES ANY PERSON TO ASSUME FOR IT ANY LIABILITY IN CONNECTION WITH THE SALE OF THE PRODUCT. DIRECTED HAS ABSOLUTELY NO LIABILITY FOR ANY AND ALL ACTS OF THIRD PARTIES INCLUDING ITS AUTHORIZED DEALERS OR INSTALLERS.** Unit must be returned to Directed, postage pre-paid, with: consumer's name, telephone number, and address, authorized dealer's name and address, and product description. **IN ORDER FOR THIS WARRANTY TO BE VALID, YOUR UNIT MUST BE SHIPPED WITH PROOF OF INSTALLATION BY AN AUTHORIZED DIRECTED DEALER. ALL UNITS RECEIVED BY DIRECTED FOR WARRANTY REPAIR WITHOUT PROOF OF DIRECTED DEALER INSTALLATION WILL BE COVERED BY THE LIMITED 1 YEAR PARTS AND LABOR WARRANTY.** Note: This warranty does not cover labor costs for the removal and reinstallation of the unit.

BY PURCHASING THIS PRODUCT, THE CONSUMER AGREES AND CONSENTS THAT ALL DISPUTES BETWEEN THE CONSUMER AND DIRECTED SHALL BE RESOLVED IN ACCORDANCE WITH CALIFORNIA LAWS IN SAN DIEGO COUNTY, CALIFORNIA.

