

VIPER®

Model 160XVL

Installation Guide

NOTE: This product is intended for installation by a professional installer only! Any attempt to install this product by any person other than a trained professional may result in severe damage to a vehicle's electrical system and components.

Directed®
E L E C T R O N I C S

© 2006 Directed Electronics, Vista, CA
N562VL 07-06

table of contents

warning! safety first	3	1995 and newer vehicle anti-theft systems (immobilizers)	22
installation points to remember	4	passlock I and passlock II (PL-1 and PL-2) . .	23
after the installation	4	passkey III (PK-3), transponder-based systems	23
before beginning the installation	4	bypassing GM vehicle anti-theft systems (VATS) .	24
deciding on component locations	4	plug-in LED and valet/program switch	25
control module	4	programmer interface, 3-pin port	25
mounting the antenna	5	programming jumpers	26
valet/program switch	5	light flash (+)/(-)	26
status LED	6	tach threshold on/off	26
optional starter kill relay	6	transmitter/receiver learn routine	27
finding the wires you need	6	transmitter configurations	29
obtaining constant 12V	7	button configuration	29
finding the 12V switched ignition wire	7	operating settings learn routine	29
finding the starter wire	7	feature menus	31
finding a (+) brake light wire	8	menu #1	31
finding the accessory/heater wire	8	menu #2	32
finding the RPM input wire	9	feature descriptions	32
finding the wait-to-start bulb wire for diesels .	9	menu #1	32
wiring diagrams	10	menu #2	34
primary harness (H1) wiring diagram	10	tach learning	36
remote start ribbon harness wiring diagram . .	11	shutdown diagnostics	36
heavy gauge relay satellite wiring diagram . .	11	rapid resume logic	37
auxiliary harness (H2) wiring diagram	12	rear defogger control	38
remote start harness (H3) wiring diagram . .	12	timer mode	38
door lock harness (H4) wiring diagram	12	valet mode	39
remote start auxiliary harness wiring diagram	12	safety check	39
primary harness (H1) wire connection guide . .	13	troubleshooting	40
relay satellite wire connection guide	16	wiring quick reference guide	42
auxiliary harness (H2) wire connection guide .	17	relay satellite wiring quick reference guide . .	43
remote start harness (H3) wire connection guide	19		
neutral safety switch interface	20		
testing the neutral safety switch	21		

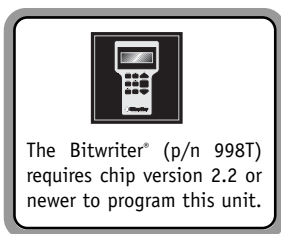

Bitwriter®, *Code Hopping™*, *Doubleguard®*, *ESP™*, *FailSafe®*, *Ghost Switch™*, *Learn Routine™*, *Nite-Lite®*, *Nuisance Prevention® Circuitry*, *Revenger®*, *Silent Mode™*, *Soft Chirp®*, *Stinger®*, *Valet®*, *Vehicle Recovery System®*, *VRS®*, and *Warn Away®* are all Trademarks or Registered Trademarks of Directed Electronics.

warning! safety first

The following safety warnings must be observed at all times:

- Due to the complexity of this system, installation of this product must only be performed by an authorized Directed dealer.
- When properly installed, this system can start the vehicle via a command signal from the remote control transmitter. Therefore, never operate the system in an area that does not have adequate ventilation. The following precautions are the sole responsibility of the user; however, authorized Directed dealers should make the following recommendations to all users of this system:
 1. Never operate the system in an enclosed or partially enclosed area without ventilation (such as a garage).
 2. When parking in an enclosed or partially enclosed area or when having the vehicle serviced, the remote start system must be disabled using the installed toggle switch.
 3. It is the user's sole responsibility to properly handle and keep out of reach from children all remote control transmitters to assure that the system does not unintentionally remote start the vehicle.
 4. **THE USER MUST INSTALL A CARBON MONOXIDE DETECTOR IN OR ABOUT THE LIVING AREA ADJACENT TO THE VEHICLE. ALL DOORS LEADING FROM ADJACENT LIVING AREAS TO THE ENCLOSED OR PARTIALLY ENCLOSED VEHICLE STORAGE AREA MUST AT ALL TIMES REMAIN CLOSED.**
- Use of this product in a manner contrary to its intended mode of operation may result in property damage, personal injury, or death. Except when performing the Safety Check outlined in this installation guide, (1) Never remotely start the vehicle with the vehicle in gear, and (2) Never remotely start the vehicle with the keys in the ignition. The user will be responsible for having the neutral safety feature of the vehicle periodically checked, wherein the vehicle must not remotely start while the car is in gear. This testing should be performed by an authorized Directed Electronics dealer in accordance with the Safety Check outlined in this product installation guide. If the vehicle starts in gear, cease remote start operation immediately and consult with the user to fix the problem immediately.
- After the remote start module has been installed, test the remote start module in accordance with the Safety Check outlined in this installation guide. If the vehicle starts when performing the Neutral Safety Shutdown Circuit test, the remote start unit has not been properly installed. The remote start module must be removed or properly reinstalled so that the vehicle does not start in gear. All installations must be performed by an authorized Directed Electronics dealer. **OPERATION OF THE REMOTE START MODULE IF THE VEHICLE STARTS IN GEAR IS CONTRARY TO ITS INTENDED MODE OF OPERATION. OPERATING THE REMOTE START SYSTEM UNDER THESE CONDITIONS MAY RESULT IN PROPERTY DAMAGE OR PERSONAL INJURY. IMMEDIATELY CEASE THE USE OF THE UNIT AND REPAIR OR DISCONNECT THE INSTALLED REMOTE START MODULE. DIRECTED ELECTRONICS WILL NOT BE HELD RESPONSIBLE OR PAY FOR INSTALLATION OR REINSTALLATION COSTS.**

installation points to remember

before beginning the installation

IMPORTANT! *This product is designed for fuel-injected, automatic transmission vehicles only. Installing it in a standard transmission vehicle is dangerous and is contrary to its intended use.*

- Please read this entire installation guide before beginning the installation. The installation of this remote start system requires interfacing with many of the vehicle's systems. Many new vehicles use low-voltage or multiplexed systems that can be damaged by low resistance testing devices, such as test lights and logic probes (computer safe test lights). Test all circuits with a high quality digital multi-meter before making connections.
- Do not disconnect the battery if the vehicle has an anti-theft-coded radio. If equipped with an air bag, avoid disconnecting the battery if possible. Many airbag systems will display a diagnostic code through their warning lights after they lose power. Disconnecting the battery requires this code to be erased, which can require a trip to the dealer.
- Remove the domelight fuse. This prevents accidentally draining the battery.
- Roll down a window to avoid being locked out of the car.

after the installation

- Test all functions. The "Using Your System" section of the Owner's Guide is very helpful when testing.
- Complete the vehicle *Safety Check* outlined in this manual prior to the vehicle reassembly.

deciding on component locations

control module

Things to remember when positioning the control module:

- Never place the control module in the engine compartment!
- The first thing a thief will do when hot-wiring a vehicle is to remove the driver's side under-dash panel to access the starter and ignition wires. You should therefore avoid placing the control module just behind the driver's side dash to prevent it from being easily disconnected during a theft attempt.
- When locating the control module, try to find a secure location that will not require you to extend the harness wires (they are 1.5 meters long).
- Keep the control module away from the heater core (or any other heat sources) and any obvious leaks.

- Some good control module locations are: Above the glove box, inside the center console, above the under-dash fuse box, or above the radio.

mounting the antenna

The antenna position should be discussed with the vehicle's owner prior to installation, since the antenna may be visible to the vehicle's operator. The best location for the antenna is centered high on either the front or rear windshield. For optimal range, the antenna should be mounted vertically. It can be mounted horizontally in relation to the windshield or under the dashboard away from metal, but range will be diminished. Metallic window tint can also affect range, so this should be a consideration when determining the mounting location.

After determining the best mounting location, follow these steps:

1. Clean the mounting area with a quality glass cleaner or alcohol to remove any dirt or residue.
3. Mount the antenna using the supplied double-sided tape.
4. Route the antenna cable to the control module and plug it into the antenna connector.

IMPORTANT! To achieve the best possible range, DO NOT leave the antenna cable bundled under the dash. Always extend the cable full length during installation, regardless of the antenna mounting location.

valet/program switch

Ensure that the location you pick for this switch has sufficient clearance to the rear. The switch should be well hidden. It should be placed so that passengers or stored items (such as items placed in a glove box or center console) cannot accidentally bump it. The switch fits in a $\frac{9}{32}$ -inch hole.

IMPORTANT! When the vehicle is delivered, please show the user where the Valet/Program switch is located and how to disarm the system using the switch.

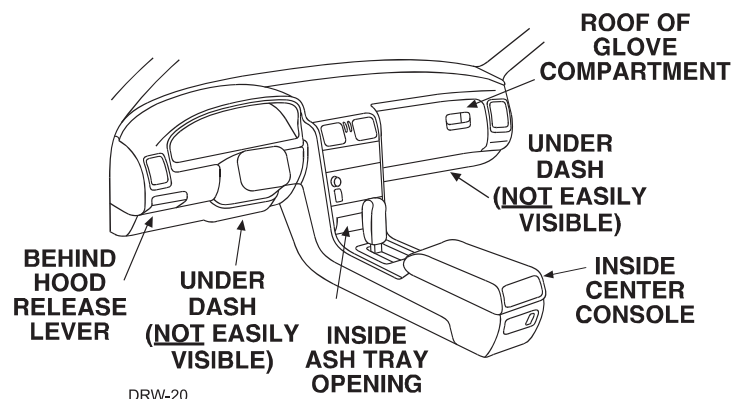

status LED

Things to remember when positioning the status LED:

- It should be visible from both sides and the rear of the vehicle, if possible.
- It needs at least 1/2-inch clearance to the rear.
- It is easiest to use a small removable panel, such as a switch blank or a dash bezel. Remove it before drilling your 9/32-inch hole.
- Use quick-disconnects near the LED wires if the panel is removable. This lets mechanics or other installers remove the panel without having to cut the wires.

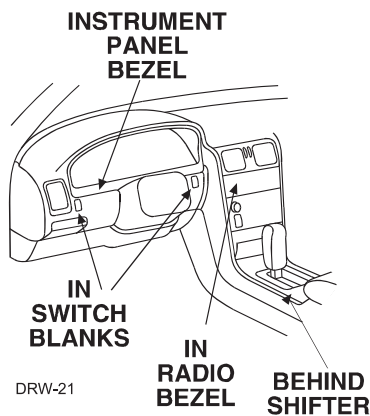

optional starter kill relay

If the optional starter kill relay or its connections are immediately visible upon removal of the under-dash panel, they can easily be bypassed. Always make the relay and its connections difficult to discern from the factory wiring! Exposed yellow butt connectors do not look like factory parts, and will not fool anyone! For this reason, routing the starter kill wires away from the steering column is recommended.

finding the wires you need

Now that you have determined where each component will be located, your next step is to find the wires in the vehicle that the security system will be connected to.

IMPORTANT! Do not use a 12V test light to locate these wires! All testing described in this manual assumes the use of a digital multimeter.

obtaining constant 12V

We recommend two possible sources for 12V constant: The (+) terminal of the battery, or the constant 12V supply to the ignition switch. Always install a fuse within 12 inches of this connection. If the fuse will also be powering other circuits, such as door locks, a power window module, or a Nite-Lite® headlight control system, fuse accordingly.

IMPORTANT! Do not remove the fuse holder on the red wire. It ensures that the control module has its own fuse, of the proper value, regardless of how many accessories are added to the main power feed.

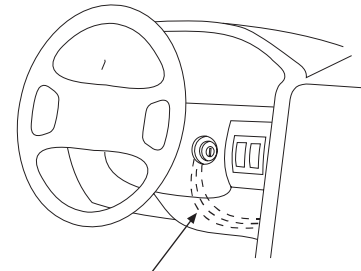
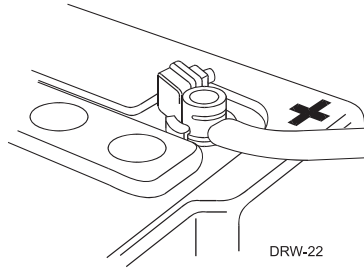
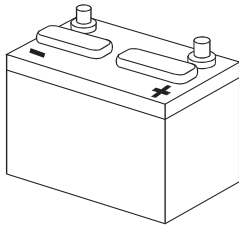

CONSTANT 12V DRW-23

finding the 12V switched ignition wire

The ignition wire is powered when the key is in the run or start position. This is because the ignition wire powers the ignition system (spark plugs, coil) as well as the fuel delivery system (fuel pump, fuel injection computer). Accessory wires lose power when the key is in the start position to make more current available to the starter motor.

How to find (+)12V ignition with your multimeter:

1. Set to DCV or DC voltage (12V or 20V is fine).
2. Attach the (-) probe of the meter to chassis ground.
3. Probe the wire you suspect of being the ignition wire. The steering column harness or ignition switch harness is an excellent place to find this wire.
4. Turn the ignition key switch to the run position. If your meter reads (+)12V, go to the next step. If it does not read (+)12V, probe another wire.
5. Now turn the key to the start position. The meter display should stay steady, not dropping by more than a few tenths of a volt. If it drops close to or all the way to zero, go back to Step 3. If it stays steady at (+)12V, you have found an ignition wire.

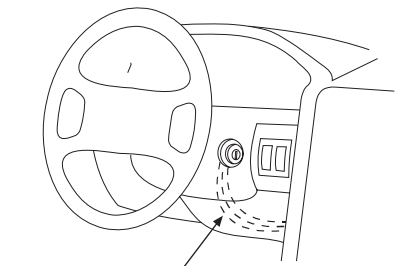

IGNITION DRW-24

finding the starter wire

The starter wire provides 12V directly to the starter or to a relay controlling starter. In some vehicles, it is necessary to power a cold start circuit. A cold start circuit will test exactly like a starter circuit, but it does not

control the starter. Instead, the cold start circuit is used to prime the fuel injection system for starting when the vehicle is cold.

How to find the starter wire with your multimeter:

1. Set to DCV or DC voltage (12V or 20V is fine).
2. Attach the (-) probe of the meter to chassis ground.
3. Probe the wire you suspect of being the starter wire. The steering column is an excellent place to find this wire. Remember you do not need to interrupt the starter at the same point you test it. Hiding your optional starter kill relay and connections is always recommended.
4. Turn the ignition key switch to the start position. Make sure the car is not in gear! If your meter reads (+)12V, go to the next step. If it doesn't, probe another wire.
5. Cut the wire you suspect of being the starter wire.
6. Attempt to start the car. If the starter engages, reconnect it and go back to Step 3. If the starter does not turn over, you have the right wire.

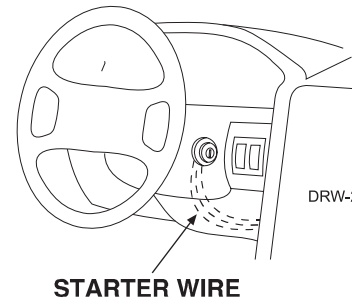

finding a (+) brake light wire

Most vehicles use a (+) brake light circuit. The (+) brake light wire is often found near the brake pedal. The same wire can often be accessed in the kick panel or running board.

How to find a (+) brake light wire with your multimeter:

1. Set to DCV or DC voltage (12V or 20V is fine).
2. Attach the (-) probe of the meter to chassis ground.
3. Probe the wire you suspect of being the brake light wire.
4. Press the brake pedal. If your meter shows (+)12V, release the brake pedal and make sure it goes back to zero.
5. If it does return to zero, this is the correct brake wire.

finding the accessory/heater wire

An accessory/heater wire will show +12V when the key is in the accessory and run positions. It will not show +12V during the cranking cycle. There will often be more than one accessory wire in the ignition harness. The correct accessory wire will power the vehicle's climate control system. Some vehicles may have separate wires for the blower motor and the air conditioning compressor. In such cases, it will be necessary to add a relay to power the second accessory wire.

finding the RPM input wire

To test for a tachometer wire, a multimeter capable of testing AC voltage must be used. The tachometer wire will show between 1V and 6V AC. In multi-coil ignition systems, the system can learn individual coil wires. Individual coil wires in a multi-coil ignition system will register lower amounts of AC voltage. Also, if necessary, the system can use a fuel injector control wire for engine speed sensing. Common locations for a tachometer wire are the ignition coil itself, the back of the gauges, engine computers, and automatic transmission computers.

IMPORTANT! Do not test tachometer wires with a test light or logic probe. The vehicle will be damaged.

How to find a tachometer wire with your multimeter:

1. Set to ACV or AC voltage (12V or 20V is fine).
2. Attach the (-) probe of the meter to chassis ground.
3. Start and run the vehicle.
4. Probe the wire you suspect of being the tachometer wire with the red probe of the meter.
5. If this is the correct wire the meter will fluctuate with the rpm of the motor and read between 1V and 6V.

finding the wait-to-start bulb wire for diesels

In diesel vehicles it is necessary to interface with the wire that turns on the WAIT TO START light in the dashboard. This wire illuminates the bulb until the vehicle's glow plugs are properly heated. When the light goes out the vehicle can be started. This wire is always available at the connector leading to the bulb in the dashboard. It can also be found at the Engine Control Module (ECM) in many vehicles.

To test and determine the polarity of this wire:

1. Set your multimeter to DCV or DC voltage (12 or 20V is fine).
2. Attach the (+) probe of the meter to (+)12V.
3. Probe the wire that you suspect leads to the bulb with the (-) probe of the meter.
4. Turn the ignition switch to the ON position.
5. If the meter indicates 12 volts until the light goes out you have isolated the correct wire and the wire's polarity is negative (ground while the bulb is on).
6. If the meter reads zero volts until the light goes out and then reads 12 volts, you have isolated the correct wire and the wire's polarity is positive.

wiring diagrams

primary harness (H1) wiring diagram

The primary harness supplied with this unit is the standard 12-pin harness used by Directed Electronics security systems. Three wires in the plug are not used. The upgrade from this unit to a security system would simply require unplugging and exchanging control units and connecting the necessary wires to the vehicle. The functions of all the wires that are used in the primary harness are outlined in the following wiring diagram and the wire connections are described in the wire connection guides.

H1/1	RED/WHITE	(-) 200 mA CHANNEL 2 VALIDITY OUTPUT
H1/2	RED	(+) CONSTANT POWER INPUT
H1/3	BROWN	(-) HORN HONK OUTPUT
H1/4		NO FUNCTION
H1/5	BLACK	(-) CHASSIS GROUND INPUT
H1/6		NO FUNCTION
H1/7	BLUE	(-) SECOND UNLOCK OUTPUT
H1/8		NO FUNCTION
H1/9	BLACK/WHITE	(-) 200 mA DOMELIGHT SUPERVISION OUTPUT
H1/10	WHITE/BLUE	(-) REMOTE START ACTIVATION INPUT
H1/11	WHITE	(+)/(-) SELECTABLE LIGHT FLASH OUTPUT
H1/12	ORANGE	(-) 500 mA ARMED OUTPUT

remote start ribbon harness wiring diagram

1	PINK/WHITE	(-) 200 mA PROGRAMMABLE ACC/IGN OUTPUT
2	YELLOW	(+) IGNITION INPUT TO REMOTE START
3	PINK	(-) 200 mA IGNITION RELAY TURN-ON
4	ORANGE	(-) 200 mA ACCESSORY RELAY TURN-ON
5	PURPLE	(-) 200 mA STARTER RELAY TURN-ON
6	ORANGE/BLACK	(-) ANTI-GRIND OUTPUT/GROUND WHEN ARMED OUTPUT
7	BLUE	(-) 200 mA STATUS OUTPUT

heavy gauge relay satellite wiring diagram

1	PURPLE	(+) STARTER OUTPUT TO STARTER (STARTER SIDE)
2	GREEN	STARTER INPUT FROM IGNITION (KEY SIDE)
3	RED	(+) (30A) HIGH CURRENT 12V INPUT
4	ORANGE	(+) OUTPUT TO ACCESSORY CIRCUIT
5	RED	(+) (30A) HIGH CURRENT 12V INPUT
6	PINK	(+) OUTPUT TO IGNITION CIRCUIT
7	RED/WHITE	HIGH CURRENT 12V INPUT
8	PINK/WHITE	(+) OUTPUT TO SECOND IGNITION/ACCESSORY CIRCUIT

auxiliary harness (H2) wiring diagram

H2/1	VIOLET/BLACK	(-) CHANNEL 4 OUTPUT
H2/2	GREEN/WHITE	(-) FACTORY REARM OUTPUT
H2/3	GRAY/BLACK	(-) WAIT-TO-START INPUT
H2/4	LIGHT GREEN/BLACK	(-) FACTORY ALARM DISARM

remote start harness (H3) wiring diagram

H3/1	BLACK/WHITE	(-) NEUTRAL SAFETY SWITCH INPUT
H3/2	VIOLET/WHITE	TACHOMETER INPUT WIRE
H3/3	BROWN	(+) BRAKE SWITCH SHUTDOWN WIRE
H3/4	GRAY	(-) HOOD PINSWITCH SHUTDOWN WIRE
H3/5	BLUE/WHITE	(-) 200 mA 2ND STATUS/REAR DEFOGGER - LATCHED/PULSED

door lock harness (H4) wiring diagram

H4/1	BLUE	(+) LOCK (-) UNLOCK
H4/2		NO FUNCTION
H4/3	GREEN	(-) LOCK (+) UNLOCK

Note: Refer to TechTip 1041 for wiring information.

remote start auxiliary harness wiring diagram

1	BLUE	(-) 200 mA STATUS OUTPUT
2	ORANGE	(-) 200 mA ACCESSORY RELAY TRIGGER
3	PURPLE	(-) 200 mA STARTER RELAY TRIGGER
4	PINK	(-) 200 mA IGNITION RELAY TRIGGER

primary harness (H1) wire connection guide

H1/1 RED/WHITE Channel 2, (-) 200 mA output

When the system receives the code controlling Channel 2, for longer than 1.5 seconds, the RED/WHITE wire will supply an output as long as the transmission continues. This is often used to operate a trunk/hatch release or other relay-driven function.

IMPORTANT! Never use this wire to drive anything except a relay or low-current input! The transistorized output can only supply 200 mA of current. Connecting directly to a solenoid, motor, or other high-current device will cause it to fail.

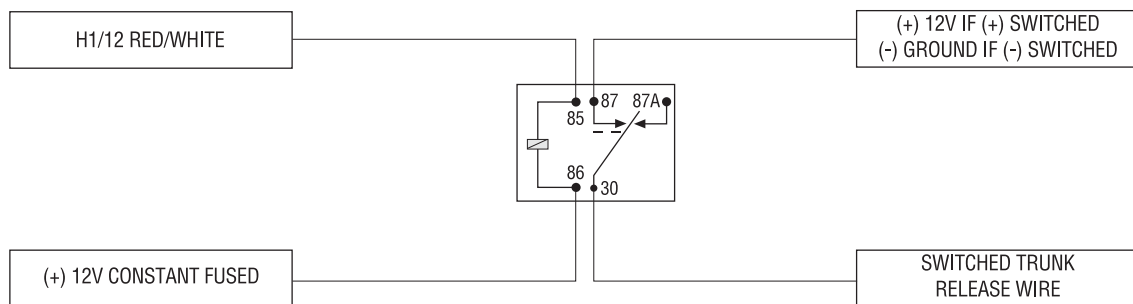

H1/2 RED (+)12V constant power input

Before connecting this wire, remove the supplied fuse. Connect to the battery positive terminal or the constant 12V supply to the ignition switch.

NOTE: Always use a fuse within 12 inches of the point you obtain (+)12V. Do not use the 10A fuse in the harness for this purpose. This fuse is intended to protect the module.

H1/3 BROWN (-) horn honk output

This wire supplies a (-) 200 mA output that can be used to honk the vehicle horn. It outputs a single pulse when locking the doors with the remote, and two pulses when unlocking with the remote. This wire will also output pulses for 30 seconds when the Panic Mode is activated. If the vehicle has a (+) horn circuit, an optional relay can be used to interface with the system, as shown below.

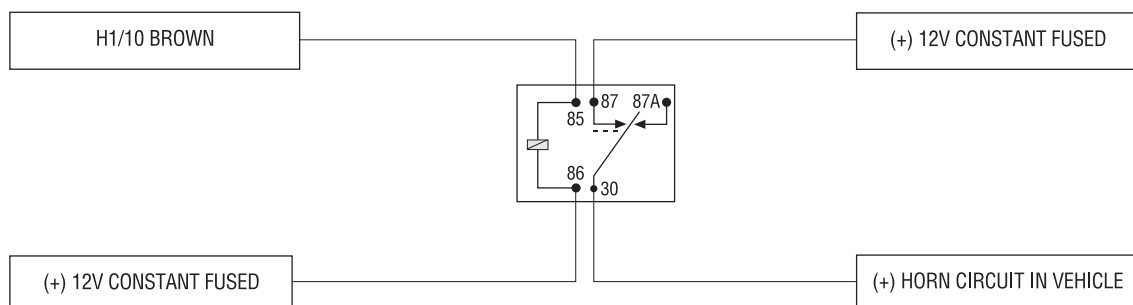

H1/5 BLACK (-) chassis ground connection

Remove any paint and connect this wire to bare metal, preferably with a factory bolt rather than your own screw. (Screws tend to either strip or loosen with time.) We recommend grounding all your components, including the siren, to the same point in the vehicle.

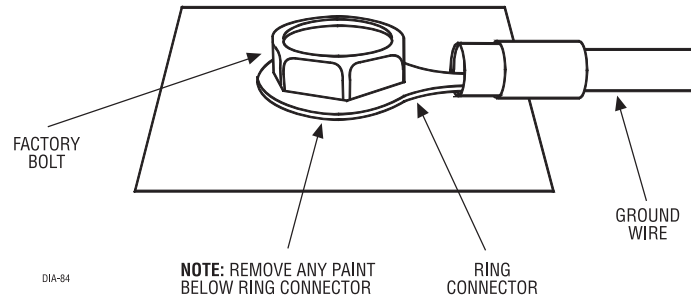

H1/7 BLUE second unlock

This output is used for progressive door unlock. A progressive unlock system unlocks the driver's door when the unlock (disarm) button is pressed and unlocks the passenger doors if the unlock (disarm) button is pressed again within 15 seconds after unlocking the driver's door. The BLUE wire outputs a low current (-) pulse on the second press of the unlock button of the transmitter. This negative unlock output is used to unlock the passenger doors.

NOTE: The second unlock output feature is not available if the double pulse unlock feature is turned on.

H1/9 BLACK /WHITE (-) 200 mA domelight supervision output

Connect this wire to the optional domelight supervision relay as shown below:

IMPORTANT! This output is only intended to drive a relay. It cannot be connected directly to the domelight circuit because the output cannot support the current draw of one or more light bulbs.

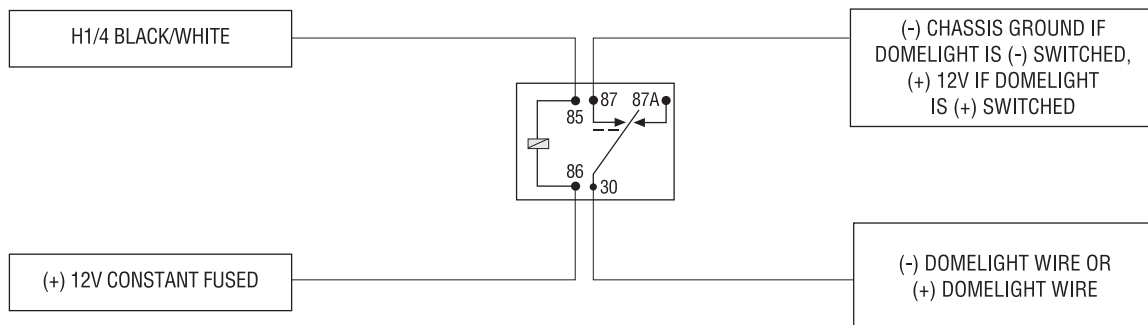

H1/10 WHITE/BLUE (-) remote start activation input

This input comes from the factory set to 2 activation pulses. This means that it is necessary to have 2 consecutive ground pulses on the white/blue wire for the remote start to activate or to deactivate. The same holds true for the remote control activation when set to a two pulse setting it is necessary to press the  button twice for the remote start to activate or deactivate.

NOTE: When the activation pulse count can be programmed to 1, 2, or 3 pulses when changed it will affect both activation inputs; the White/Blue wire and the remote control activation.

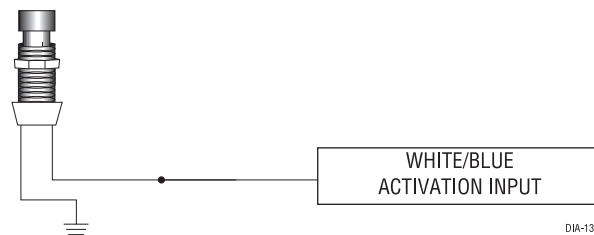

H1/11 WHITE (+/-) selectable light flash output

As shipped, this wire should be connected to the (+) parking light wire. If the light flash polarity jumper is moved to the opposite position (see *Internal Programming Jumpers* section), this wire supplies a (-)200 mA output. This is available for driving (-) light control wires in Toyota, Lexus, BMW, some Mitsubishi, some Mazda, and various other models.

(+) Positive Light Flash Output

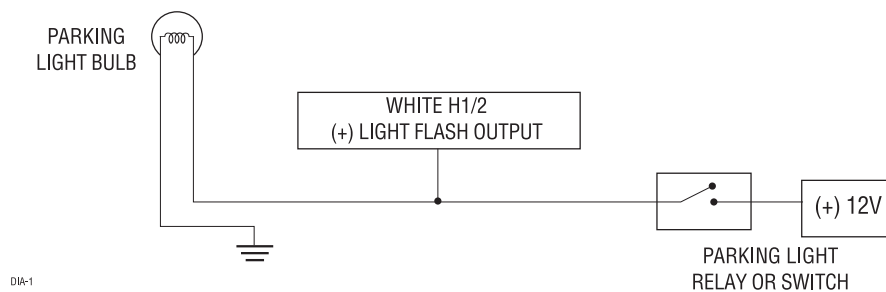

(-) Light Flash Output

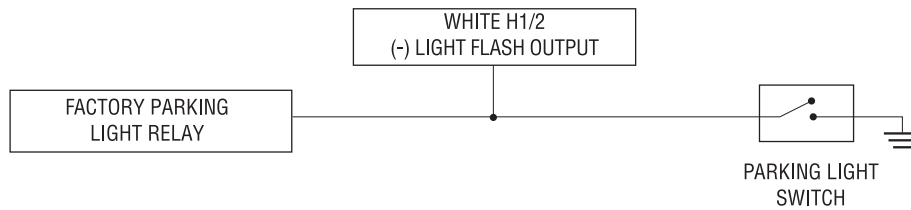

NOTE: For parking light circuits that draw 10 amps or more, the internal jumper must be switched to a (-) light flash output. (See the Internal Programming Jumper section of this guide.) P/N 8617 or a standard automotive SPDT relay must be used on the H1/2 light flash output harness wire.

H1/12 ORANGE (-) ground-when-armed output

This wire supplies a (-)500 mA ground as long as the system is armed. This output ceases as soon as the system is disarmed. The orange wire may be wired to an optional Directed Electronics 8618 starter kill relay.

relay satellite wire connection guide

All except the red heavy gauge wires leading from the relay satellite are used to energize high current circuits in the vehicle. It is crucial that these connections are made correctly so that they are capable of handling the current demands. For this reason, scotch locks, T-taps and other such connectors should not be used.

PURPLE (+) starter output

After cutting the starter wire connect the PURPLE wire to the end going to the starter motor.

GREEN starter kill

After cutting the starter wire connect the GREEN wire to the end going to the key side of the ignition.

RED (2) (+)12V input for relays

Remove the two 30 amp fuses prior to connecting these wires and do not replace them until the satellite has been plugged into the control module. These wires are the source of current for all the circuits the relay satellite will energize. They must be connected to a high current source. Since the factory supplies (+) 12V to the key switch that is used to operate the motor, it is recommended that these wires be connected there.

NOTE: If the factory supplies two separate (+) 12V feeds to the ignition switch, connect one RED wire of the satellite to each feed at the switch.

ORANGE (+) accessory output

Connect this wire to the accessory wire in the vehicle that powers the climate control system.

PINK (+) ignition output

Connect this wire to the ignition wire in the vehicle.

PINK/WHITE (+) output to second ignition/accessory circuit

Connect this wire to the second ignition or accessory wire in the vehicle (selectable menu feature 2-9).

RED/WHITE 12 V input

If additional current capacity is needed cut this wire, add a fuse adequate for the circuit to be supplied, and connect to an additional 12V source.

auxiliary harness (H2) wire connection guide

H2/1 VIOLET/BLACK (-) channel 4 output

This wire provides 200 mA programmable output. (See *Feature Descriptions* section of this guide.)

H2/2 GREEN/WHITE factory rearm output

This wire sends a negative pulse every time the remote start shuts down or the doors are locked. This can be used to pulse the arm wire of the vehicle's factory anti-theft device. Use a relay to send a (-) or (+) pulse to the arm wire.

H2/3 GRAY/BLACK (-) diesel wait-to-start bulb input

Connect this wire to the wire in the vehicle that sends the signal to turn on the WAIT-TO-START bulb in the dashboard. In most diesels the wire is negative (ground turns on the bulb) and the GRAY/BLACK can be directly connected to the wire in the vehicle. If the vehicle uses a positive wire (12V to turn on the bulb) a relay must be used to change the polarity. (See *Finding the Wait-To-Start Bulb Wire For Diesels* section of this guide.) Here are some common colors of this wire:

- Chevrolet and GMC trucks: Light Blue or Dark Blue
- Ford Trucks: Black/Pink
- Dodge Ram Trucks: Orange/Black or Black/Orange

NOTE: A 1-amp diode must be installed in line on the factory wire between the wait-to-start indicator and the ECM. (See the following diagram for details.)

(-) WAIT TO START WIRE

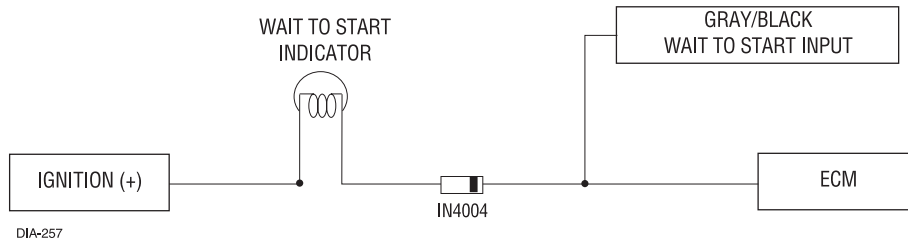

(+) WAIT TO START WIRE

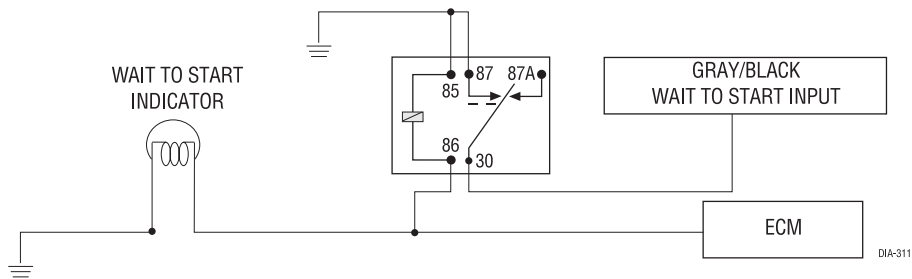

H2/4 LIGHT GREEN/BLACK (-) factory alarm disarm

This wire sends a negative pulse every time the remote start is activated or the doors are unlocked. This can be used to pulse the disarm wire of the vehicle's factory anti-theft device. Use a relay to send a (-) or (+) pulse to the disarm wire as shown in the following diagrams.

Relay for Negative (-) Disarm Wire

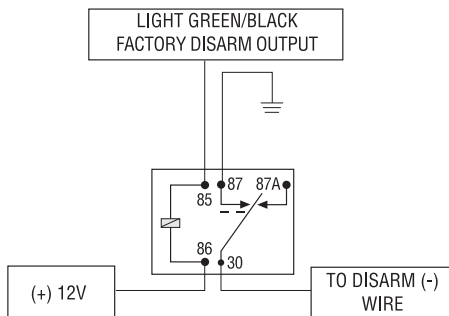

Relay for Positive (+) Disarm Wire

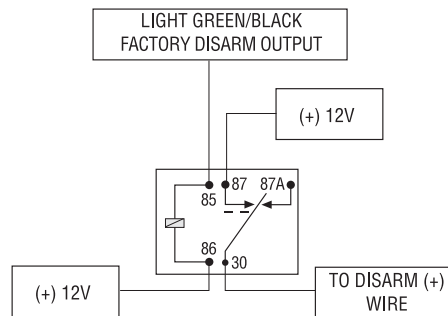

remote start harness (H3) wire connection guide

H3/1 BLACK/WHITE neutral safety switch input

Connect this wire to the toggle (override) switch as shown in Figure A. Connect the other wire from the toggle switch to the PARK/NEUTRAL switch in the vehicle. This wire will test with ground with the gear selector either in PARK or NEUTRAL. This will prevent the vehicle from accidentally being started while in a drive gear. This input MUST rest at ground in order for the remote start system to operate. Connected properly the vehicle will only start while in PARK or NEUTRAL.

In some vehicles, the PARK/NEUTRAL position switch activates a factory starter lock out that will not allow the starter to operate in a drive gear. In these vehicles, connect this wire to the toggle switch as shown in Figure B. Connect the other wire from the toggle switch to chassis ground.

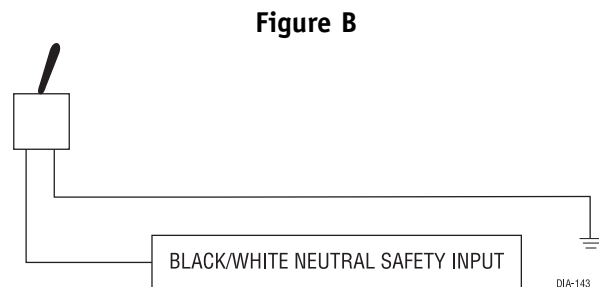
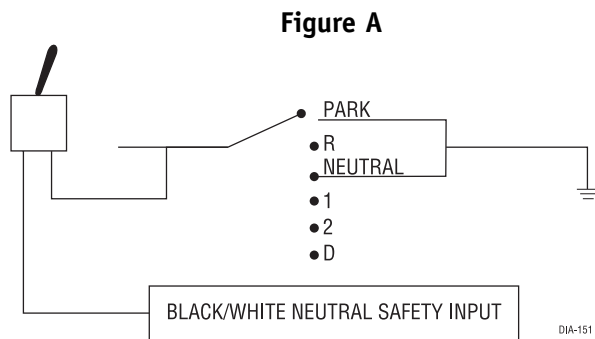

IMPORTANT! Always perform the Vehicle Safety Check section of this guide to verify that the vehicle cannot be started in ANY drive gear and that the override switch is functioning properly.

H3/2 VIOLET/WHITE tachometer input

This input provides the module with information about the engine's revolutions per minute (RPMs). It can be connected to the negative side of the coil in vehicles with conventional coils. In multi-coil and high energy ignition systems locating a proper signal may be more difficult. (See *Installation Points to Remember* section of this guide for finding the tachometer wire.) Once connected, you must teach the system the tach signal. (See *Tach Learning* section of this guide.)

H3/3 BROWN (+) brake switch input

This wire MUST be connected to the vehicle's brake light wire. This is the wire that shows (+) 12V when the brake pedal is pressed. The remote start will be disabled or shut down any time the brake pedal is pressed.

H3/4 GRAY (-) hood pinswitch input

This wire MUST be connected to hood pinswitch. This input will disable or shut down the remote start when the hood is opened.

H3/5 BLUE/WHITE status/defogger output

This wire supplies a 200mA output as soon as the module begins the remote start process. The H3/1 BLUE wire can also be used to activate the defogger trigger (latched/pulsed) 10-seconds after the remote start engages. (See the *Feature Descriptions* section in this guide for details about programming this output.)

neutral safety switch interface

Some vehicles combine the column shift mechanism and the mechanical neutral safety switch into one mechanical part. In these vehicles, it is impossible to interface the remote start system before the neutral safety switch. With this type of vehicle, if the vehicle is left in a drive gear and the remote start system is activated, the vehicle will move and may cause damage to persons or property.

According to available information, vehicles known to be manufactured this way are most General Motors trucks, sport utility vehicles and column shifting passenger vehicles. Available information also indicates that pre-1996 Dodge Dakota pickups with 2.5 liter motors are also manufactured this way.

GM vehicles that have the neutral safety switch built into the column shifter can usually be identified by a purple starter wire. Typically, vehicles that use an outboard mechanical switch use a yellow wire from the ignition switch to the mechanical switch and a purple wire from the mechanical switch to the starter itself. Remember, this is only a rule of thumb and is not intended as a substitute for proper testing.

We suggest the following procedure to test for vehicles manufactured in this way.

NOTE: *You must complete the remote start system installation before doing the following test. Ensure that the remote start system is functioning normally. This includes connecting to the brake as a shut-down.*

testing the neutral safety switch

1. Make sure there is adequate clearance to the front and rear of the vehicle because it may move slightly.
2. Make sure the hood is closed and there are no remote start shut-downs active.
3. Set the emergency brake.
4. Turn the key to the "run" position, this will release the shifter.
5. Place the car in drive (D).
6. Place your foot directly over the brake pedal, but do not depress it. Be ready to step on the brake if the starter engages.
7. Activate the remote start system.
8. If the starter engages, immediately depress the brake to shut the remote start system down. If the starter does not engage, no additional safety system is required.

If the starter engages and the vehicle is a General Motors product or Dodge Dakota pickup, refer to the following text and diagrams for an alternative shut-down method which will prevent the starter from engaging. If the vehicle is not a General Motors product or a Dodge Dakota pickup, please call Directed Electronics Technical Support for an alternative shut-down method. Do not return the vehicle to the customer until this feature is properly installed!

Every vehicle built this way requires that the shifter be placed in park to remove the keys from the ignition. As a result, it is possible to use the key-in-ignition sense switch to prevent remote starting if the keys are in the ignition. The diagrams in this section illustrate how to accomplish this.

Diagram A applies to all General Motors vehicles at the time of publication of this guide. Diagram B applies to all pre-1996 Dodge Dakota pickup trucks with 2.5 liter motors. This solution has one side effect - if the customer inserts the key in the ignition with the driver's door open, the remote start system will shut down. If this interface is used it is important to inform the customer to close the driver's door before inserting the key into the ignition when the remote start is active. This will allow the customer to turn the key on and shut the remote start down by pressing the brake without the key sense wire shutting down the unit prematurely.

In addition, you must connect a tan (+) shut-down input to the yellow wire on the relay satellite ribbon cable. This prevents the remote start system from activating if the key is left in the "run" position. If your remote start system only has one tan input, you must use diodes to isolate the ignition circuit from the brake switch input. However, due to future manufacturer changes in vehicles, it is possible that this may not apply to all vehicles. In addition, color variations are possible from model to model; make sure to test the circuit carefully. Please call Directed Electronics Technical Support if you need assistance in making this interface.

IMPORTANT! *Once the interface is complete, attempt to remote start the vehicle with the door closed and the key in the ignition. The vehicle should not start. If it does, recheck the connections.*

Diagram A - General Motors trucks, sport utility vehicles and column shifting passenger vehicles:

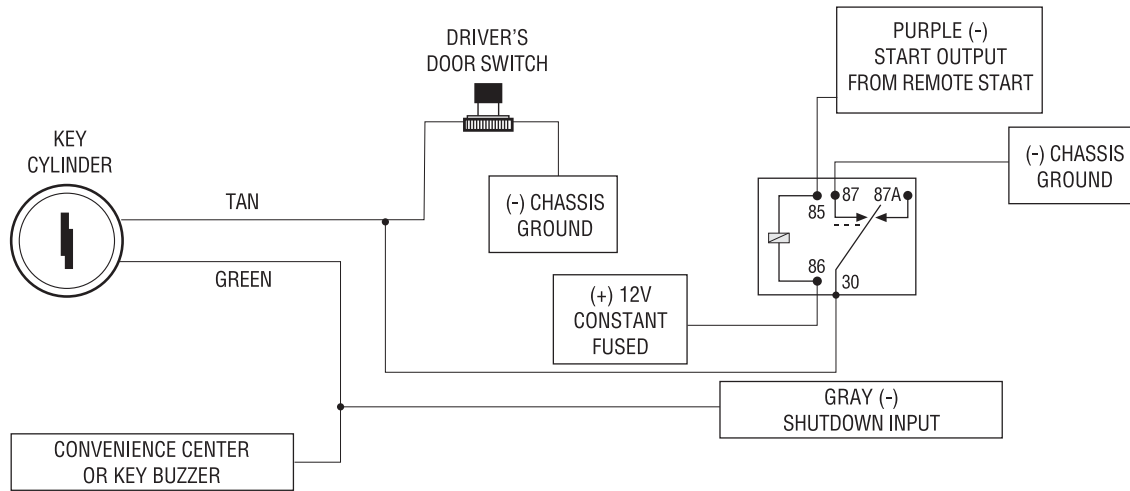
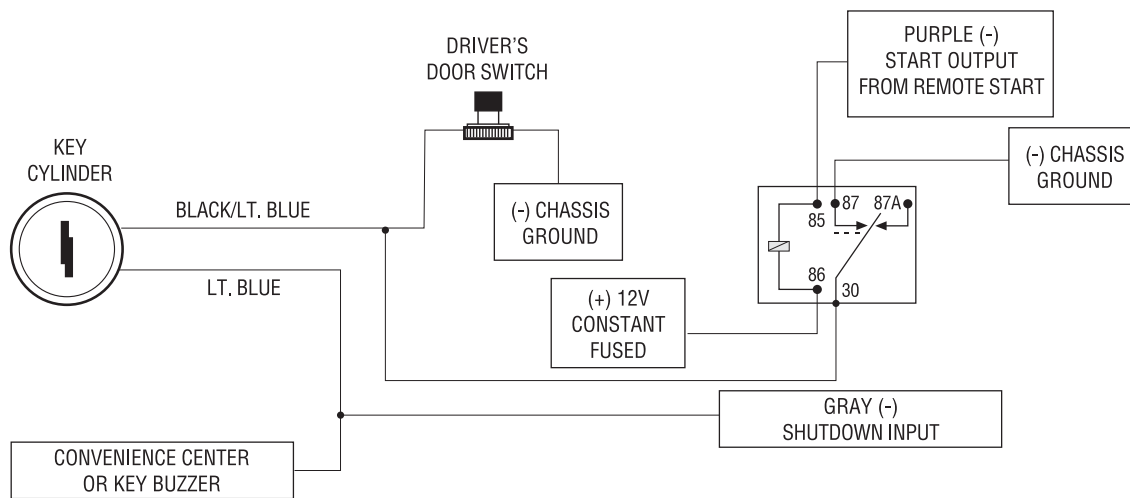

Diagram B - Pre-1996 Dodge Dakota pickups with 2.5 liter motors:



1995 and newer vehicle anti-theft systems (immobilizers)

1995 and newer vehicle anti-theft systems (immobilizers) require a bypass module. The bypass module allows for easy interfacing, while still maintaining the OEM system's integrity.

passlock I and passlock II (PL-1 and PL-2)

The Passlock I and Passlock II systems can be found in the following General Motors vehicles:

- '95 and newer Cavalier and Sunfire
- '96 and newer Achieva, Grand Am, and Skylark
- '97 and newer Intrigue, Malibu, and Cutlass
- '98 and newer trucks, vans, SUVs
- '99 and newer Alero
- 2000 and newer Impala and Saturn

Passlock I and II systems are VATS-evolved. Passlock systems still rely on the R-code to start, but the pellet is no longer placed in the key. The resistor can now be found in the key switch. This allows for a greater number of possible R-codes. In addition, Passlock systems require “seeing” the correct R-code at the correct time. To bypass Passlock I and II, **p/n 555L** or **p/n 555T** is required.

passkey III (PK-3), transponder-based systems

The Passkey III system can be found in the following vehicles:

- '97 and newer Park Avenue
- '98 and newer Cadillac
- '99 and newer U vans, Transport, Montana, and Silhouette
- 2000 and newer Grand Prix, Lesabre, Monte Carlo, Lumina, Bonneville
- 2001 and newer Aurora, Aztek and Rendezvous

Other transponder-based systems include: Acura, BMW, Dodge/Chrysler/Jeep, Ford, Honda, Infinity, Mazda, Mercedes, Mitsubishi, Nissan, Toyota, Volkswagon, and Volvo.

PK-3 and the transponder-based systems use a transponder system that locks out the ignition and fuel system. This transponder system is comprised of two parts. The first part, the transceiver, circles the key switch and is activated when the key is placed in the key switch or turned to the run position. Upon activation, the transceiver will excite the transponder, which is located (but not visible) in the head of the ignition key. The key transponder will then send a unique code back to the transceiver for evaluation. If the code matches a valid code of the system, the vehicle will be allowed to start. Most of these transponder-based systems can be bypassed using **p/n 555U**. Some may require additional parts from the vehicle manufacturer. Consult you dealer for the applications. For most Ford PATS transponders, as well as Lexus and Toyotas, **p/n 555F** can be used, except for the following vehicles, which will require **p/n 555U**: '97 and newer Mark VII, and 2000 and newer Taurus/Sable, Contour/Mystique and Focus.

bypassing GM vehicle anti-theft systems (VATS)

Vehicles with the GM VATS (Pass Key) systems have a resistor embedded in the ignition key. If the VATS decoder module does not measure the proper resistance when the vehicle is started, the starter and fuel pump may be disabled for up to ten minutes. An optional "VATS pack" of resistors is available (p/n 652T). One of the resistors in the pack will match the resistor in the key.

The VATS wires will be two very light-gauge wires coming out of the steering column. The colors of the wires vary, but they are often contained in orange tubing - either both will be white wires, or one wire will be purple/white and the other white/black. Determine the value of the resistor in the key. Then follow the diagram below to bypass VATS during remote start operation. If the BLUE status output from the relay satellite has been programmed for factory security re-arm, then use the (H3/5) BLUE/WHITE 2nd status output from the control module to control the relay.

NOTE: When connecting to the VATS wires, it is not important which wire is cut.

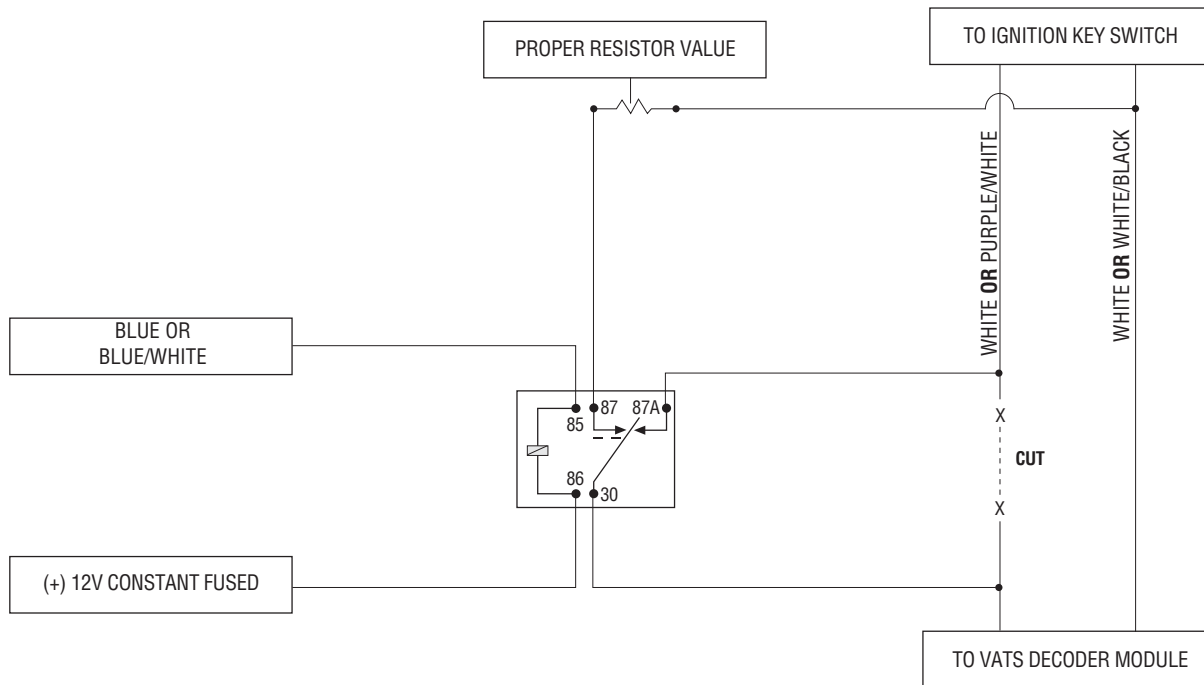

plug-in LED and valet/program switch

These plug into the module. The status LED plugs into the small two-pin socket, while the Valet/Program switch should be plugged into the larger blue two-pin connector. The status LED fits in a $\frac{9}{32}$ -inch hole.

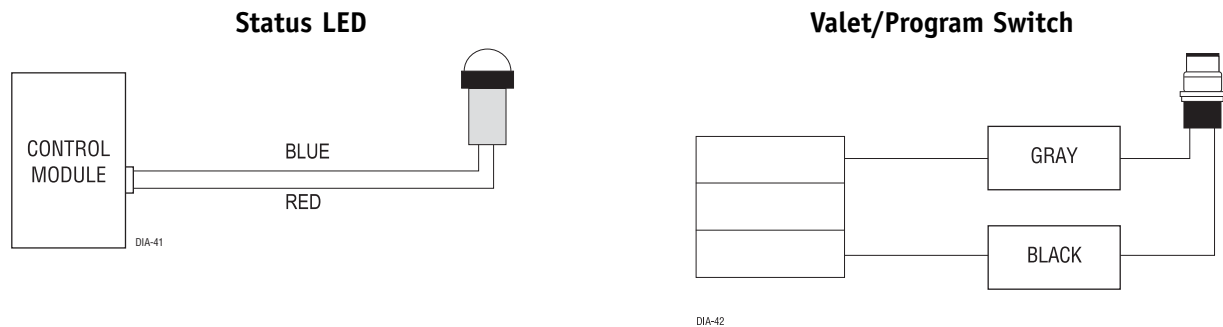

programmer interface, 3-pin port

The black 3-pin port is provided for programming of the unit. The unit can also be programmed using the Bitwriter®. When using the Bitwriter®, it is possible to configure any and all of the programmable functions as well as lock the Transmitter/Receiver and System Features Learn Routines so that unauthorized users cannot change the configuration or program transmitters to the unit.



When the learn routines have previously been programmed using the Bitwriter®, they may have been locked. Before proceeding with reprogramming the learn routines, they must be unlocked with the Bitwriter® - this cannot be done manually with the Valet switch.

programming jumpers

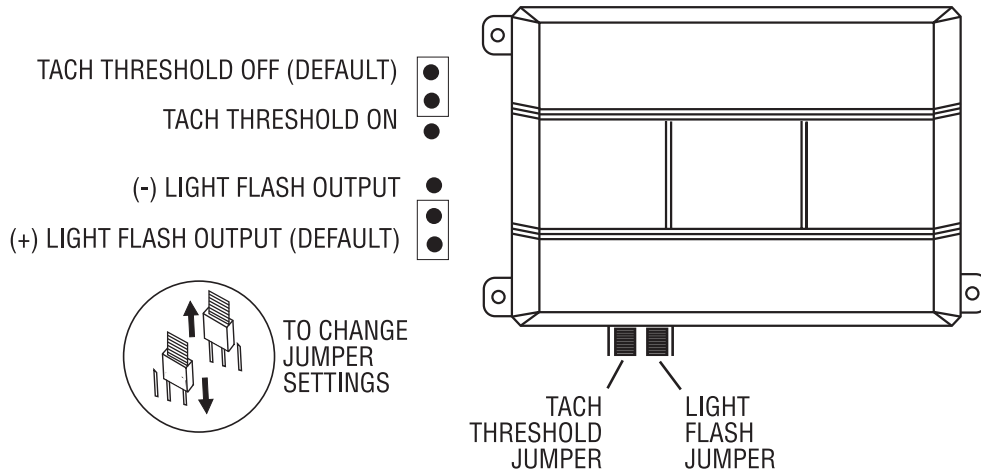

light flash (+)/(-)

This jumper is used to determine the light flash output polarity. In the (+) position, the on-board relay is enabled and the unit will output (+)12V on the WHITE wire, H1/2. In the (-) position, the on-board relay is disabled. The WHITE wire, H1/2, will supply a 200mA (-) output suitable for driving factory parking light relays.

NOTE: For parking light circuits that draw 10 amps or more, the internal jumper must be switched to a (-) light flash output. **P/N 8617** or a standard automotive SPDT relay must be used on the H1/2 light flash output harness wire.

tach threshold on/off

In most cases, this jumper can be left in the OFF position. Some new vehicles use less than 12 volts in their ignition systems. The unit may have trouble learning the tach signal in these vehicles. Changing the jumper to the ON setting changes the trigger threshold of the digital tach circuit so it will work properly with these vehicles. The vehicles affected include many newer Dodge/Chrysler/Plymouth vehicles, such as the Neon, Cirrus, Stratus, Breeze and LH-based vehicles.

transmitter/receiver learn routine

The system comes with transmitters that have been taught to the receiver. The receiver can store up to 4 different transmitter codes in memory. Use the following learn routine to add transmitters to the system or to change button assignments if desired.

The learn routine may be locked if previously programmed using the Bitwriter®. If the horn generates one long honk when attempting to program the unit, the learn routine is locked and must be unlocked using the Bitwriter® before proceeding.

The Valet/Program switch, plugged into the blue port, is used for programming. There is a basic sequence of steps to remember whenever programming this unit: Key, Choose, Transmit and Release.

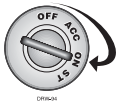

1. **Key.** Turn the ignition to the ON position.



2. **Choose.** Within 10 seconds, press and release the Program switch the number of times corresponding to the desired channel listed below. Once you have selected the channel, press the switch once more and **HOLD** it. The LED will flash and the horn will honk (if connected) to confirm the selected channel. Do not release the Program switch.

CHANNEL NUMBER	FUNCTION	WIRE COLOR
1	Auto Learn*	
2	Arm Panic On/Panic Off	
3	Disarm Panic Off	
4	Silent Mode Channel 2	RED/WHITE
5	Remote Start	
6	Channel 4	VIOLET/BLACK
7	Short Run/Turbo	
8	Timer Mode	
9	Arm/Disarm/Panic	
10	Panic Only	
11	Defogger Control	
12	Delete All Transmitters**	

***NOTE:** For Auto Learn Configurations, see Transmitter Configurations section of this guide.

****NOTE:** If any button from a known transmitter is programmed to Channel 12, all transmitters will be erased from memory and will revert to the default feature settings. This is useful in cases where the customer's transmitters are lost or stolen.



3. **Transmit.** While **HOLDING** the Valet/Program switch, press the button on the transmitter that you would like to control the selected receiver channel. The unit will chirp to confirm that the code has been successfully programmed. It is not possible to teach a transmitter button to the system more than once.



4. **Release.** Once the code is learned, the Valet/Program switch can be released.

You can advance from programming one channel to another by releasing the Valet/Program switch and tapping it to advance channels and then **HOLDING** it. For instance: You have programmed Channel 1 and you want to program Channel 2. Release the Valet/Program switch. Press it one time and release it to advance from Channel 1 to Channel 2. Now, press and **HOLD** the Valet/Program switch. The LED will flash two times and the horn will honk twice (if connected). As before, do not release it.

If you want to program Channel 3 after programming Channel 1, release the Valet/Program switch, press it twice and release it to advance to Channel 3. Then press it once more and **HOLD** it. The horn will honk three times (if connected) and the LED will flash three times to confirm it is ready to receive the code from the transmitter.

Learn Routine will be exited if:

- Ignition is turned off.
- Program switch is pressed too many times.
- More than 15 seconds elapses between programming steps.

One long horn honk indicates that Learn Routine has been exited.

transmitter configurations

The transmitters can be programmed with the separate or single button arm/disarm configurations by using the Auto-learn functions in the Transmitter/Receiver Learn Routine.

button configuration



controls the **Lock/Panic ON/Panic OFF** function.



controls the **Unlock** function.

AUX

controls **Silent Mode™** and an **Auxiliary Output**.



controls **Remote Start**.



+



controls **Timer** mode.

AUX

+



controls **Turbo/Short Run**.



+

AUX

controls **Channel 4** output.



+



+

AUX

controls **Rear Defogger** on/off

operating settings learn routine



The System Features Learn Routine™ dictates how the unit operates. Due to the number of features, the features have been divided into two menus. It is possible to access and change any of the feature settings using the Valet/Program switch. However, this process can be greatly simplified by using the Bitwriter®. Any of the settings can be changed and then assigned to one of up to four transmitters, a feature called Owner Recognition. Each time that particular transmitter is used to disarm the system, the assigned feature settings will be recalled. Owner Recognition is only possible when programming the unit via the Bitwriter®.



The learn routine may be locked if previously programmed using the Bitwriter®. If the horn generates one long honk when attempting to program the unit, the learn routine is locked and must be unlocked using the Bitwriter® before proceeding.

To program the features using the Valet switch:



1. **Key.** Turn the ignition on and then back off.





2. **Select Menu.** Press and **HOLD** the Valet/Program switch. When the LED flashes once and the horn honks Menu One has been selected. Continue to hold the switch until the LED flashes twice and the horn honks twice Menu Two has now been selected. Release the switch after the Menu choice has been selected.



3. **Choose.** Within 10 seconds, press and release the Valet/Program switch the number of times corresponding to the feature number you want to program and then press and hold the switch. (See *Feature Menus*.)

After a second, the LED will flash to indicate which feature you have accessed. For example, in Menu Two, groups of eight flashes would indicate access to the activation pulse setting (Feature 2-8). The horn will also honk eight times (if connected).



4. **Transmit.** The transmitter is used to select the desired setting. Pressing  will change the feature to the LED ON setting (or will flash once for features with more than 2 settings). The horn will honk once (if connected). Pressing  will change the setting to the LED OFF setting (or will flash two or more times for features with more than 2 settings).



5. **Release.** The Valet/Program switch can now be released.

You can advance from feature to feature by pressing and releasing the Valet/Program switch the number of times necessary to get from the feature you just programmed to the feature you wish to access. For example, in Menu One, if you just programmed Feature 1-2 and you next want to program Feature 1-3 to off, release the Valet/Program switch. Press and release it once to advance from Feature 1-2 to Feature 1-3. Then press it once more and **HOLD** it. The LED will flash in groups of 3 and the horn will honk 3 times (if connected) to confirm that you have accessed Feature 1-3.

The learn routine will be exited if:

- The ignition is turned on.
- The Valet/Program switch is pressed too many times.
- More than 15 seconds elapses between programming steps.

One long horn honk (if connected) indicates that the Learn Routine has been exited.

feature menus

Factory default settings are indicated in **bold** in the following feature tables.

menu #1

FEATURE NUMBER	DEFAULT - LED ON SETTING (PRESS CHANNEL 1)	LED OFF SETTING (PRESS CHANNEL 2)
1-1	Active arming	Passive arming
1-2	Chirps ON	Chirps OFF
1-3	Ignition lock ON	Ignition lock OFF
1-4	Ignition unlock ON	Ignition unlock OFF
1-5	Active locking	Passive locking
1-6	Panic with ignition ON	Panic with ignition OFF
1-7	Door Lock pulse duration 0.8 seconds (1)	3.5 (2), 0.4 (3) seconds
1-8	Unlock output 1 pulse	Unlock output 2 pulses
1-9	Lock output 1 pulse	Lock output 2 pulses
1-10	Channel 2 delayed validity	Channel 2 latched (2), latch reset with ignition (3), 30 second timed (4)
1-11	Channel 2 linking None (1)	Arm (2), Disarm (3), Remote Start (4)
1-12	FAD with Channel 2 ON	FAD with Channel 2 OFF
1-13	FAD function with Unlock (1)	Before Unlock (2)/Remote Start only (3)
1-14	FAD 1 pulse	2 pulses
1-15	Security Features ON	Security Features OFF
1-16	Code Hopping ON	Code Hopping OFF
1-17	Channel 4 Validity (1)	Latched (2), Latch reset with ignition (3), 30-sec. timed (4)
1-18	Channel 4 linking None (1)	Arm (2), Disarm (3), Remote Start (4)
1-19	Comfort Closure ON	Comfort Closure OFF

NOTE: The numbers in parentheses indicate the number of times the LED will flash.

menu #2

FEATURE NUMBER	DEFAULT - LED ON SETTING (PRESS CHANNEL 1)	LED OFF SETTING (PRESS CHANNEL 2)
2-1	Engine check ON	Engine check OFF
2-2	Tachometer engine check	Voltage engine check
2-3	12 minutes run time (1)	24 minutes (2), 60 minutes (3) run time
2-4	Flashing parking light output	Constant parking light output
2-5	Cranking time 0.6 sec. (1)*	Cranking time 0.8 (2), 1.0 (3), 1.2 (4), 1.4 (5), 1.6 (6), 1.8 (7), 2.0 (8), 4.0 (9) sec.*
2-6	Voltage check high level	Voltage check low level
2-7	Short run (turbo) 1 minute (1)	3 (2), 5(3), 10 (4) minutes
2-8	Activation pulse: 1 (1)	Activation pulses: 2 (2), 3 (3)
2-9	2nd Ignition output	2nd Accessory output
2-10	Accessory state during wait to start OFF	Accessory state during wait to start ON
2-11	2nd status output NORMAL (1)	Rear defogger latch (2), rear defogger pulse (3)
2-12	Anti-Grind ON	Anti-Grind OFF
2-13	Diesel timer Wait-to-Start input (1)	Timed 15 (2), 30 (3), 45 (4) seconds
2-14	Run Time (Timer Mode) 12 minutes (1)	3 (2), 6 (3), 9 (4) minutes

**NOTE: The numbers in parentheses indicate the number of times the LED will flash.*

feature descriptions

The features of the system are described below. Features that have additional settings that can be selected only when programming with the Bitwriter are indicated by the following icon:

**menu #1**

1-1 ACTIVE/PASSIVE ARMING: When active arming is selected, the system will only arm when the transmitter is used. When set to passive, the system will arm automatically 30 seconds after the last door is closed. To alert the consumer of passive arming, the siren will chirp 20 seconds after the door is closed. This provides the consumer with an audible warning prior to the system actually arming. At the 30 second mark, the system will arm, but the siren will not chirp.

1-2 CHIRPS ON/OFF: This feature controls the chirps that confirm arming and disarming of the system. A siren or horn must be connected to the H1/10 BROWN wire.

1-3 IGNITION LOCK ON/OFF: When turned on, the doors will lock three seconds after the ignition is turned on and unlock when the ignition is turned off.

1-4 IGNITION UNLOCK ON/OFF: When ON this feature will unlock the doors when the ignition is turned off.

1-5 ACTIVE/PASSIVE LOCKING: If passive arming is selected in Menu One, Feature 1-1, then the system can be programmed to either lock the doors when passive arming occurs, or only lock the doors when the system is armed with a transmitter. Active locking means the doors will not lock when the system passively arms. Passive locking means that the doors will lock whenever the system passively arms the optional starter kill (if connected).

1-6 PANIC WITH IGNITION ON/OFF: This feature allows the user to panic the system sounding the siren while the ignition is on.

1-7 DOOR LOCK PULSE DURATION: Some European vehicles, such as Mercedes-Benz and Audi, require longer lock and unlock pulses to operate the vacuum pump. Programming the system to provide 3.5 second pulses, will accommodate the door lock interface in these vehicles. The default setting is 0.8 second door lock pulses. Some modification to the door lock harness (H2) is also necessary. (Refer to *TechTip 1041* for wiring information regarding (+/-) Door Lock Outputs Harness (H4) section, Type E - Mercedes-Benz and Audi -1985 and Newer" diagram.) The 0.4 second pulse is required on some of the newer Chrysler and Ford vehicles.

1-8 UNLOCK OUTPUT—1, 2 PULSES: This will program the unlock output to one or two pulses. When the double pulse unlock feature is turned on, the BLUE H4/1 wire will supply two negative pulses instead of a single pulse. At the same time, the GREEN H4/3 wire will supply two positive pulses instead of a single pulse. This makes it possible to directly interface with double pulse vehicles without any extra parts for unlock and lock outputs (see below).

1-9 LOCK OUTPUT—1, 2 PULSES: This will program the lock output to one or two pulses. When the double pulse lock feature is turned on, the BLUE H4/1 wire will supply two positive pulses instead of a single pulse. At the same time, the GREEN H4/3 wire will supply two negative pulses instead of a single pulse.

1-10 CHANNEL 2 VALIDITY, LATCH, LATCH RESET, 30-SECOND TIMER:

- In the **delayed validity** default setting the Channel 2 output will output a negative (-) signal after the **AUX** button is pressed for more than 1.5 seconds and will continue until the button is released.
- The latched output selection will output a negative signal when the **AUX** button is pressed and will continue until the button is pressed again.
- The **latched/reset with ignition** output selection operates just like the latched output but will reset or stop when the ignition is turned on, then off.
- The **30-second timed** output selection will latch the Channel 2 output on for 30 seconds when the remote

button is pressed or until the button is pressed again within the 30 seconds.

1-11 CHANNEL 2 LINKING (NONE)/ARM, DISARM, BOTH: When programming to validity or timed output this can be programmed to activate when arming or disarming (or both) with the transmitter.

1-12 FACTORY ALARM DISARM (FAD) WITH CHANNEL TWO ON/OFF: Any time Channel 2 is activated from the remote transmitter the factory disarm output will pulse to disarm the vehicle's factory anti-theft device. This option can be programmed off if desired.

1-13 FACTORY ALARM DISARM—WITH UNLOCK, BEFORE UNLOCK, REMOTE START ONLY: In the default setting the factory alarm disarm output will disarm the factory alarm system any time the button(s) controlling Unlock is pressed. The "Before Unlock" output to disarms the factory alarm before the unlock output activates and before remote start is activated. The "Remote Start Only" output disarms the factory alarm only before the remote start is activated.

1-14 FACTORY ALARM DISARM PULSES—SINGLE, DOUBLE: Selectable for a single or double-pulse for the vehicle's factory alarm disarm input requirements.

1-15 SECURITY FEATURES ON/OFF: When On the security features (starter kill and panic) will activate if the ignition key is turned On while the doors are locked. When Off the security features (starter kill and panic) will not activate if the ignition key is turned On while the doors are locked.

1-16 CODE-HOPPING ON/OFF: The system features Code-Hopping as an option. To use Code-Hopping technology, this feature must be programmed On.

1-17 CHANNEL 4 VALIDITY, LATCH, LATCH RESET, 30-SECOND TIMER: This output can be programmed to produce a validity output that will stay active as long as the transmitter button assigned to that channel is pressed, a latched output, a latched output reset with ignition, or a 30-second timed output. (Refer to feature 1-10)

1-18 CHANNEL 4 LINKING (NONE)/ARM, DISARM, REMOTE START: When programming to validity or timed output this can be programmed to activate when arming or disarming (or remote starting) with the transmitter.

1-19 COMFORT CLOSURE—ON, OFF: The system can be programmed to close the windows when the system is armed. A 20-second output starts 200mS after the last lock pulse. The Comfort Closure output will be canceled if the unlock button is pressed. If programmed ON, the lock output wire provides this function.

menu #2

2-1 ENGINE CHECK ON/OFF: In the default setting the remote start will monitor either the vehicle's tach wire or voltage depending on the programming of Feature 2-2. If programmed off, the vehicle will crank for the programmed crank time (Feature 2-5) and will not verify with tach or voltage that the vehicle is running. In the off setting, if the vehicle fails to start, the ignition can stay on for the entire run duration. Using tach or voltage check is always recommended if possible.

2-2 TACH WIRE SENSE/VOLTAGE SENSE: If the tachometer signal wire is used, this feature must be left in the

default (tach wire connected) setting. If programmed to the voltage sense setting, the unit will crank the starter for a preset time that can be programmed in Feature 2-5. Once the starter has been engaged, the system will check the voltage level to verify the engine is running. The threshold for the voltage level test can be programmed in Feature 2-6. When using voltage sense mode, connection of the H3/5 WHITE tachometer input is not necessary.



2-3 RUN TIME 12/24/60 MINUTES: This feature controls how long the engine will run before it “times out” and shuts down. Programmed to the default setting the engine will run for 12 minutes. If the 24-minute run time is desired, change this feature to the on-board LED off setting.

2-4 FLASHING PARKING LIGHT OUTPUT: In the default setting, the unit will flash the vehicle’s parking lights while remote started. The constant setting will turn the parking lights on solidly for the entire run duration.

2-5 CRANKING TIME 0.6/0.8/1.0/1.2/1.4/1.6/1.8/2.0/4.0: If feature 2-2 is programmed to the voltage sense setting, the crank time must be set to the appropriate duration. The default setting is 0.6 seconds. If a different crank time is desired, select feature 2.5 and (while pressing the Valet/Program switch) advance to the next time by pressing the channel 2 button. The unit will flash the LED to indicate which time is selected. Once the 4.0 second setting is reached the next press of channel 2 will reset the system to the shortest setting.

2-6 VOLTAGE CHECK LEVEL HIGH/LOW: This feature only functions when Feature 2-2 is programmed to voltage sense. Some vehicles have many accessories, which are turned on when remote started. In these vehicles, the variation of voltage between the engine off and the vehicle running is very slight and the remote start unit may “think” the vehicle has not started. This can cause the remote start to shut down after the vehicle has been started. If this is the case, program this feature to the LOW position.

2-7 SHORT RUN (TURBO TIMER): When the  and **AUX** buttons on the transmitter are pressed simultaneously, the vehicle will continue to run for the programmed short-run time. The factory default is 1 minute.

2-8 ACTIVATION PULSE COUNT: This feature allows the number of pulses to activate the remote start feature to be changed from 1, 2, or 3 pulses. The pulse count programmed to start the vehicle will also be the same required to shut down the remote start.

2-9 2nd IGNITION/ACCESSORY OUTPUT: This will allow the PINK/WHITE to be used as a 2nd ignition or an accessory.

2-10 ACCESSORY STATE DURING WAIT-TO-START: This will allow the programming of the accessory wire during the wait-to-start period of a diesel motor. When ON the accessory comes on when the wait-to-start output is activated and stays on, dropping out during crank and returning once the car has started. When OFF the accessory will activate as a normal accessory.

2-11 2nd STATUS OUTPUT: This status will activate 10 seconds after the car has started. It is intended to operate the defogger circuit. The output can be programmed to a latched or a pulsed output. When programmed to the latched output the status will only stay active for 10 minutes.

2-12 ANTI-GRIND ON/OFF: With the anti-grind On (default) the ground-when-armed output will be active during remote start operation. If accessories such as a voice module or window module are added to the unit, it may be necessary to program this feature off.



2-13 DIESEL TIMER—WAIT-TO-START/15, 30, 45 SECONDS: Default is the "Wait-to-Start" input control wire, or programmable to ignore the input control wire by a delay of 15, 30, or 45 seconds. This feature can be also programmed with the Bitwriter® and with a delay from 1 to 90 seconds.



2-14 RUN TIME (TIMER MODE)—12, 3, 6, 9 MINUTES: Selects the time in minutes that the system will operate the engine until the system "times out". This is the maximum operation period and the system may be shut down using a shutdown at any time. Using the Bitwriter®, the run time can be programmed for any duration from 1-16 minutes.

tach learning

To learn the tach signal:



1. Start the vehicle with the key.



2. Within 5 seconds, press and **HOLD** the Valet/Program switch.



3. The LED will light constant when the tach signal is learned.



4. Release the Program switch.

shutdown diagnostics

The unit has the ability to report the cause of the last shutdown of the remote start system.

To enter diagnostic mode:



1. Turn the ignition off.



2. Press and **HOLD** the Valet/Program switch.



3. Turn the ignition on and then off.



4. Release the Valet/Program switch.

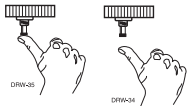

5. Press and release the Valet/Program switch.

The LED will now report the last system shutdown by flashing for one minute in the following grouped patterns:

LED FLASHES	SHUTDOWN MODE
One	System timed out
Two	Over-rev shutdown
Three	Low or no RPM
Four	Transmitter Shutdown (or optional push-button)
Six	(+/-) Shutdown
Seven	(-) Neutral safety shutdown
Eight	Wait-to-start timed out

The LED will stop flashing when the ignition is turned on.

rapid resume logic



The Rapid Resume Logic feature ensures that when the security system is powered back up after power has been disconnected, the system will resume the same state it was in before power was lost. For example, if power is disconnected during a full trigger sequence, the system will still be in the full trigger sequence when power is

reconnected to the unit. If power is disconnected while the unit is disarmed, it will still be disarmed when power is restored.

rear defogger control



The rear defogger output can be remotely turned on/off any time using the remote control. The default setting is **ON**.

To turn the rear defogger output OFF:

1. Press & release the  and  and **AUX** buttons of the remote control.
2. The parking lights will flash 2-times.
3. The rear defogger output will no longer activate when the vehicle is remote started.



NOTE: *If the remote start is On the lights will turn off then flash 2-times before returning to their normal output and the defogger output, if active, will cease.*



To turn the rear defogger output ON:

1. Press & release the  and  and **AUX** buttons of the remote control.
2. The parking lights will flash 3-times.
3. The rear defogger output will once again activate when the vehicle is remote started.

NOTE: *If the remote start is On the lights will turn off then flash 3-times before returning to their normal output and the defogger output will activate as programmed.*

timer mode

By pressing the remote  and  buttons the parking lights will flash 4 times and then start the vehicle and run for the set duration. The remote start can be shut off by the transmitter by pressing the remote start button  and remain in timer mode, but if any other shut down zones or the ignition becomes active the timer mode will cancel.

1. Press Timer mode buttons.
2. The vehicle will confirm with 4 parking light flashes.
3. A 1-second delay will start.
4. The system will start the car and will run for the specified duration, unless shut down by the remote start button . If shut down with the remote start button  the system will remain in timer mode.
5. The system will start every 3 hours until canceled by the brake, hood, or neutral safety shut-down wires.

To exit timer mode, turn the ignition switch on any time the engine is running. The parking lights will flash 4 times, indicating timer mode has been exited.

5. The system will start every 3 hours until canceled by the brake, hood, or neutral safety shut-down wires.

valet mode

To enter or exit Valet Mode with the Valet/Program switch:



1. Turn the ignition on and then off.

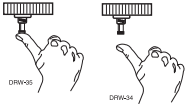

2. Within 10 seconds, press and release the Valet/Program switch.

The status LED will light solid if you have entered Valet Mode, and will go out if you have exited Valet Mode.

safety check

Before vehicle reassembly, the remote system must be checked to ensure safe and trouble-free operation. The following test procedure must be used to verify proper installation and operation of the system. The installation must be completed before testing, including connection to the brake switch and hood switch.

1. Test the BRAKE shutdown circuit: With the vehicle in Park (P), activate the remote start system. Once the engine is running, press the brake pedal. The engine should shut down immediately. If the engine continues to run, check the brake circuit connection.
2. Test the HOOD PIN shutdown circuit: With the vehicle in Park (P), open the hood. Activate the remote start system. The vehicle should not start. If the starter engages, check your hood pin and connections.

NOTE: *If programmed for Diesel Mode, the system will turn on the ignition, but the starter should not engage with the hood open.*

3. Test the NEUTRAL SAFETY shutdown circuit:

IMPORTANT! *Make sure there is adequate clearance to the front and rear of the vehicle before attempting this test.*

- a. Make sure the hood is closed and no other shutdown circuits are active.
- b. Set the emergency brake.
- c. Turn the ignition key to the run position but do not start the engine.
- d. Put the vehicle in Drive (D).
- e. Put your foot over the brake pedal but do not press down on it. Be ready to step on the brake to shut down the remote start system.

- f. Activate the remote start system.
 - If the starter engages, immediately step on the brake to shut down the system. If it does engage, recheck the neutral safety input connection. The vehicle may use a mechanical neutral safety switch. (See H3/5 BLACK/WHITE neutral safety switch input in *Remote Start Harness Wire Connection Guide* section of this guide.)
 - If the starter does not engage, the test is complete.

Once the system passes the three tests, the vehicle can be re-assembled and delivered. Do not use the remote start system or finalize the installation if it fails any of the safety check tests.

troubleshooting

■ The ignition comes on, but the starter will not crank.

Does it start with the key in the ignition? If so, does the vehicle have a VATS Pass-Key system?

Will it start with the brake pedal depressed? (Make sure to disconnect the brake shutdown when performing this test.) If so, it may have a brake/starter interlock.

Is the correct starter wire being energized? Check by energizing it yourself with a fused test lead.

■ The starter cranks for six seconds but does not start.

Either the wrong ignition wire is being energized, the unit's ignition and accessory wires have been connected backwards, or the vehicle has two ignition circuits. Try activating the unit with the ignition key in the "run" position. If the vehicle then runs normally, retest your ignition system.

■ The starter continues to crank even though the engine has started.

Has the tach wire been learned? See *Tach Learning* section of this guide.

Is the tach wire receiving the correct information? Either the wrong tach wire has been used, or a bad connection exists.

■ The climate control system does not work while the unit is operating the vehicle.

Either the wrong accessory wire is being energized or more than one ignition or accessory wire must be energized in order to operate the climate control system.

■ The remote start will not activate.

1. Check harnesses and connections. Make sure the harnesses are fully plugged into the remote start module. Make sure there are good connections to the vehicle wiring.
2. Check voltage and fuses. Use a meter and check for voltage between the red wire in the 5 pin ribbon harness and the black ground wire. If you have less than battery voltage, check both 30A fuses on the relay satel-

lite. Also make sure that the ground wire is going to a chassis ground and not to something under the dash.

3. Check diagnostics. The diagnostics will tell you which shutdown is active or not connected.

■ **The remote start will activate but the starter never engages.**

1. Check for voltage on the purple starter wire two seconds after the remote start becomes active. If there is voltage present, skip to Step 4. If there is not voltage present, advance to Step 2.
2. Check the 30A fuses.
3. Check diagnostics. If the gray/black wire is detecting ground upon activation, the starter will not crank.
4. Make sure the purple starter wire is connected on the starter side of the optional starter kill relay.
5. Does the vehicle have an immobilizer? Some immobilizer systems will not allow the vehicle to crank if active.
6. Check connections. The two red heavy gauge input wires on the relay satellite should have solid connections. "T-taps", or "scotch locks" are not recommended for any high current heavy gauge wiring. Also, if the vehicle has more than one 12-volt input wire, then connect one red wire to each.

■ **The vehicle starts, but immediately dies.**

1. Does the vehicle have an immobilizer? The vehicles immobilizer will cut the fuel and/or spark during unauthorized starting attempts.
2. Is the remote start programmed for voltage sense? If so, the start time may not be set high enough, or you may have to adjust the voltage threshold in programming. Voltage sense will not work on some vehicles.
3. Check diagnostics. Sometimes a shutdown will become active during cranking or just after cranking.

■ **The vehicle starts, but the starter keeps running.**

1. Is the system programmed for engine checking off or voltage sense? When programmed for either of these features, the engine cranks for the preprogrammed crank time regardless of how long it takes to start the vehicle to actually start. Adjust to a lower cranking time.
2. Was the Tach Learn successful? The LED must light solidly and brightly to indicate a successful learn.
3. Make sure that there is a tach signal right at the purple/white tach input wire of the remote start. If not, recheck the connection to the vehicle's tach wire and make sure the wire is not broken or shorted to ground leading to the remote start.

■ **The vehicle will start and run only for about 10 seconds.**

1. Is the remote start programmed for voltage sense? Try programming the unit for low voltage reference. If this does not work, a tach wire should be used.
2. Check diagnostics.

wiring quick reference guide

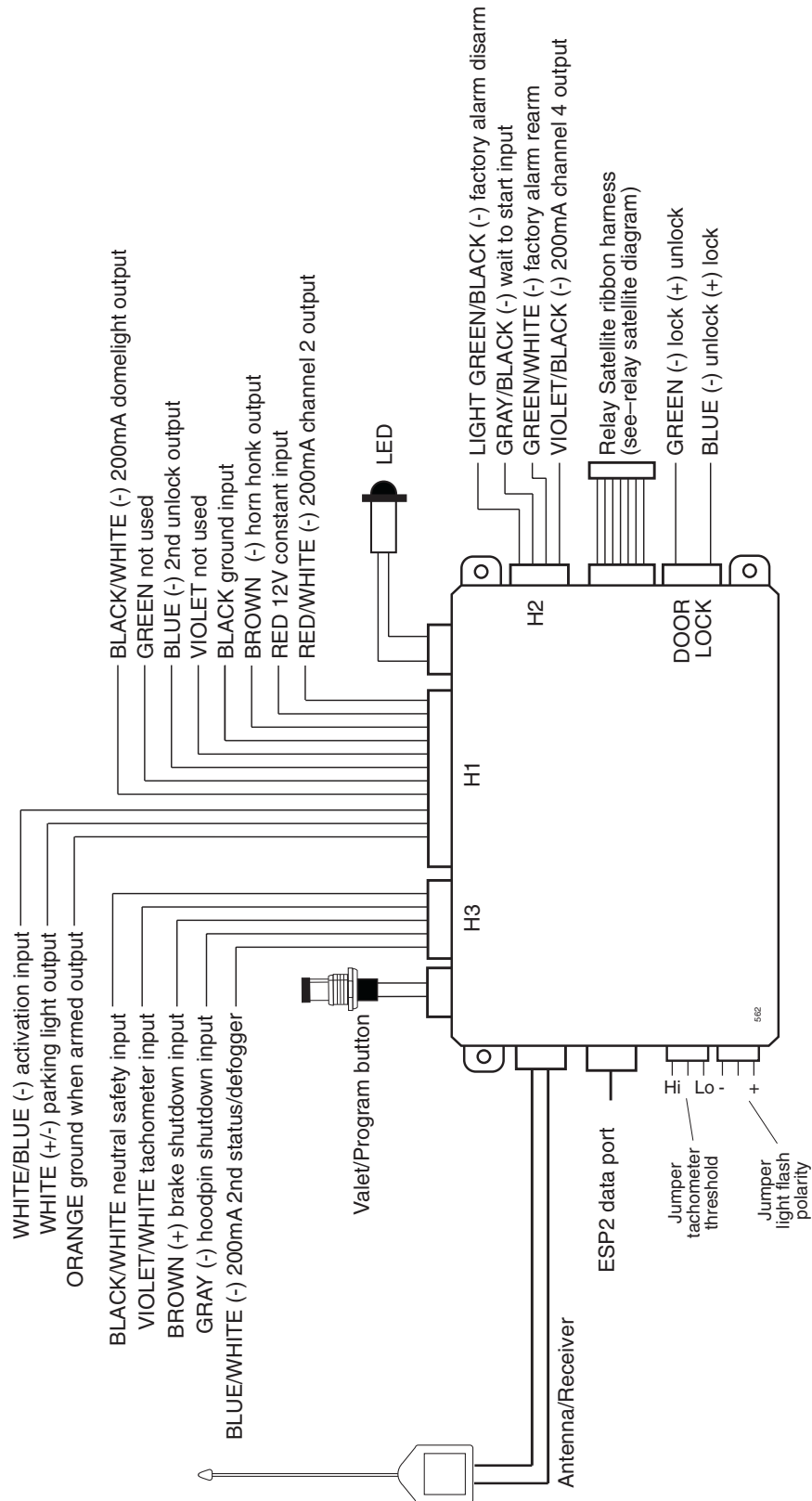

relay satellite wiring quick reference guide

