

AvantGuard 5

installation guide



© 2004 Directed Electronics, Inc. Vista, CA N909640 08-04

***IMPORTANT!** Please note that this manual was intended for US consumers and therefore includes American phrases or words.*

Bitwriter™, Code Hopping™, Directed®, Doubleguard®, ESP™, FailSafe®, Ghost Switch™, Learn Routine™, Nite-Lite®, Nuisance Prevention Circuitry®, NPC®, Revenger®, Silent Mode™, Soft Chirp®, Stinger®, Valet®, Vehicle Recovery System®, VRS®, and Warn Away® are all Trademarks or Registered Trademarks of Directed Electronics, Inc., Vista, California.

contents

warning! safety first	5
before beginning the installation	6
what is included	7
transmitter configurations	7
transmitter functions	8
standard configuration	8
H1 primary harness wire	
connection guide	9
primary harness wiring diagram .9	
primary harness wiring guide . .10	
H2 secondary harness wire	
connection guide	13
secondary harness wiring diagram	13
secondary harness wiring guide	13
immobilizer harness wire	
connection guide	14
immobilizer harness wiring . . .14	
ultrasecure immobilizer15	
immobilizer jumper setting . . .15	
intellistart installation	16
obtaining constant 12V	16
finding the 12V switched ignition wire	16
finding the starter wire	17
finding a (+) brake light wire . .18	
finding the accessory/heater wire	18
finding the rpm input wire . . .18	
How to find a tachometer wire with your multimeter:	19
finding the wait-to-start bulb wire for diesels	19
H3 harness wire	
connection guide	20
harness wiring diagram	20
harness wiring guide	20
H4 heavy gauge harness	
wire connection guide	22
heavy gauge harness wiring diagram	22
heavy gauge harness wiring guide	22
door lock connection guide	24
door lock harness wiring guide .24	
identifying the door lock system	24
at the switch	25
type A: positive-triggered, relay-driven system	25
type B: negative-triggered, relay-driven system	26
type C: reversing polarity system	27
type D: after-market actuators .29	
type E: electronically-activated vacuum systems	30
type F: one-wire system	31
type G: positive (+) multiplex . .32	
type H: negative (-) multiplex . .34	
515C Self-Powered SmartSiren . .36	
siren installation instructions . .36	
peripheral plug-in harnesses . . .37	
super bright blue led, 2-pin white plug	37
plain-view 2 valet	37
mounting the receiver/antenna .38	
arming/disarming diagnostics . . .39	
arming	39
disarming	39
system status chirps	39
remote siren silencing	39
multiple event total recall	40
table of zones	40
system features programming . .41	
cliffnet wizard pro installation software programming	41
manual programming instructions	41

user selectable features	42	one-time valet feature	55
user selectable features		blackjax feature	55
descriptions - column one	43	blackjax activation sequence . .	55
user selectable features		blackjax deactivation sequence	56
descriptions - column two	44	bypass blackjax temporarily	
user selectable features descrip-		(if on in program grid)	56
tions - column three	45	blackjax off warning indicator .	56
installer selectable features . . .	47	sensors	56
installer selectable features		tilt/motion sensor	56
descriptions - column one	48	remote adjustable	
installer selectable features		proximity sensor	58
descriptions - column two	49	remote adjustable omnisensor .	60
installer selectable features		troubleshooting	62
descriptions - column three . . .	50	wiring reference section	63
programming notes	51	control module	
fact II - false alarm control		connector locations	63
technology	53	H1 connector	64
smart power up II	54	H4 connector	67
remote control sensor disable . .	54	H3 connector	67
auto-immobilization feature . .	54	notes	69
auto-immobilization sequence .	54		

warning! safety first

The following safety warnings must be observed at all times:

- Due to the complexity of this system, installation of this product must only be performed by an authorized Clifford dealer.
- When properly installed, this system can start the vehicle via a command signal from the remote control transmitter. Therefore, never operate the system in an area that does not have adequate ventilation. The following precautions are the sole responsibility of the user; however, authorized Clifford dealers should make the following recommendations to all users of this system:
 1. Never operate the system in an enclosed or partially enclosed area without ventilation (such as a garage).
 2. When parking in an enclosed or partially enclosed area or when having the vehicle serviced, the remote start system must be disabled using the installed toggle switch.
 3. It is the user's sole responsibility to properly handle and keep out of reach from children all remote control transmitters to assure that the system does not unintentionally remote start the vehicle.
 4. THE USER MUST INSTALL A CARBON MONOXIDE DETECTOR IN OR ABOUT THE LIVING AREA ADJACENT TO THE VEHICLE. ALL DOORS LEADING FROM ADJACENT LIVING AREAS TO THE ENCLOSED OR PARTIALLY ENCLOSED VEHICLE STORAGE AREA MUST AT ALL TIMES REMAIN CLOSED.
- Use of this product in a manner contrary to its intended mode of operation may result in property damage, personal injury, or death. Except when performing the Safety Check outlined in this installation guide, (1) Never remotely start the vehicle with the vehicle in gear, and (2) Never remotely start the vehicle with the keys in the ignition. The user will be responsible for having the neutral safety feature of the vehicle periodically checked, wherein the vehicle must not remotely start while the car is in gear. This testing should be performed by an authorized Clifford dealer in accordance with the Safety Check outlined in this product installation guide. If the vehicle starts in gear, cease remote start operation immediately and consult with the user to fix the problem immediately.
- After the remote start module has been installed, test the remote start module in accordance with the Safety Check outlined in this installation guide. If the vehicle starts when performing the Neutral Safety Shutdown Circuit test, the remote start unit has not been properly installed. The remote start module must be removed or properly reinstalled so that the vehicle does not start in gear. All installations must be performed by an authorized Clifford dealer.

OPERATION OF THE REMOTE START MODULE IF THE VEHICLE STARTS IN GEAR IS CONTRARY TO ITS INTENDED MODE OF OPERATION. OPERATING THE REMOTE START SYSTEM UNDER THESE CONDITIONS MAY RESULT IN PROPERTY DAMAGE OR PERSONAL INJURY. IMMEDIATELY CEASE THE USE OF THE UNIT AND REPAIR OR DISCONNECT THE INSTALLED REMOTE START MODULE. CLIFFORD WILL NOT BE HELD RESPONSIBLE OR PAY FOR INSTALLATION OR REINSTALLATION COSTS.

before beginning the installation



WARNING! This system is intended for automatic transmission, fuel-injected vehicles only. Installation in a standard transmission vehicle maybe dangerous and is contrary to its intended use.

- Please read this entire installation guide before beginning the installation. The installation of this remote start system requires interfacing with many of the vehicle's systems. Many new vehicles use low-voltage or multiplexed systems that can be damaged by low resistance testing devices, such as test lights and logic probes (computer safe test lights). Test all circuits with a high quality digital multi-meter before making connections.
- Do not disconnect the battery if the vehicle has an anti-theft-coded radio. If equipped with an air bag, avoid disconnecting the battery if possible. Many airbag systems will display a diagnostic code through their warning lights after they lose power. Disconnecting the battery requires this code to be erased, which can require a trip to the dealer.
- Remove the domelight fuse. This prevents accidentally draining the battery.
- Roll down a window to avoid being locked out of the car.

after the installation

- Test all functions. Refer to the "Using Your System" section of the Owner's Guide when testing.
- Complete the vehicle Safety Check outlined in this manual prior to reassembly.

what is included

transmitter configurations

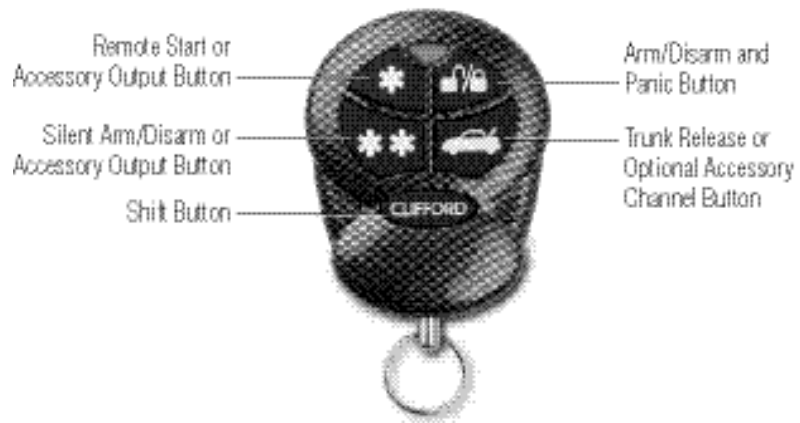

transmitter functions

This system uses computer-based code learning to learn the transmitter buttons. This makes it possible to assign any transmitter button to any system function. The transmitter initially comes programmed with standard configuration, but may also be customized by an authorized dealer. The buttons in all of the instructions in this manual correspond to a standard configuration transmitter.

standard configuration

 Button

The arming, disarming, and panic function are controlled by this button.

 Button



The trunk release or accessory output A is controlled by this button.

 Button



Silent arm and disarm is controlled by this button.

 Button



Remote start is controlled by this button.

 Button, then  Button

Accessory B output is controlled by these buttons.

 Button, then  Button

These buttons activate SmartWindows.

 Button, then  Button

Accessory C output is controlled by these buttons.

 Button twice, then  Button

These buttons active remote valet.

 Button twice, then  Button

These buttons disable the sensors.

 Button twice, then  Button

These buttons enter safe start mode for manual transmission vehicles and activate

Autostart mode.

CLIFFORD Button three times, then ****** Button

These buttons adjust the dual-zone omnisensor.

CLIFFORD Button three times, then ***** Button

These buttons adjust the dual-zone radar sensor.

H1 primary harness wire connection guide

primary harness wiring diagram

H1/1	BLACK	Ground
H1/2	BROWN	Speaker Output 1
H1/3	GRAY	(-) Hood Trigger Input Zone 6
H1/4	EMPTY	Not Used
H1/5	GREEN/WHITE	(-) Normally Closed Input - Zone 6
H1/6	WHITE/BLUE	(-) Accessory B Output (200mA)
H1/7	BLUE	(-) Trunk Trigger Input - Zone 5
H1/8	VIOLET	(+) Door Trigger Input - Zone 4
H1/9	GREEN	(-) Door Trigger Input - Zone 4
H1/10	RED	(+) 12V Constant
H1/11	BROWN	Speaker Output 2
H1/12	WHITE/RED	Light Flash Input
H1/13	WHITE	Light Flash Output
H1/14	WHITE	Light Flash Output
H1/15	BLACK/WHITE	Dome Light Supervision Output 30
H1/16	RED/WHITE	(-) Accessory Output A (200mA)
H1/17	ORANGE	Ground When Armed (500mA)
H1/18	EMPTY	Not Used

primary harness wiring guide

This guide describes in detail the connection of each wire. Also included are possible applications of each wire. This system was designed with the ultimate in flexibility and security in mind. Many of the wires have more than one possible function. Please read the instructions carefully to ensure a thorough understanding of this unit and how it operates.

h1/1 black ground

Connect the BLACK wire to a clean, paint-free sheet metal location (driver's kick panel) using a factory bolt that does NOT have any vehicle component grounds attached to it. A screw should only be used in conjunction with a two-sided lock washer. Under dash brackets and door sheet metal are not acceptable ground points. It is recommended that all security components be grounded at the same location.

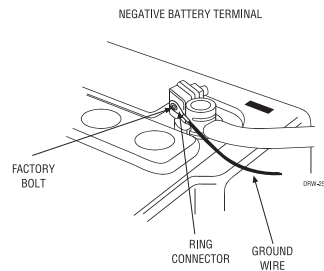
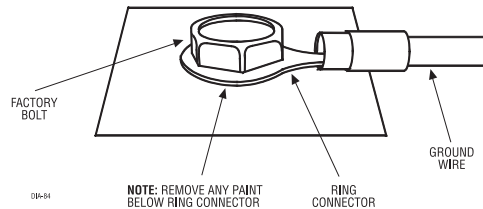

h1/2 and h1/11 brown speaker outputs

Connect the BROWN output wires to the BROWN wires of an optional 518C Neo Siren.

h1/3 gray (-) hood input zone 6

Connect this wire to the hood pin. If the hood is open when the alarm is armed, this wire will trigger the siren. Use either this wire (preferred) or the wire from the Intellistart module, but not both.

h1/5 green/white (-) normally closed zone 6

This wire will trigger the alarm if it loses its normally closed ground. Remove this wire from the ground wire and attach it to a normally grounded item you wish to protect such as the back of your stereo.

h1/6 white/blue (-) accessory b output (200mA)

This wire produces a 200mA output when activated by the remote control and can be used to operate a variety of accessories. All accessory outputs can be programmed to different types of outputs. Please see Programming Note #6.

h1/7 blue (-) trunk trigger input - zone 5

This input will respond to a negative input with an instant trigger. Connect to (-) trunk pins and it will report zone 5. It can also be used with Directed single-stage sensors.

h1/8 violet (+) door trigger input - zone 4

Connect the violet wire to a wire that shows (+)12V when any door is opened. This wire will report Zone 4.

h1/9 green (-) door trigger input - zone 4

Most vehicles use negative door trigger circuits. Connect the GREEN wire to a wire showing ground when any door is opened. When connecting to newer model vehicles there is generally a need to use individual door triggers. This wire will report Zone 4.

NOTE: If using a door trigger wire that has a delay, the installer-selectable programming grid or the Cliffnet Wizard can be used to turn the door ajar warning off.

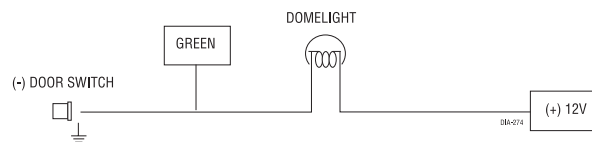

h1/10 red (+) 12v constant

Before connecting the RED wire, remove the supplied fuse. Connect to the battery positive terminal (be sure to use the supplied fuse holder and a 5 amp fuse) or the constant (+) 12V supply to the vehicle fusebox.

h1/12 white/red light flash input

IMPORTANT! Always confirm light flash polarity before connecting Hf1/H12 or damage to the vehicle lighting system could occur.

This wire is the input for the on-board dual light flash relay. If the vehicle has positive parking light activation wires, connect this wire to a constant (+) 12V source that is fused at 15A or higher (be sure to use the supplied fuse holder and a 15 amp fuse). If the vehicle parking light activation wire is negative, connect this wire to a chassis ground location.

h1/13 and h1/14 white parking light output

IMPORTANT! The polarity of this wire is determined by the connection of the H1/12 light flash input wire.

These wires are the output of an on-board dual make relay and the polarity is determined by the connection of the H1/12 light flash input wire. Connect these to the wires in the vehicle that control the parking lights. The dual outputs are designed for European vehicles with isolated parking light systems. If the vehicle's parking lights are controlled by a single wire, connect both WHITE wires to it.

h1/15 black/white dome light supervision output

Connect the H1/15 BLACK/WHITE wire to the vehicle domelight circuit trigger wire.

h1/16 red/white accessory a output

When the system receives the code controlling the accessory output, this wire will supply an output as long as the transmission continues. This is often used to operate a trunk/hatch release or other relay-driven function. All accessory outputs can be programmed to different types of outputs. Please see Programming Note #6.

IMPORTANT! Never use this wire to drive anything but a relay or a low-current input! The transistorized output can only supply 200 mA of current. Connecting directly to a solenoid, motor, or other high-current device will cause it to fail.

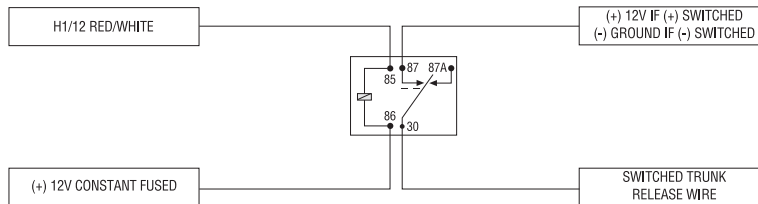

h1/17 orange ground when armed

This wire provides a (-) ground output as long as the system is armed and will cease when the system is disarmed. This output can be used for an additional immobilizer relay or to control additional accessories such as window automation, voice modules, or pagers.

H2 secondary harness wire connection guide

secondary harness wiring diagram

H2/1	WHITE/BLACK	Lock 87A (Normally Closed)
H2/2	GREEN/BLACK	Lock 30 (Common)
H2/3	VIOLET/BLACK	Lock 87 (Normally Open)
H2/4	VIOLET	Unlock 87 (Normally Open)
H2/5	BLUE/BLACK	Unlock 30 (Common)
H2/6	BROWN/BLACK	Unlock 87A (Normally Closed)
H2/7	BLACK/WHITE	Domelight Supervision Input (87)
H2/8	PINK/BLACK	(-) Accessory Output C (200 mA)
H2/9	YELLOW/WHITE	(-) Horn Honk Output (200 mA)
H2/10	BROWN/RED	Brake Light (+) 12V Input
H2/11	BROWN/WHITE	Brake Light Input/Output
H2/12	BLUE/WHITE	Second Unlock Output (200 mA)

secondary harness wiring guide

NOTE: For further description of the H2/1 to H2/12 wires, please refer to the Door Lock Harness Wire Connection Guide section.

h2/7 black/white domelight supervision input (87)

This wire determines the output of the BLACK/WHITE H1/15 wire on the main 18-pin harness. If the vehicle has a negative domelight circuit, ground this wire; if the vehicle has a positive domelight circuit, attach this wire to a 12 volt constant source.

h2/8 pink/black (-) accessory output C (200mA)

This wire produces a 200mA output when activated by the remote control and can be used to operate a variety of accessories. All accessory outputs can be programmed to different types of outputs. Please see Programming Note #6.

h2/9 yellow/white (-) horn honk output (200mA)

This wire is a low current output (200mA) for the horn to sound when the system has been violated.

h2/10 brown/red brake light (+) 12V input

This is the polarity source for the brake light output and must be 12 volt constant.

h2/11 brown/white brake light input/output

This wire powers the brake light circuit with the 12 volt circuit only on H2/10 when activated. If this wire is used it is not necessary to connect the blue/white H1/11 brake input wire to the Intellistart module.

h2/12 blue/white second unlock output (200mA)

This wire produces a (-) 200mA output for progressive locks in which the driver door unlocks first and the remaining locks unlock with a second press of the unlock button.

immobilizer harness wire connection guide

immobilizer harness wiring

Locate the ignition and starter wires using a multimeter. Cut the appropriate wire and attach the key side and car side wires to the corresponding wires on the four-pin immobilizer harness.

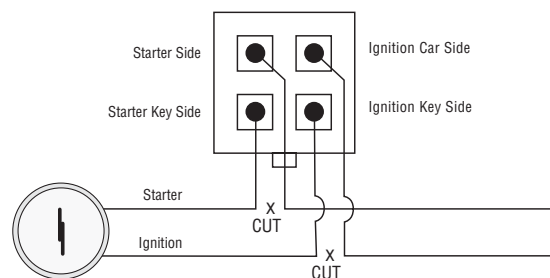

ultrasecure immobilizer

The UltraSecure immobilizer circuit in this G5 system is a unique new design that incorporates the immobilizer security of Clifford without the possibility of failure due to power loss that could potentially strand the user.

The level of security can be set by leaving in or removing the jumper located next to the immobilizer wires exiting the module.

immobilizer jumper setting

jumper in setting

When the jumper is in, the ignition and starter signal will bypass the UltraSecure immobilizer circuitry and allow the vehicle start and run, even if power has not been restored to the module.

jumper out setting

When the jumper is out, the UltraSecure immobilizer circuitry prevents the ignition and starter signal from passing and keeps the vehicle immobilized until power has been restored to the module.

NOTE: In order for the system to bypass the immobilizer with the jumper in place, the unit must have ground on the 18-pin harness.

intellistart installation

***IMPORTANT!** Do not use any testing tool other than a digital multi-meter to prevent costly damage to the vehicle. Use of a test light may cause grounding of sensitive electrical components that can damage the on-board vehicle computer and processors resulting in substantial cost for replacement.*

The control module and the Intellistart module communicate through the CliffNet interface cable, when plugged into their respective ports on each module. Ensure that both modules are mounted in the vehicle so that this cable can reach both modules.

When you have determined where each component will be located, your next step is to find the connecting wires in the vehicle for the security system.

obtaining constant 12V

Remove the two 30 amp fuses prior to connecting to the 12V wires and do not replace them until the intellistart installation is complete. These wires are the source of current for all the circuits the IntelliStart will energize. They must be connected to a high current source. These can be connected to the battery or the 12V power feed to the ignition key switch (the battery is preferred).

finding the 12V switched ignition wire

The ignition wire is powered when the key is in the run or start position. This is because the ignition wire powers the ignition system (spark plugs, coil) as well as the fuel delivery system (fuel pump, fuel injection computer). Accessory wires lose power when the key is in the start position to make more current available to the starter motor.



warning! On vehicles with air bags or supplemental restraint systems (SRS) you may notice a bright yellow tube with small wires in it marked SRS underneath the steering column near the key cylinder. DO NOT tamper or unplug these for any reason to prevent costly damages to your vehicle or personal injury. Tampering may cause unintended deployment of airbags.



warning! Make sure the car is not in gear.

How to find (+)12V ignition with your multimeter:

1. Set to DCV or DC voltage (12V or 20V is fine).
2. Attach the (-) probe of the meter to chassis ground.
3. Probe the wire you suspect of being the ignition wire. The steering column harness or ignition switch harness is an excellent place to find this wire.
4. Turn the ignition key switch to the run position. If your meter reads (+)12V, go to the next step. If it doesn't, probe another wire.
5. Now turn the key to the start position. The meter display should stay steady, not dropping by more than a few tenths of a volt. If it drops close to or all the way to zero, go back to Step 3. If it stays steady at (+)12V, you have found an ignition wire.

finding the starter wire

The starter wire provides 12V directly to the starter or to a relay controlling starter. In some vehicles, it is necessary to power a cold start circuit. A cold start circuit will test exactly like a starter circuit, but it does not control the starter. Instead, the cold start circuit is used to prime the fuel injection system for starting when the vehicle is cold.

How to find the starter wire with your multimeter:

1. Set to DCV or DC voltage (12V or 20V is fine).
2. Attach the (-) probe of the meter to chassis ground.
3. Probe the wire you suspect of being the starter wire. The steering column is an excellent place to find this wire. Remember you do not need to interrupt the starter at the same point you test it. Hiding your optional starter kill relay and connections is always recommended.
4. Turn the ignition key switch to the start position. Make sure the car is not in gear! If your meter reads (+)12V, go to the next step. If it doesn't, probe another wire.
5. Cut the wire you suspect of being the starter wire.
6. Attempt to start the car. If the starter engages, reconnect it and go back to Step 3. If the starter does not turn over, you have the right wire.

finding a (+) brake light wire

Most vehicles use a (+) brake light circuit. The (+) brake light wire is often found near the brake pedal.

How to find a (+) brake light flash wire with your multimeter:

1. Set to DCV or DC voltage (12V or 20V is fine).
2. Attach the (-) probe of the meter to chassis ground.
3. Probe the wire you suspect of being the brake light wire.
4. Press the brake pedal. If your meter shows (+)12V, release the pedal and make sure it goes back to zero.
5. If it does return to zero, this is the correct brake wire.

finding the accessory/heater wire

An accessory/heater wire will show +12V when the key is in the accessory and run positions. It will not show +12V during the cranking cycle. There will often be more than one accessory wire in the ignition harness. The correct accessory wire will power the vehicle's climate control system. Some vehicles may have separate wires for the blower motor and the air conditioning compressor. In such cases, it will be necessary to add a relay to power the second accessory wire.

finding the rpm input wire

To test for a tachometer wire, a multimeter capable of testing AC voltage must be used. The tachometer wire will show between 1V and 6V AC. In multi-coil ignition systems, the system can learn individual coil wires. Individual coil wires in a multi-coil ignition system will register lower amounts of AC voltage. Also, if necessary, the system can use a fuel injector control wire for engine speed sensing. Common locations for a tachometer wire are the ignition coil itself, the back of the gauges, engine computers, and automatic transmission computers.



warning! On vehicles with air bags or supplemental restraint systems (SRS) you may notice a bright yellow tube with small wires in it marked SRS underneath the steering column near the key cylinder. DO NOT tamper or unplug these for any reason to prevent costly damages to your vehicle or personal injury. Tampering may cause unintended deployment of airbags, resulting in injury.

***IMPORTANT!** Do not use any testing tool other than a digital multi-meter to prevent costly damage to the vehicle. Use of a test light may cause grounding of sensitive electrical components that can damage the on-board vehicle computer and processors resulting in substantial cost for replacement.*

How to find a tachometer wire with your multimeter:

1. Set to ACV or AC voltage (12V or 20V is fine).
2. Attach the (-) probe of the meter to chassis ground.
3. Start and run the vehicle.
4. Probe the wire you suspect of being the tachometer wire with the red probe of the meter.
5. If this is the correct wire the meter will read between 1V and 6V and fluctuate with the RPM of the motor.

finding the wait-to-start bulb wire for diesels

In diesel vehicles it is necessary to interface with the wire that turns on the WAIT TO START light in the dashboard. This wire illuminates the bulb until the vehicle's glow plugs are properly heated. When the light goes out the vehicle can be started. This wire is always available at the connector leading to the bulb in the dashboard. It can also be found at the Engine Control Module (ECM) in many vehicles.

To test and determine the polarity of this wire:

1. Set your multimeter to DCV or DC voltage (12 or 20V is fine).
2. Attach the (+) probe of the meter to (+)12V.
3. Probe the wire that you suspect leads to the bulb with the (-) probe of the meter.
4. Turn the ignition switch to the ON position.
5. If the meter indicates 12 volts until the light goes out you have isolated the correct wire and the wire's polarity is negative (ground while the bulb is on).
6. If the meter reads zero volts until the light goes out and then reads 12 volts, you have isolated the correct wire and the wire's polarity is positive.

H3 harness wire connection guide

harness wiring diagram

H3/1	BLACK/GREEN	Automatic Transmission Mode (-)
H3/2	VIOLET/WHITE	Remote Start Smart Lock
H3/3	WHITE/BLACK	Hood Trigger Input (-)
H3/4	WHITE/VIOLET	Factory Alarm Disarm
H3/5	RED	Battery Positive (5-amp fuse) 12V (+) Input
H3/6	BLUE/ORANGE	Third Ignition Trigger (Status Out)
H3/7	BLACK	Ground
H3/8	BLUE/BLACK	Negative Switching Wait-To-Start Bulb (Diesel)
H3/9	BLUE/YELLOW.	Positive Switching Wait-To-Start Bulb (Diesel)
H3/10	BLUE/GREEN	Shut Down (+)
H3/11	BLUE/WHITE	Brake Light Input (+)
H3/12	BLACK/GRAY	RPM Input

harness wiring guide

h3/1 black/green automatic transmission mode



warning! This system is intended for automatic transmission, fuel-injected vehicles only. Installation in a standard transmission vehicle maybe dangerous and is contrary to its intended use.

This wire needs to be grounded when IntelliStart is installed.

h3/2 violet/white remote start smart lock

This wire produces a 200mA negative output when the remote start has been activated locking the doors during the remote start sequence. Connect this to the lock wire of the vehicle, only if the doors must be unlocked to remote start the vehicle.

h3/3 white/black hood input

This wire will shut down the remote start if the hood is opened during a remote start sequence. Connect this to the hood pin switch wire that shows ground when the hood is opened. Use this wire or, preferably, the H1/3 wire from the control module. Do not use both wires (H1/3 and H3/3).

h3/4 white/violet factory alarm disarm

This wire will produce a 200mA output prior to a remote start sequence. Connect this wire to the factory alarm disarm wire in the vehicle.

h3/5 red battery Positive (5-amp fuse) 12V (+) input

Connect this wire to a constant (+) 12V source.

h3/6 blue/orange third ignition trigger (status out)

This wire will trigger an additional relay for a third ignition output. When needed, connect this wire to an optional relay.

h3/7 black ground

h3/8 blue/black (-) and h3/9 (+) blue/yellow diesel wait to start

There are two methods for interfacing the remote engine starting on diesel engines. You can either interface via the "Wait-to-Start" light which will trigger the starter when the light turns off, or you can use the built-in 20 second timer which cranks the engine 20 seconds after the remote start command is received.

Using the 20 second delay: Using the Installer-Programming for the system, change the engine setting to "Diesel Engine," or use the CliffNet Wizard Pro installation software to program the system. The CliffNet Wizard Pro will also allow you to customize the delay to an interval other than 20 seconds.

h3/10 blue/green (+) shut down

1. When the intellistart is programmed to Automatic transmission mode (H3/1 black/green is grounded), then connect the H3/10 blue/green wire to the vehicles back up light wire. This wire should show +12V when the shifter is in reverse, and show no voltage or ground when NOT in reverse.
2. When the intellistart is programmed to Manual transmission mode (H3/1 black/green is NOT grounded) connect the H3/10 blue/green wire to the parking brake indicator wire. The wire should show ground when the parking brake is set, and +12V when the parking brake is NOT set.

h3/11 brake light input (+)

The IntelliStart monitors the brake light to prevent an unauthorized driver from driving the car. The brake light input wire **MUST** be connected and brake light must be in working condition. This connection is not necessary if the alarm is already connected to the brake with the H2/11 wire on the main control module (preferred).

h3/12 black/gray rpm input

This wire monitors the RPM of the vehicle during remote start sequence. Connect this wire to the vehicle coil's negative side or the non-common fuel injector wire.

H4 heavy gauge harness wire connection guide

heavy gauge harness wiring diagram

H4/1	ORANGE	Accessory Output (retained)
H4/2	RED	Battery Positive (30-amp fuse) 12V (+) Input
H4/3	ORANGE/GRAY	Ignition 2 Output
H4/4	GREEN/BLUE	Ignition 1 Output
H4/5	EMPTY	Not Used
H4/6	GRAY/ORANGE	Heater 2 Output (retained)
H4/7	WHITE/BLUE	Starter Output
H4/8	RED	Battery Positive (30-amp fuse) 12V (+) Input
H4/9	GRAY	Heater/Air Conditioner 1 Output (retained)

heavy gauge harness wiring guide

All except the red heavy gauge wires leading from the relay satellite are used to energize high current circuits in the vehicle. It is crucial that these connections are made correctly so that they are capable of handling the current demands. For this reason, scotch locks, T-taps and other such connectors should not be used.

h4/1 orange (+) accessory output (retained)

Connect this wire to the accessory wire in the vehicle that powers the accessories in the vehicle. This wire will retain power for 10 minutes after the ignition key is turned off, or when a door is opened.

h4/2 red (+)12V input

NOTE: If the factory supplies two separate (+) 12V feeds to the ignition switch, connect one RED wire of the intellistart to each feed at the switch.

Remove the 30 amp fuse prior to connecting to the 12V wire and do not replace until the intellistart installation is complete. This wire is the source of current for all the circuits the IntelliStart will energize. It must be connected to a high current source. It can be connected to the battery or the 12V power feed to the ignition key switch (the battery is preferred).

h4/3 orange/gray (+) output to second ignition circuit

Connect this wire to the second ignition wire in the vehicle.

h4/4 green/blue (+) ignition output

Connect this wire to the ignition wire in the vehicle.

h4/6 gray/orange heater 2 output (retained)

Connect this wire to the second accessory wire in the vehicle that powers the climate control system. This wire will retain power for 10 minutes after the ignition key is turned off, or until a door is opened.

h4/7 white/blue (+) starter output

Connect this wire to the starter wire in the vehicle.

h4/8 red (+)12V input

NOTE: If the factory supplies two separate (+) 12V feeds to the ignition switch, connect one RED wire of the satellite to each feed at the switch.

Remove the 30 amp fuse prior to connecting this wire and do not replace them until the satellite has been plugged into the control module. This wire is the source of current for all the circuits the relay satellite will energize. It must be connected to a high current source. Since the factory supplies (+) 12V to the key switch that is used to operate the motor, it is recommended that this wire be connected there.

.h4/9 gray heater/air conditioner 1 output (retained)

Connect this wire to the accessory wire in the vehicle that powers the climate control system. This wire will retain power for 5 minutes after the ignition key is turned off, or until a door is opened.

door lock connection guide

door lock harness wiring guide

h2/1-h2/6 power door locks

The system has door lock relays on-board, and can directly interface with most electric power door lock systems drawing 20 amps or less.

identifying the door lock system

For help in identifying the door lock system, please refer to Directed document 1041.

The easiest way to determine which type of door lock system you are working with is to remove the master locking switch itself, which is usually on the driver's door or on the center console. Once you have determined which type of factory door lock circuit you are working with, and the color codes of the switch wires to be used, you can usually simplify the installation by locating the same wires in the vehicle's kick panel.

NOTE: Always retest the kick panel wires to make sure they work the same as the wires on the master switch.

There are eight different types of common door lock circuits found in vehicles (some vehicles use more unusual systems). The eight most common systems are:

- Type A: Three-wire (+) pulse controlling factory lock relays.
- Type B: Three-wire (-) pulse controlling factory lock relays.
- Type C: Direct-wired reversing-polarity switches. The switches are wired directly to the motors. This type of door lock system has no factory relays.
- Type D: Aftermarket actuator-driven systems. These include slave systems without an actuator in the driver's door but with factory actuators in all the other doors, since these can be controlled with the installation of an aftermarket actuator.
- Type E: Electronically-activated vacuum systems. This requires special programming of the system.
- Type F: One wire system.

- Type G: Positive (+) multiplex resistor-based circuit.
- Type H: Negative (-) multiplex resistor-based circuit.

at the switch

- Three-wire switches will have either a constant ground input or a constant (+)12V input, along with the pulsed lock and unlock outputs to the factory relays.
- Some vehicles have no external switch. The switches are inside the actuator, and instead of pulsing, the proper wires will flip-flop from (+)12V to (-) ground as the door locks are operated.
- Direct-wired switches will have a (+)12V constant input and one or two (-) ground inputs, along with two output leads going directly to the lock motors.

type A: positive-triggered, relay-driven system

IMPORTANT! The H2/1 and H2/6 wires are not required for wiring the door locks. For detailed wiring instructions for these two wires, refer to the beginning of the Door Lock Harness (H2) Wire Connection Guide section. Depending on the type of door lock system, there may be additional H2 harness wires that are not used for wiring the door locks.

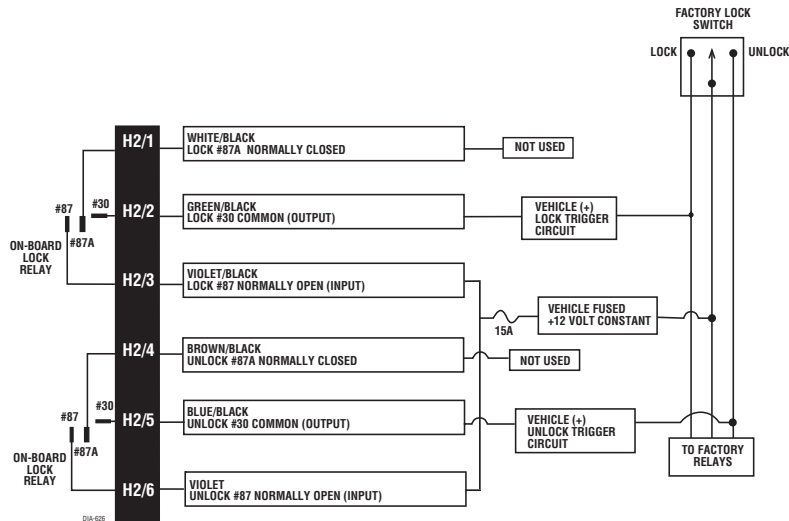

type B: negative-triggered, relay-driven system

IMPORTANT! The H2/1 and H2/6 wires are not required for wiring the door locks. For detailed wiring instructions for these two wires, refer to the beginning of the Door Lock Harness (H2) Wire Connection Guide section. Depending on the type of door lock system, there may be additional H2 harness wires that are not used for wiring the door locks.

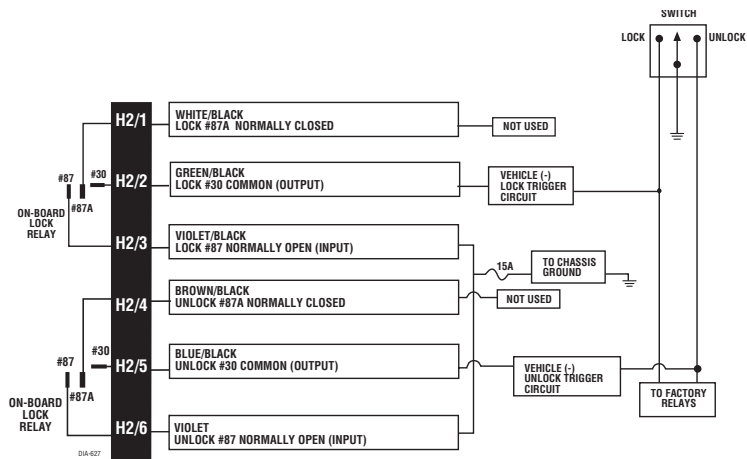

type C: reversing polarity system

Use these instructions if the power door lock switch has four or five heavy-gauge wires. This type of switch has two outputs that rest at (-) ground.

***IMPORTANT!** To interface with these systems, you must cut two switch leads. The relays must duplicate the factory door lock switches' operation. The master switch will have one or two ground inputs, one (+)12V input, and two switch outputs going directly to the slave switch and through to the motors. These outputs rest at (-) ground. The lock or unlock wire is switched to (+)12V, while the other wire is still grounded, thus completing the circuit and powering the motor. This will disconnect the switch from the motor before supplying the motor with (+)12V, avoiding sending (+)12V directly to (-) ground.*

It is critical to identify the proper wires and locate the master switch to interface properly. Locate wires that show voltage when the switch is moved to the lock or unlock position. Cut one of the suspect wires and check operation of the locks from both switches. If one switch loses all operation in both directions then you have cut one of the correct wires and the switch that is entirely dead is the master switch. If both switches still operate in any way and one or more door motors have stopped responding entirely, you have cut a motor lead. Reconnect it and continue to test for another wire. Once both wires have been located and the master switch identified, cut both wires and interface as described in the following paragraphs.

***WARNING!** If these wires are not connected properly, you will send (+)12V directly to (-) ground, possibly damaging the alarm or the factory switch.*

- H2/1 WHITE/BLACK: Once both door lock wires are located and cut, connect the white/black wire to the master switch side of the lock wire. The master switch side will show (+)12V when the master switch is operated to the lock position and (-) ground when the master switch is in the middle position.
- H2/2 GREEN/BLACK: Connect the green/black wire to the motor side of the lock wire.
- H2/3 VIOLET/BLACK: This wire must be connected to a constant (+)12 volts. The best connection point for this wire is the constant (+)12V supply for the door lock switch or directly to the positive (+) battery post with a fuse at the battery post.
- H2/4 VIOLET: This wire must be connected to a constant (+)12 volts. The best connection point for this wire is the constant (+)12V supply for the door lock switch or directly to the positive (+) battery post with a fuse at the battery post.

***NOTE:** Most direct-wired power lock systems require 20-30 amps of current to operate. Connecting the violet/black wire to a poor source of voltage will keep the door locks from operating properly.*

- H2/5 BLUE/BLACK: Connect the blue/black wire to the motor side of the unlock wire.
- H2/6 BROWN/BLACK: Connect the brown/black wire to the master switch side of the unlock wire. The master switch side will show (+)12V when the master switch is in the unlock position and (-) ground when the master switch is in the middle position.

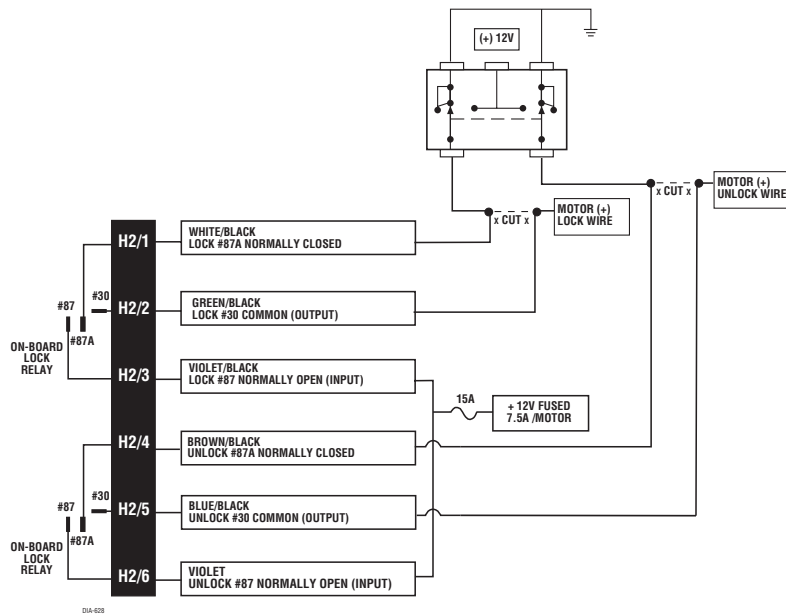

type D: after-market actuators

Vehicles without factory power door locks or with single-point central locking only require the installation of one actuator per door. This requires mounting the door lock actuator inside the door. Other vehicles may only require one actuator installed in the driver's door if all door locks are operated when the driver's lock is used.

The fuse used on 12 volt inputs should be 7.5A per motor installed in the vehicle.

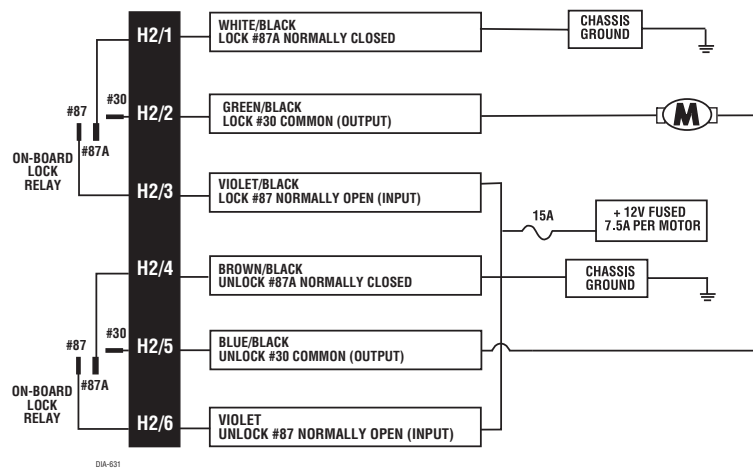

type E: electronically-activated vacuum systems

Type E door locks are controlled by an electrically activated vacuum pump. Test by locking doors from the passenger key cylinder. If all the doors lock, the vehicle's door lock system can be wired as type E. The control wire can be found in either kick panel and will show (+)12 volt when doors are unlocked and (-) ground when doors are locked.

To interface see diagram below. The system must be programmed for 3.5 second door lock pulses up to model year 1993 and 1 second pulse for model year 1994 or newer.

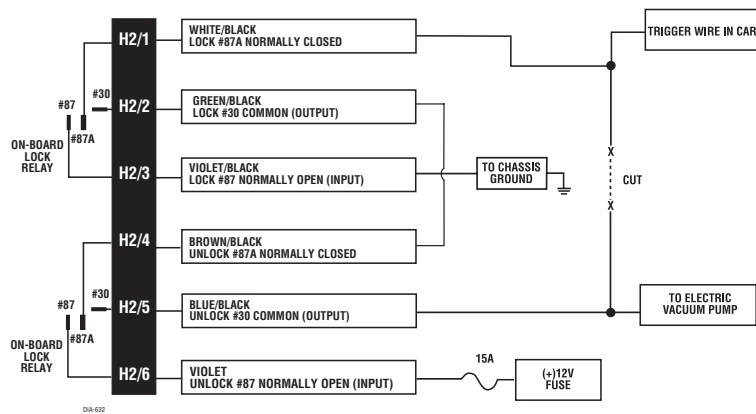

type F: one-wire system

Type F door locks usually require a negative pulse to unlock and cutting the wire to lock the door. In some vehicles, these functions are reversed.

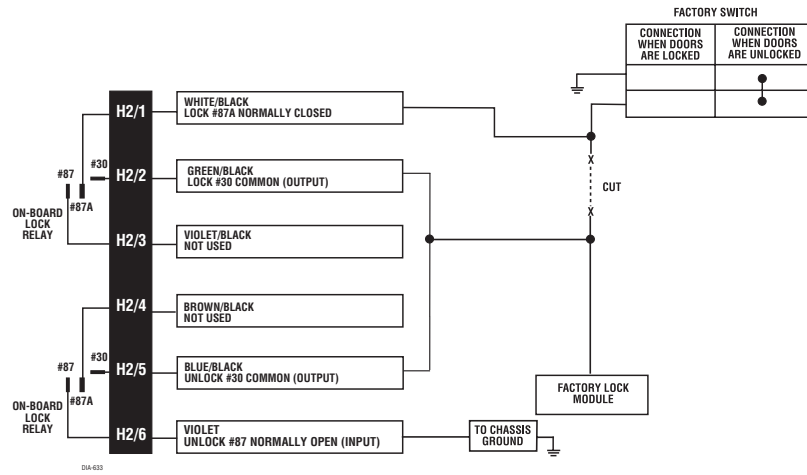

type G: positive (+) multiplex

single-resistor type

If one resistor is used in the door lock switch/key cylinder, the wire will pulse (+)12V in one direction and less than (+)12V when operated in the opposite direction.

two-resistor type

If two resistors are used in the factory door lock switch/key cylinder, the switch/key cylinder will read less than (+)12V in both directions.

determining the proper resistor values

To determine the resistor values, the door lock switch/key cylinder must be isolated from the factory door lock system. For testing, use a calibrated digital multimeter that is set to ohms.

***IMPORTANT!** To ensure an accurate resistance reading, do not touch the resistor or leads during testing.*

1. Cut the output wire from the door lock switch/key cylinder in half.
2. Test with the meter from the switch side of the cut door lock switch/key cylinder wire to a reliable constant (+)12V source. Some good constant (+)12V references are the power input source to the door lock switch/key cylinder, the ignition switch power wire, or the (+) terminal of the battery.
3. Operate the door lock switch/key cylinder in both directions to determine the resistor values. If the multimeter displays zero resistance in one direction, no resistor is needed for that direction.
4. Once the resistor value(s) is determined, refer to the wiring diagram for proper wiring.

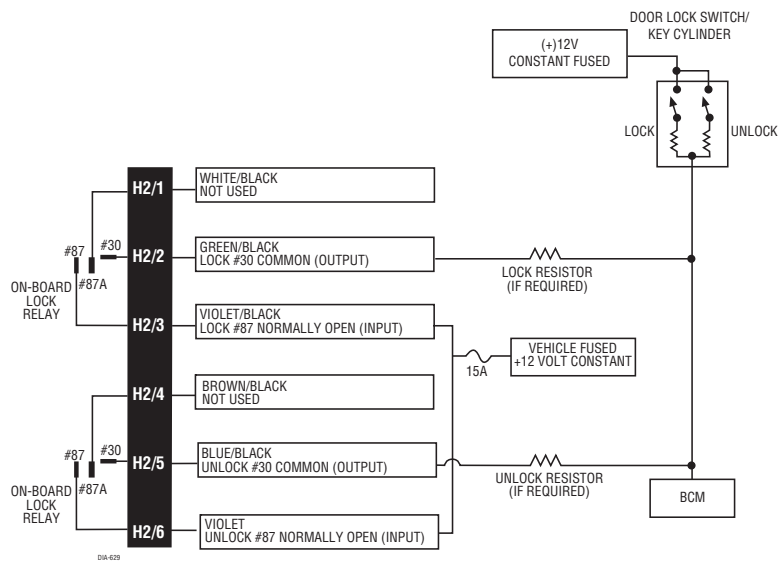

type H: negative (-) multiplex

single-resistor type

If one resistor is used in the door lock switch/key cylinder, the wire will pulse ground in one direction and resistance to ground when operated in the opposite direction.

two-resistor type

If two resistors are used in the factory door lock switch/key cylinder, the door lock switch/key cylinder will read resistance to ground in both directions.

determining the proper resistor values

To determine the resistor values, the door lock switch/key cylinder must be isolated from the factory door lock system. For testing, use a calibrated digital multimeter that is set to ohms.

***IMPORTANT!** To ensure an accurate resistance reading, do not touch the resistor or leads during testing.*

1. Cut the output wire from the door lock switch/key cylinder in half.
2. Test with the meter from the switch side of the cut door lock switch/key cylinder wire to a reliable ground source. Some good ground references are the ground input source to the door lock switch/key cylinder or battery ground.
3. Operate the door lock switch/key cylinder in both directions to determine the resistor values. If the multimeter displays zero resistance in one direction, no resistor is needed for that direction.
4. Once the resistor value(s) is determined, refer to the diagram for proper wiring.

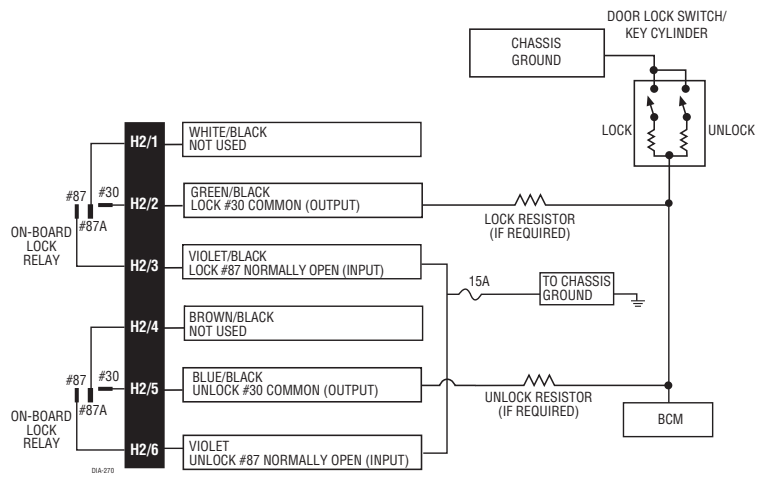

515C Self-Powered SmartSiren

The siren transmits a two-way digital signal between itself and the control unit. If a thief disconnects power and/or cuts or tampers with any or all of the siren wires while the system is armed, the siren will sound for five minutes and then reset. Since this will only occur while the system is armed, there is no need for a siren override key. Unlike other back-up battery sirens that constantly drain the car battery, Clifford's design draws charging current only when the ignition is on (i.e., engine running). If the internal battery is discharged, the arm/disarm chirps are muted.

siren installation instructions

NOTE: Using the CliffordWizard software, you can choose from among 15 different siren sound patterns to customize the siren for distinct recognition.

1. Firmly secure the siren to the engine bay firewall or fender well using all three sheet metal screws supplied. Mount the siren away from areas of water ingress or excessive heat. Point the siren downward to avoid moisture collecting.
2. Run the cable from the 515C Self-Powered Siren through the firewall into the passenger compartment, being careful not to tear the pins from the end of the cable.
3. Insert the siren wires into the siren plug as shown in the diagram below.
4. Insert the 3-pin data harness with the YELLOW and GREEN wires into the CliffNet Wizard port on the control unit.
5. Insert the red two pin power plug into the SSPS (Smart Self Powered Siren) power port.

NOTE: The vehicle must be driven for a total of eight hours after the siren has been installed in order to sufficiently charge the siren's back-up battery.

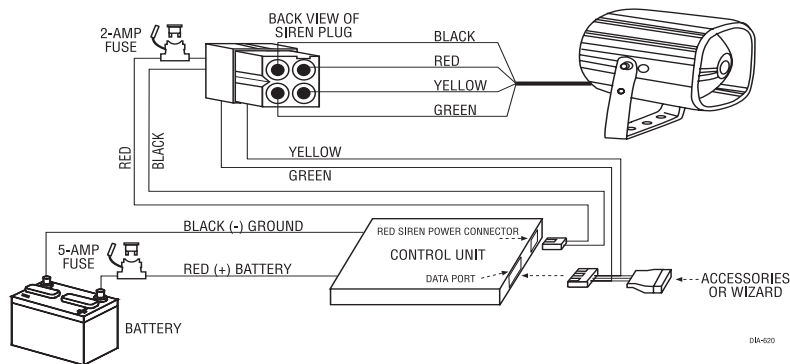

peripheral plug-in harnesses

super bright blue led, 2-pin white plug

The super bright LED operates at (+) 2V DC. Make sure the LED wires are not shorted to ground as the LED will be damaged. Multiple LEDs can be used, but they must be wired in series. The LED can be top-mounted or flush-mounted. If top-loading the LED with a bezel, the LED fits into a 5/16-inch mounting hole. If flush-mounting the LED from the back of a panel, drill a mounting hole using a 17/64-inch drill bit. Be sure to check for clearance prior to drilling the mounting hole.

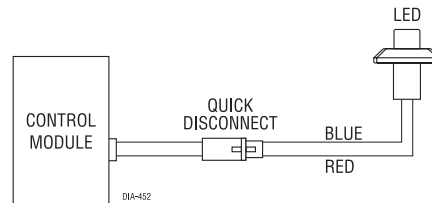

plain-view 2 valet

The Valet/Program switch should be accessible from the driver's seat. It plugs into the blue port on the side of the unit. Consider how the switch will be used before choosing a mounting location. Check for rear clearance before drilling a 9/32-inch hole and mounting the switch.

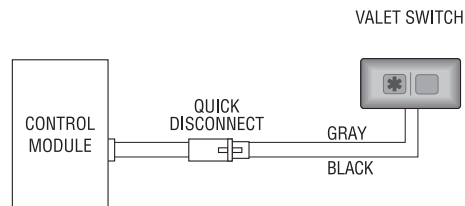

mounting the receiver/antenna

NOTE: Be sure not to bundle or coil excess cable as this will reduce the range.

The receiver/antenna position should be discussed with the vehicle owner prior to installation since the antenna may be visible to the vehicle's operator.

The best position to locate the receiver/antenna is centered high on either the front or rear windshield. For optimal range, the antenna should be mounted vertically. It can be mounted horizontally in relation to the windshield or under the dashboard away from metal, but range will be reduced. Metallic window tint can also affect range, so this should be a consideration when determining the mounting location.

After determining the best mounting location, follow these steps:

1. Clean the mounting area with a quality glass cleaner or alcohol to remove any dirt or residue.
2. Plug the receiver/antenna cable into the receiver/antenna.
3. Mount the receiver/antenna with double-sided tape.
4. Route the receiver/antenna cable down the window pillar to the control module and plug the cable into the control module.

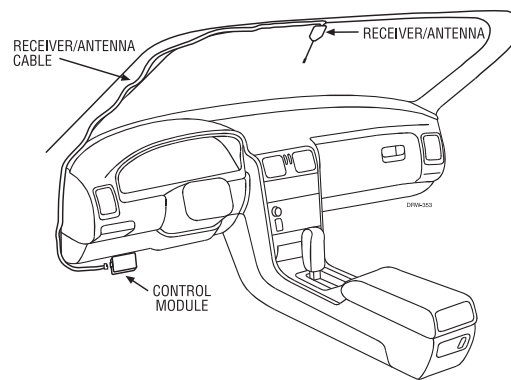

arming/disarming diagnostics

The systems microprocessor monitors and reports all active and violated zones when arming and disarming the system.

arming

Zones that are triggered at the time the system is armed are reported by an additional set of status chirps called *Malfunction AutoBypass*. The specific zone bypassed is then reported by the LED. For more zone information, refer to *Table of Zones* section of this guide.

disarming

If a zone is triggered, three disarm chirps will sound. The specific zone that was triggered is then reported by the LED when the ignition is turned on. For more zone information, refer to the *Table of Zones* section of this guide.

system status chirps

Action	No. of Chirps	Description
Arm	2	System armed.
Arm	4	System armed with hood or trunk bypass zones 5 and 6.
Arm	2 (5-second pause) 4	System armed with door bypass zone 4
Arm	2 (10-second pause) 4	System armed with sensor active and bypassed zones 1, 3, and 8.
Disarm	1	System disarmed.
Disarm	3	System disarmed with zone violation

remote siren silencing

While the siren is sounding, press the arm/disarm button once to silence the siren but leave the system in the armed state. To disarm the system, press the arm/disarm button a second time.

NOTE: If the remote control battery is low, the siren will generate a single low pitched chirp when disarming.

multiple event total recall

This will report the last eight system triggers.



1. Press and hold  of the PlainView 2 Valet switch.
2. While still holding , arm and disarm the system, then release the button.
3. The LED will start to blink to indicate the most recent trigger and proceed down to the eighth trigger. If fewer than eight triggers are stored in memory, the LED will blink continuously until the system is armed/disarmed or the ignition is turned on. For more information, please refer to the Table of Zones section of this guide.

table of zones

When using the diagnostic functions, use the Table of Zones to see which input has triggered the system. It is also helpful in deciding which input to use when connecting optional sensors and switches.

Zone - Number of LED Flashes	Trigger type	Input description
1	Data	Proximity Sensor
2	Data	Omnisensor
3	Mux 1	Sensor Input
4	Instant	Door Pin Input
5	Instant	Trunk Pin Input
6	Instant	Hood Pin Input
7	Instant	Ignition Input
8	Mux 2	Sensor Input
9	N/A	BlackJax Activation
10	N/A	Alarm power reset

system features programming

This system has many features that can be programmed to accommodate the user's personal preferences and make system installation easier. They are listed in two programming grids on the following pages. Many features have default settings that have been programmed at the factory and are indicated in bold type.

The User Selectable Features grid allows the user and installer to change operational features through the PlainView 2 Valet. The Installer Selectable Features grid allows the installer to change input/output functions of the system to integrate with the vehicle's specific characteristics.



cliffnet wizard pro installation software programming

Cliffnet Wizard Pro provides access to all available system features and some that are not available when manually programming with the Valet switch. Cliffnet Wizard Pro is compatible with Microsoft Windows 95/98/2000/ME/XP/NT so most programming operations can be accomplished by pointing and clicking with a mouse. This eliminates the need for programming grids and lengthy programming sequences. For a complete guide to system programming using the Cliffnet Wizard Pro refer to the Cliffnet Wizard help menu.



manual programming instructions

Be sure to document changes by taking note of all feature changes made in programming mode.

To enter the User Selectable Features programming:

1. Ignition on - Turn the ignition to the run position or start the engine.
2. Enter PIN - Enter the factory preset PIN code of 2 by pressing  on the PlainView 2 Valet switch twice, then  once.

NOTE: If the factory preset PIN has been changed, the new PIN must be entered.

3. Hold/Chirp/Release - After entering the PIN code, press and hold  until a chirp is heard and the LED turns on, then release the button. You have now entered the feature selection position of the User Selectable Features grid.
4. Column select - Press  the same number of times as the desired column. After a pause the siren will chirp the same number of times as the selected column for confirmation.
5. Feature select - Press  the same number of times as the desired feature. The siren will chirp with each press. The feature can now be changed using the remote control.













6. Feature change - Press the arm/disarm button on the transmitter. If the system chirps once, the feature has just turned off; if the system chirps twice, the feature has just turned on. If the feature has more than two settings, continue pressing the arm/disarm button on the transmitter to toggle through the settings.

To advance to the next feature in the same column, press  the same number of times as the desired feature within 60 seconds; to change a feature in a different column begin at step 4 by entering the column number first and then the row number.

NOTE: Refer to the Feature Descriptions sections of this guide for important notes and descriptions of the system features and programming.

7. Exit programming - To exit programming mode turn the ignition off or wait 60 seconds without pressing the PlainView 2 Valet switch. The siren will chirp three times to indicate programming mode has been exited.

user selectable features

Then Press \ First Press	1 x 	2 x 	3 x 
1 x 	Add new remote (autolearn)	Set PIN code (default = 2)	New remote learn arm/disarm only
2 x 	Auto (passive) arm off/on	Select siren sounds	New remote learn accessory A channel
3 x 	Chirps off/on/quiet	FACT II off/on	New remote learn accessory B channel
4 x 	Auto lock off/ignition/rpm	Remote valet off/on	New remote learn silent mode
5 x 	Auto unlock off/ignition	Entry delay off/on	New remote learn remote valet
6 x 	Auto (passive) arm and lock off/on	Reset to default (except transmitter and valet code)	New remote learn remote start*
7 x 	Siren duration 30/60/90	Panic off/on	New remote learn window down/vent**
8 x 	Second unlock off/on	Autostart setting* (off/battery only/ temp only/ battery and temp)	New remote learn accessory C channel
9 x 	Not used	BlackJax off/on	Clear all remotes

* This feature is only available with IntelliStart connected.

** This feature is only available with optional SmartWindows connected.

user selectable features descriptions - column one

add new remote (only applicable with Radar 2 remote)

- Auto-learn new remote controls to the system in the standard button configuration. For more information, see programming note #1.

auto (passive) arm - off/on

- Off: The transmitter must be used to arm the system.
- On: When the system sees the ignition turn off and the last protected entry (door, hood, or trunk) close, it will begin a 30-second countdown before arming itself. After the first five seconds, you will hear two chirps and the lights will flash. The system will arm 25 seconds later.

chirps - off/on/quiet

- Off: Chirps will not sound when arming/disarming the system.
- On: Chirps will sound when arming/disarming the system.
- Quiet: Chirps will sound when arming/disarming the system but at a lower volume than normal.

auto lock - off/ignition/rpm

- Off: The doors will not lock automatically.
- Ignition: The doors will automatically lock three seconds after the ignition is turned on unless a door is open at that time.
- Rpm: The doors will lock when the system sees the engine reach a preprogrammed RPM. The H1/4 VIOLET/BLACK or Intellistart must be connected.

auto unlock - off/ignition

- Off: The doors will not automatically unlock when the ignition is turned off.
- Ignition: The doors will automatically unlock as soon as the ignition is turned off.

auto (passive) arm lock - off/on

- Off: The doors will not lock when the system passively arms.
- On: The doors will lock when the system passively arms. This feature only applies when passive arming is programmed on.

siren duration - 30/60/90

- The system will sound the alarm for the programmed duration (30/60/90 seconds) during an alarm trigger or when the system is put into panic mode.

second unlock - off/on

- Off: Second unlock output is pulsed at the same time as the unlock output when the system is disarmed.
- On: Second unlock output is active when the arm/disarm button is pressed within 10 seconds of disarming the system.

user selectable features descriptions - column two

set pin code

- This feature allows the setting of the user's personal PIN code. For more information, see programming note #5. The factory default PIN code is 2.

select siren sounds

- The individual sounds the siren produces during an full trigger alarm can be customized for owner recognition of an alarm trigger. For more information, see programming note #3.

fact II off/on

- Off: The alarm will respond to zone inputs indefinitely without bypassing.
- On: The alarm will bypass for 60 minutes zones that are triggered three times within a one hour period.

remote valet off/on

- Off: The alarm can not be put into valet mode with the remote control.
- On: The alarm can be put into valet mode with the remote control.

entry delay off/on

- Off: There is no entry delay when the system has passively armed. The system will trigger instantly when a door is opened.
- On: If the system has passively armed, it will not trigger for 15 seconds after a door is opened allowing the user to enter the vehicle and disarm the system via the PlainView 2 Valet switch.

reset to default settings

- All system settings (except PIN and remote programming) in the User Programming grid will be reset to their default factory setting as indicated in bold lettering.
- Press the arm/disarm button of the TX; the siren will chirp twice as confirmation.

panic off/on

- Off: The panic feature is not available.
- On: The panic feature is available.

auto start setting - off/battery only/temp only/battery and temp

- This feature is only available with the IntelliStart option.
- Off: The vehicle will not autostart.
- Battery: The vehicle will only autostart when the car battery gets low.
- Temperature: The vehicle will only autostart at a preset low temperature.
- Battery and temperature: The vehicle will autostart with a low car battery or low temperature.

NOTE: Temperature and battery calibration and settings can be made only with the Cliffnet Wizard.

blackjax off/on

- Off: The system cannot enter BlackJax mode.
- On: The system will enter BlackJax mode when triggered.

user selectable features descriptions - column three

The features in this column pertain to programming individual transmitter channels in custom configurations. Following is an explanation of the features. Program the individual transmitter channels following the instructions in programming note #2.

arm/disarm only

- The remote control channel programmed into this feature will arm/disarm the system only.

NOTE: When programming a new remote control to custom configuration a channel must first be programmed to this feature before programming the remaining channels.

accessory a output

- The transmitter channel programmed into this feature will activate the accessory output.

accessory b output

- The transmitter channel programmed into this feature will activate the accessory output.

silent mode

- The transmitter channel programmed into this feature will arm/disarm the system, but the siren will not chirp.

remote valet

- The transmitter channel programmed into this feature will make the system enter/exit valet mode.

remote start

- This feature is only available with IntelliStart connected
- The transmitter channel programmed into this feature will activate or shut down the Intellistart remote start system.

window control

- This feature is only available with SmartWindows connected.
- The transmitter channel programmed into this feature will activate the vent or roll down feature of the SmartWindows system.

accessory c output

- The transmitter channel programmed into this feature will activate the accessory output.









clear all remotes

- This feature will erase all remote codes from the system memory. This feature is convenient for erasing any transmitters that have been lost, stolen, or incorrectly programmed into the system.
- After entering this feature press any button on the transmitter; the siren will chirp to indicate that all transmitters have been erased from memory.

installer selectable features

To enter the Installer Selectable Features grid follow the instructions for the User Selectable Features with the exception of step 4. Perform step 4 as described below to enter the Installer Selectable Features grid.

Hold/Chirp/Release - After entering the PIN code, press and hold  until the siren chirps once. Continue holding for approximately 10 seconds until the siren chirps three times, then release the button. You have now entered the feature selection position of the Installer Selectable Features grid.

Then Press \ First Press	1 x 	2 x 	3 x 
1 x 	Lock pulse single /double	Acc. output A P1 */ P2**/timer A/latch/ latch (ignition reset)	Program RPM
2 x 	Unlock pulse single /double	Acc. output B P1 */ P2**/timer B/latch/ latch (ignition reset)	Engine type petrol /diesel***
3 x 	Lock pulse duration 0.8 /3.5 sec	One time valet off /on	Program SmartWindows 4****
4 x 	Delay domelight off /on	Timer A duration for acc output A	Horn output pulsed /latched
5 x 	Acc. output C auto-activate off /arm/disarm/both	Timer B duration for acc output B	Auto immobilization off /on
6 x 	Acc. output C P1 */ P2**/timer C/latch/ latch (ignition reset)	Timer C duration for acc output C	Not used

- * P1 = Pulsed channel output is disabled with the ignition on or the alarm is armed.
- ** P2 = Pulsed channel output works anytime.
- *** Only with optional IntelliStart connected.
- **** Only with optional SmartWindows connected.

installer selectable features descriptions - column one

lock pulse single/double

- Single: One door lock pulse will be output when the system arms.
- Double: Two door lock pulses will be output when the system arms.

unlock pulse single/double

- Single: One door unlock pulse will be output when the system disarms.
- Double: Two door unlock pulses will be output when the system disarms.

lock pulse duration 0.8/3.5 sec

- 0.8 seconds: The door lock pulses will be 800 milliseconds in length.
- 3.5 seconds: The door lock pulses will be 3.5 seconds in length.

delay domelight off/on

- Off: Smart auto testing will generate a warning to indicate the door is open.
- On: Smart auto testing will ignore the domelight until it goes off.

accessory output c auto activation

NOTE: The accessory output will not auto-activate if programmed to latched setting.

- Off.
- Arm: The accessory output will auto-activate when the system is armed.
- Disarm: The accessory output will auto-activate when the system is disarmed.
- Both: The accessory output will auto-activate when the system is armed and disarmed.

accessory output c programming

The auxiliary accessory output wire (PINK/BLACK) can be programmed for several different types of outputs.

- P1 0.8 seconds: The pulsed output is disabled with the ignition on or the alarm armed.
- P2 0.8 seconds: The pulsed output will operate any time.
- Timed: The length of output duration set.
- Latched: The output on/off controlled by button(s) controlling accessory.
- Latched (ignition reset): The output on/off controlled by button(s) controlling accessory if on, will turn off when the ignition is turned on.

installer selectable features descriptions - column two

accessory output a programming

The auxiliary accessory output wire (RED/WHITE) can be programmed for several different types of outputs.

- P1 0.8 seconds: The pulsed output is disabled with the ignition on or the alarm armed.
- P2 0.8 seconds: The pulsed output will operate any time.
- Timed: The length of output duration set.
- Latched: The output on/off controlled by button(s) controlling accessory.
- Latched (ignition reset): The output on/off controlled by button(s) controlling accessory if on, will turn off when the ignition is turned on.

accessory output b programming

The auxiliary accessory output wire (WHITE/BLUE) can be programmed for several different types of outputs.

- P1 0.8 seconds: The pulsed output is disabled with the ignition on or the alarm armed.
- P2 0.8 seconds: The pulsed output will operate any time.
- Timed: The length of output duration set.
- Latched: The output on/off controlled by button(s) controlling accessory.
- Latched (ignition reset): The output on/off controlled by button(s) controlling accessory if on, will turn off when the ignition is turned on.

one time valet - off/on

- Off: Does not allow one time valet mode feature.
- On: Allows one time valet mode feature.

accessory output a timer duration

- Start Timer: Press the arm/disarm button; the siren will chirp to signal the start of the timer duration setting.
- Stop Timer: Press the arm/disarm button; the siren will chirp to signal the end of the timer duration setting, or for maximum time, do not press the arm/disarm button.

NOTE: The timer max setting is 255 seconds.

accessory output b timer duration

- Start Timer: Press the arm/disarm button; the siren will chirp to signal the start of the timer duration setting.
- Stop Timer: Press the arm/disarm button; the siren will chirp to signal the end of the timer duration setting, or for maximum time, do not press the arm/disarm button.

NOTE: The timer max setting is 255 seconds.

accessory output c timer duration

- Start Timer: Press the arm/disarm button; the siren will chirp to signal the start of the timer duration setting.
- Stop Timer: Press the arm/disarm button; the siren will chirp to signal the end of the timer duration setting, or for maximum time, do not press the arm/disarm button.

NOTE: The timer max setting is 255 seconds.

installer selectable features descriptions - column three

rpm programming

- Programs the tachometer input for the BlackJax and door locks. For more information, see programming note #4.

engine type petrol/diesel

- This feature applies only if IntelliStart 4 is installed.
- Petrol: The IntelliStart will crank the engine three seconds after the ignition is turned on or after input on the wait-to-start wires ceases.
- Diesel: The IntelliStart will crank the engine 20 seconds after it turns the ignition on and will ignore the wait-to-start input wires.

NOTE: RPM must be reprogrammed after changing this feature.

smart windows program

- This feature applies only if SmartWindows is installed.
- Enter this feature and then follow the programming instructions included with SmartWindows.

horn output - pulsed/latched

- Pulsed: H2/9 YELLOW/WHITE wire will generate a pulsing (-) output when the alarm is in full trigger. When arming and disarming the output does not operate.
- Latched: H2/9 YELLOW/WHITE wire will generate a constant (-) output when the alarm is in full trigger. When arming and disarming the output will pulse as per the standard chirp pulses.

auto immobilization - off/on

- Off: Turns the auto immobilization feature off.
- On: Turns the auto immobilization feature on.

programming notes

Note #1: Adding a new transmitter in auto-learn configuration.

- Press the arm/disarm button of the Radar 2 remote control; the siren will chirp once.
- Immediately press arm/disarm again; the siren will chirp twice to confirm the new transmitter has been programmed.



Note #2: Adding a new transmitter in custom-configuration.

- For the arm/disarm channel, transmit the channel of the new three, four, or five button transmitter that you want to control that feature; the siren will then chirp once.
- Immediately transmit the same channel again, the siren will chirp twice to confirm the transmitter channel has been programmed.
- For the rest of the channels only one press of the button is required to learn, and the siren will chirp the same number of times as the feature row.

NOTE: When programming a new transmitter to custom configuration, an arm/disarm channel must first be programmed before programming the remaining channels.

Note #3: Selecting siren sounds.

After entering this feature, press the arm/disarm button. The siren will generate a five-second sample of each available siren sound. Perform the following steps to add or delete that specific sound.

- Add sound: Press  on the PlainView 2 Valet switch while playing the desired sound to add that sound.
- Delete sound: Press  on the PlainView 2 Valet switch while playing the desired sound to delete that sound.

Note #4: RPM programming.

- Drive the vehicle to an open area and allow the engine to warm up until the engine RPM drops to normal idle speed.
- Place the engine in park or neutral and set the parking brake.
- Enter the feature and press the arm/disarm button.
- The lights will flash twice to confirm the engine RPM has been learned.











NOTE: If only one flash is seen, the engine RPM was not successfully learned. Test the tach wire connection and retry.

- Turn the ignition off and activate remote start to test.

Note #5: PIN Programming.

A PIN code can have one to four digits; each digit can be from 0-9.

NOTE: A PIN code cannot begin with a zero.

- Programming Procedure
 1. Enter the feature location in the user-selectable programming grid.
 2. Immediately press and release  of the PlainView 2 Valet switch.
 3. Select each digit by pressing  1-9 times, and then press  to enter the number into the system. To enter a zero, press  only.
- To program a PIN code of 1032:
 1. Press and release  once and  once. You will hear one chirp.
 3. Press and release  once. You will not hear a chirp after programming a zero.
 5. Press and release  three times, and then press  once. You will hear three chirps.
 6. Press and release  two times, and then press  once. You will hear two chirps.
 4. Wait for two siren chirps after a five second pause or five seconds after the last digit has been entered if using less than four digit code number.
 5. Turn off the ignition; the siren will chirp three times.
 6. The programming mode is now exited.

- PIN Code Confirmation Procedure

Begin this procedure within 15 seconds of finishing the programming sequence or the new code will not be set.

1. Turn on the ignition.
2. Enter the new PIN code.
3. Press and hold  for three seconds.
 - LED turns on: New PIN code is learned and programming is complete.
 - LED stays off: New PIN code is not learned and the system reverts to the old PIN code. Repeat the programming sequence.

Note #6: Accessory Channels

- All accessory channels can be programmed to different types of outputs including a pulsed output defeated when ignition is on or the system is armed, a pulsed output regardless of the ignition/armed state, a timed output, a latched output, or a latched output that resets with ignition on.
- Accessory channel C can be programmed to auto-activate with the arm command of the transmitter, the disarm command of the transmitter, or both. Auto-activate can also be turned off and activate as a normal addition accessory channel output.

fact II - false alarm control technology

FACT II will bypass an input zone for 60 minutes if the system sees the same zone triggered three times within one hour, the system will bypass that input for 60 minutes. If that zone does not attempt to trigger the system during the 60 minute bypass period, the system will begin to monitor the zone again at the end of the hour. If it does attempt to trigger while bypassed the 60 minute time period starts over. FACT II will also bypass warn away triggers for the 60 minute duration.

FACT II requires that you change the way you test the system once you have it installed. Resetting FACT II requires the 60 minute time period expiring without attempted triggers or the ignition to be turned on and off. This allows the system to be repeatedly triggered, disarmed and rearmed, and still allow FACT II to bypass a faulty zone.

NOTE: Remember to reset with the ignition when testing sensors.

smart power up II

The Smart Power Up II feature ensures that when the security system is powered back up after being disconnected, the system will resume the same state it was in before power was lost. For example, if power is disconnected during a full trigger sequence, the system will still be in the full trigger sequence when power is reconnected to the unit. If power is disconnected while the unit is disarmed, it will still be disarmed when power is restored.

remote control sensor disable

1. Arm the system.
2. Use the transmitter to bypass the sensor (Clifford button twice followed by trunk button).
3. The lights will flash four times. All warn away zones are now bypassed.
4. Transmit the sensor bypass channel again.
5. The lights will flash four times again. The sensor warn away and full trigger zones are now bypassed.
6. The sensor zones will reset when disarmed.

auto-immobilization feature

Immobilizer circuits automatically activate after 30 seconds.

NOTE: H1/17 orange ground when armed will not activate during Auto-Immobilization.

auto-immobilization sequence

1. Turn ignition off or disarm alarm.
2. After 30 seconds the systems Immobilization circuits activate and engage the starter and ignition interrupt.
3. LED blinks at 1/2 normal speed.

Disarm the system when immobilized

Use one of the following methods to turn off auto-immobilization.

- Turn ignition on and press the arm/disarm button of the transmitter.
- Arm the alarm and then disarm the alarm.
- Turn the ignition on and enter the system valet/PIN code.

one-time valet feature

This feature allows the system to be put in valet mode only until the next time the ignition is turned off.

ON: Valet mode will be exited every time the ignition is turned on.

OFF: Valet mode will only be exited by using the valet switch or the remote control.

blackjax feature

blackjax activation sequence

When BlackJax is programmed ON, BlackJax sequence will begin every time the ignition is turned on and must be turned off by entering your PIN code. It will then activate again while driving when triggered as described below.

NOTE: BlackJax can be turned off by entering PIN code at any time.

1. Ignition on (engine does not have to be running)
 - System sees input on Zone 7 ignition input.
2. Door Open & Close.
 - System sees input on H1/8 or H1/9 Door trigger input.
3. Press and release brake pedal.
 - a. System sees (+) input on H2/11 BROWN/WHITE brake input/output wire.
 - b. System then begins monitoring input on H1/4 VIOLET/BLACK wire or Intellistart 4.
5. If PIN code is NOT entered within 20 seconds:
 - System sounds siren and begins flashing parking lights.
 - Brake lights continue to flash.
 - The system will now immobilize as described in steps 6-7.
6. If system sees the RPM rate return to 1 ½ times programmed RPM rate or lower, the system will immobilize the vehicle as described in step 7.
7. Vehicle Immobilization:
 - immobilizer will engage the starter and ignition circuits.
 - The siren will continue to sound and the parking and brake lights will flash for a maximum of 5 minutes.
 - Immobilization circuits will remain active until correct PIN code is entered.

blackjax deactivation sequence

To deactivate BlackJax turn the key on and then enter the PIN code at any time.

bypass blackjax temporarily (if on in program grid)

Bypass BlackJax temporarily

1. Turn ignition on.
2. Enter PIN code. Do not enter valet or programming mode.
3. Within 10 seconds: Press lock/unlock button of remote control.
4. Siren chirps 1 time as confirmation of BlackJax bypassed.
5. Turn Ignition Off, siren chirps 3 times as confirmation of exiting programming.

NOTE: If ignition remains on after entering PIN code and no action for 10 seconds, unit will automatically exit programming mode without chirps.

To return to normal BlackJax Operation

1. Turn ignition on.
2. Enter Pin code.
3. Within 10 seconds: Press lock/unlock button of remote control.
4. Siren chirps 2 times as confirmation of BlackJax active.
5. Turn ignition off, siren chirps 3 times as confirmation of exiting programming.

NOTE: If ignition remains on after entering PIN code and no action for 10 seconds, unit will automatically exit programming mode without chirps.

blackjax off warning indicator

Each time the ignition is turned off when BlackJax is bypassed the LED will blink 10 times as a visual reminder.

sensors

tilt/motion sensor

The 507T Tilt/Motion Sensor is used to compliment the level of security provided by the shock sensors found on most alarm systems. The tilt/motion sensor detects when the vehicle is being raised in an attempt to either remove the wheels/tires or tow the vehicle. The 507T is capable of independently learning the vehicle's initial angles of vertical and horizontal inclination each time the vehicle is parked, ensuring the most accurate tilt (vertical) and motion sensing (horizontal) possible.

mounting the tilt/motion sensor

The sensor control module must be mounted at an angle no greater than 45 degrees, with respect to the horizontal plane of the vehicle, and it must be mounted with the case top facing upward. We recommend mounting the control module to the floor of the vehicle. To mount the control module, fasten the unit with either Velcro or screws.

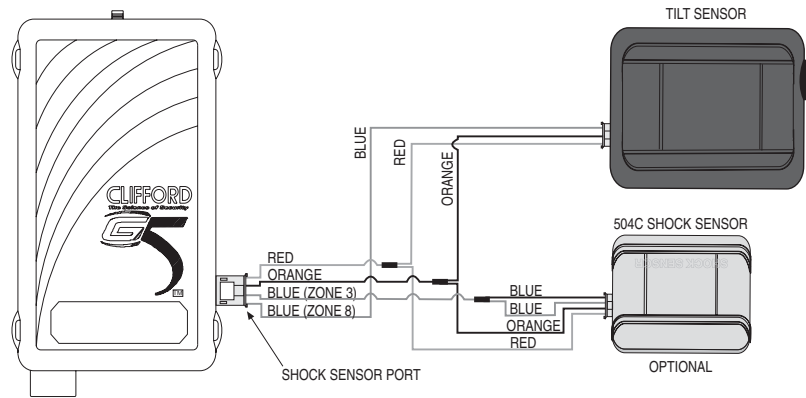

programming the sensor

The unit has selectable dipswitch settings for both the tilt threshold and the motion sensitivity levels. The dipswitches are located on the side of the sensor next to the harness plug. Dipswitch 1 controls the tilt sensitivity threshold, and dipswitches 2 and 3 control the motion sensitivity threshold. Dipswitch 4 will control the arming delay from either 10 seconds or 2 minutes. One second after the unit has powered up, the 507T has an internal LED that will flash in two groups to indicate which sensitivity settings have been programmed. The first group of LED flashes indicates the tilt sensitivity setting, and the second group indicates the motion sensitivity setting.

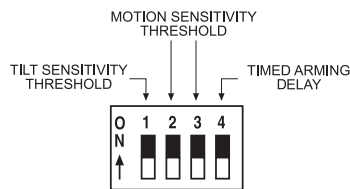

tilt sensitivity threshold

Dipswitch 1 controls the tilt sensitivity threshold that detects when the vehicle is being lifted. A 1-degree threshold (on) can be selected for extreme sensitivity, or a 3-degree threshold (off) can be selected for normal sensitivity.

motion sensitivity threshold

Dipswitches 2 and 3 control the motion sensitivity threshold that detects horizontal vehicle movement, such as when the vehicle is rocked back and forth when using a jack to remove the wheels or tires. The motion sensitivity can be programmed off, or to a low, medium or high sensitivity setting.

Dipswitch 2	Dipswitch 3	Setting
OFF	OFF	Disable motion
OFF	ON	low motion sensitivity
ON	OFF	Medium Sensitivity
ON	ON	High motion sensitivity

arming delay

Dipswitch 4 sets the amount of time the sensor waits before it will become active. In the off position, the sensor will have a 10-second delay; In the on position, the sensor will have a two-minute delay before becoming active.

remote adjustable proximity sensor

The proximity sensor input circuitry has been improved for G5 so the sensor only has power when the alarm is armed. While driving this protects highly sensitive vehicle electronics (i.e. radar detectors) that can be affected by outside interference. However, this does change the way the sensor is adjusted but will not affect normal operation of the sensor.

locating the proximity sensor

Inside the vehicle's headliner is the optimal mounting location for this sensor and should always be the first choice. The sensor should face down, centered side to side, with the wire harness exiting toward the front of the vehicle.





If headliner mounting is not possible, the sensor can be placed in a lower area of the vehicle, but field size and sensitivity may be affected. The armrest of the center console may be appropriate.



NOTE: Never place the sensor behind any metal brackets or under console pockets that will have coins or other metal objects in it.





adjusting the proximity sensor

It is recommended that adjustments be performed away from fluorescent lighting, large metal structures, or confined areas that can affect the sensor field. The proximity sensor field takes about one to two minutes to settle after it receives power. Make the first adjustment with the remote control after about 45 seconds. If the alarm does not see an adjustment signal, it will exit adjustment mode after 60 seconds. Make the adjustments slowly to let the sensor field settle. Each zone has 32 settings that are indicated by chirps that raise and lower in frequency as adjustments are made.

If the alarm exits adjustment mode automatically it will revert to its previous settings. To lock in the new settings, you **MUST** exit using the  button after programming! The total adjustment time for this sensor should be 5 minutes or less. Taking the time to properly adjust this state-of-the-art sensor will give your customer years of unsurpassed security and stop any returns for further adjustments.

1. Disarm system
2. Transmit Channel 16. (Press  3 times then  1 time)
 - The LED will turn on and the siren will chirp 1 time.
 - Primary (full trigger) zone adjustment has now been entered.
 - Primary zone can now be adjusted.
3. To adjust Primary Zone
 - Press  of the remote control to increase sensitivity.
 - Press  of the remote control to decrease sensitivity.
 - The sensor Primary zone can be tested at any time during adjustment and will generate 1 siren chirp each time the zone is activated.
4. Press  to adjust Warn-Away zone
 - Siren chirps 1 time.
 - Warn-away Zone adjustment has now been entered.
 - Warn-away Zone can now be adjusted.

5. To adjust Warn-away Zone
 - Press  to increase sensitivity.
 - Press  to decrease sensitivity.
 - The sensor Warn-away zone can be tested at any time during adjustment and will generate 1 siren chirp each time the zone is activated.

6. Press  of the remote control to return to Primary zone adjustment and lock in Warn Away zone setting.
 - Siren chirps 2 times.
 - Primary zone can now be re-adjusted as described in step 3.
 - Or press  again to lock in primary zone setting and exit programming mode.
 - The siren will chirp 3 times when sensor adjustment mode has been exited.
 - **Auto-scroll for adjusting sensitivity** - press and hold  or  to increase or decrease sensitivity setting several levels rapidly.

remote adjustable omnisensor

The Omnisensor is designed for ease of adjustment by the user and to give the ultimate in impact detection without the possibility of false triggers that are common with less sophisticated sensor.

Installing the omnisensor

The omnisensor can be located in either the passenger or engine compartment. It must be firmly mounted with the indicator arrow pointing UP to a vertical metal surface. For best results it must be secured sheet metal screws using ALL FOUR mounting points.



Adjusting the omnisensor

While adjusting this sensor it is required that you strike the vehicle with the amount force that is desired for the system to trigger.

***CAUTION!** DO NOT strike window glass or flat sheet metal panels that can dent easily. It is recommended that you only strike the metal pillars between the windows, they are structurally sound enough not to dent. ONLY strike the pillars using the heel of your hand, it is more than sufficient for the sensor distinguish as a theft attempt.*



1. Disarm system.
2. Transmit Channel 15 (Press **CLIFFORD** 3 times then   1 time).
 - The LED will turn on and the siren will chirp 1 time.
 - Sensor test and adjustment mode is entered.



3. To test Primary (full trigger) zone.
 - Press  of the remote control.
 - Siren will chirp 2 times.
 - Hit vehicle.
 - Siren chirps 1 time if hit hard enough to activate sensor.

4. To adjust Primary zone.
 - Press  of the remote control.
 - Siren chirps 2 times.
 - Sensor adjustment mode is entered.
 - Hit vehicle at the desired level of impact.
 - Sensor adjusts itself to the force of Hit.
 - Siren chirps 1 time as confirmation of adjustment.
 - Press  of the remote control to lock adjustment.

5. To adjust Warn-away zone.
 - Press .
 - Siren chirps 1 time.
 - Warn-away zone adjustment is entered.

6. To test Warn-away zone.
 - Press .
 - Siren will chirp 2 times.
 - Hit vehicle.
 - Siren chirps 1 time if hit hard enough to activate sensor.

7. To adjust Warn-away zone.
 - Press .
 - Siren chirps 2 times.
 - Sensor adjustment mode is entered.
 - Hit vehicle at the desired level of impact.
 - Sensor adjusts itself to the force of Hit.
 - Siren chirps 1 time as confirmation of adjustment.
 - Press  to lock adjustment.

8. Press  to re-enter Primary zone adjustment.
 - Siren chirps 2 times.
 - Primary zone can now be re-adjusted as described in #4.
 - Or press  again to exit programming mode.
 - The siren will chirp 3 times when sensor adjustment mode has been exited.

Note: You must wait 15 seconds for omnisensor to become active after arming.

troubleshooting

Sensors do not trigger the alarm.

- Has the FACT II system been triggered? To check this, turn the ignition key on and off to clear the FACT II from memory, and then retest the shock sensor. For a detailed description of FACT II, see the *FACT II: False Alarm Control Technology* section of this guide.

Closing the door triggers the system, but opening the door does not.

- Have you correctly identified the type of door switch system? This happens often when the wrong door input has been used.

The system will not passively arm until it is remotely armed and then disarmed.

- Are the door inputs connected? Is a BLUE wire connected to the door trigger wire in the vehicle? The GREEN H1/9 or the VIOLET H1/8 should be used instead.

The PlainView 2 Valet switch does not work.

- Is the quick disconnect plugged in correctly?
- Is it plugged into the correct socket?
- Check the System Features Learn Routine for the default PIN code.
- Has the PIN code been changed?

The status LED does not work.

- Make sure that it is plugged in. (See the *Plug-In Harnesses* section of this guide.) Is the LED plugged into the correct socket?
- Is the quick disconnect plugged in correctly?

wiring reference section

control module connector locations

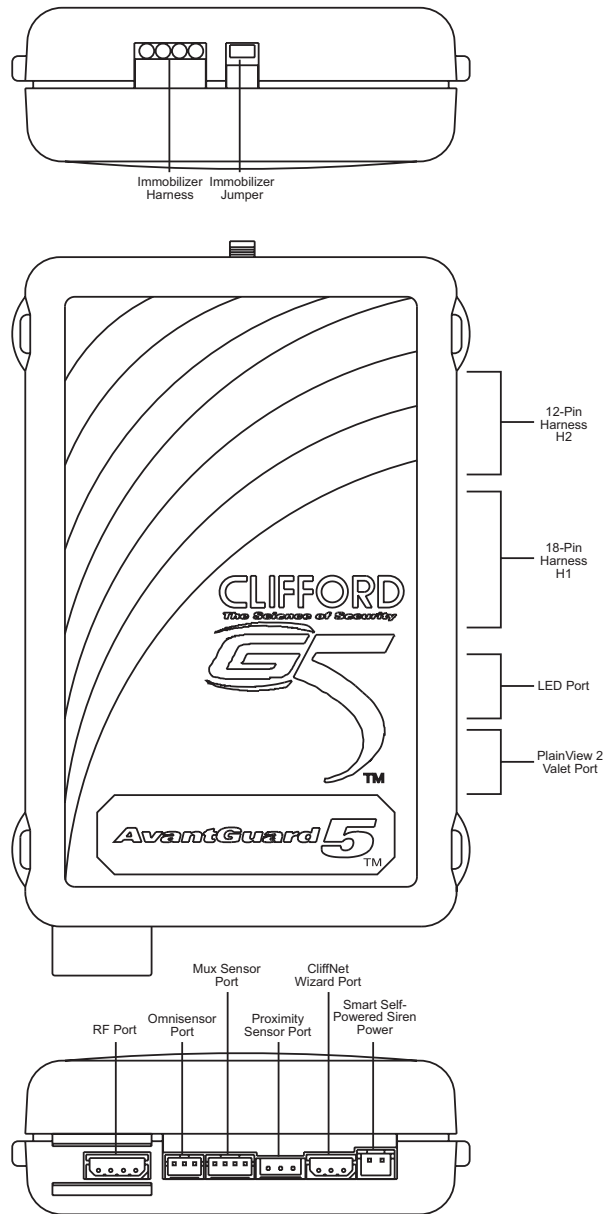

H1 connector

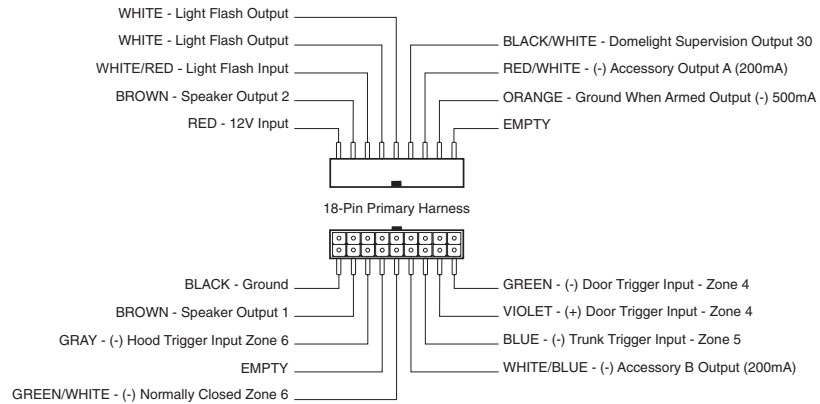

H2 connector

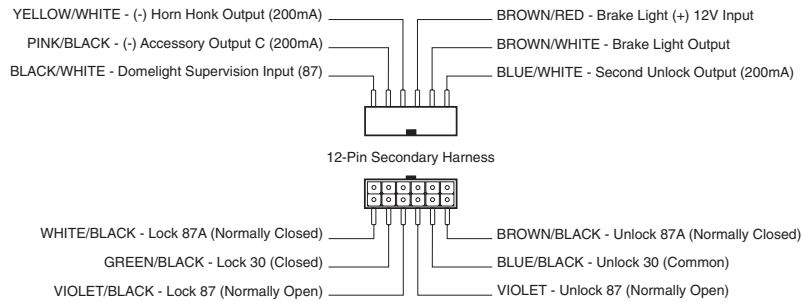

intellistart module connector location

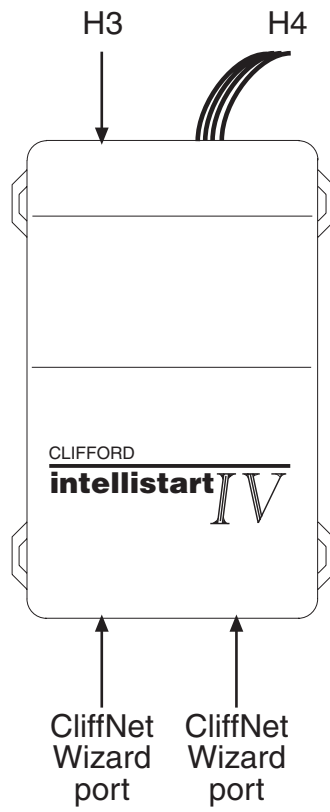

intellistart wiring diagram

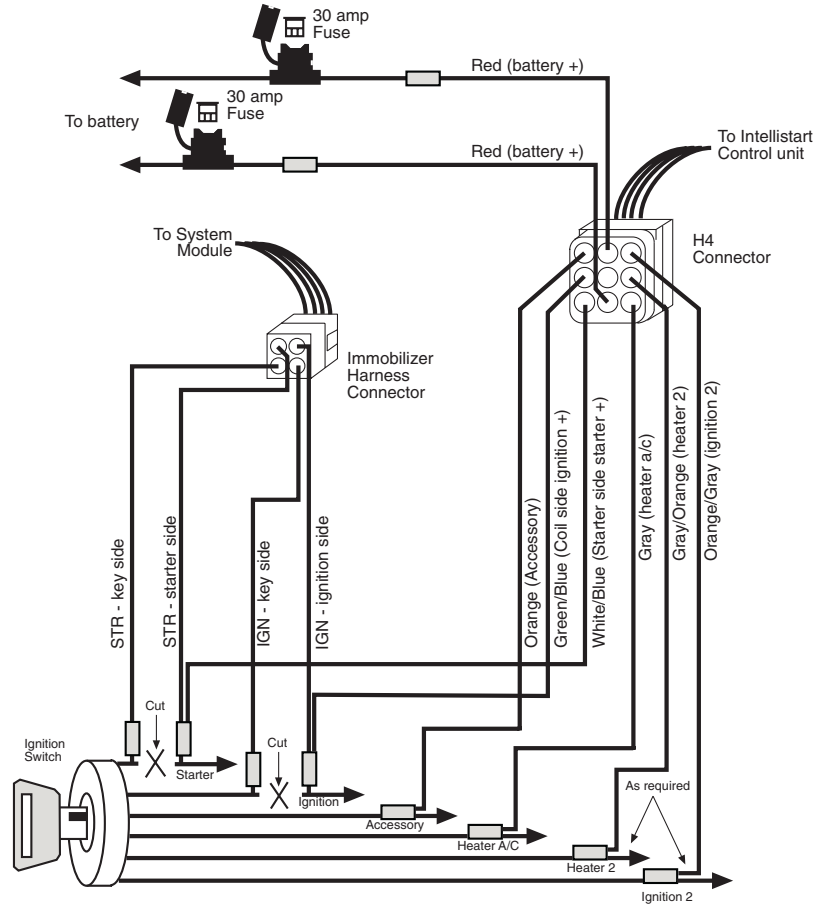

H4 connector

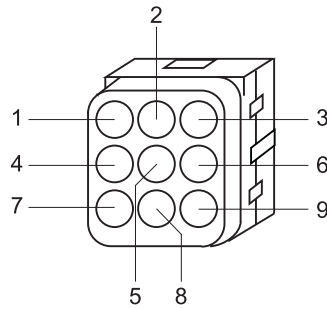

H3 connector

