

# VIPER®

NO ONE DARES  
COME CLOSE™



OWNER'S GUIDE

MODEL  
**5904**



# Congratulations

---

Congratulations on the purchase of your state-of-the-art remote start and security system. Reading this Owner's Guide prior to using your system will help maximize the use of your system and its many features. Please visit [www.viper.com](http://www.viper.com) – for general and additional guide information. For any additional questions please contact your authorized Directed dealer or contact Directed at **1-800-753-0600** (U.S. only).

## What you get

---

Welcome to the best generation of security with remote start. Your system contains everything you need.

- Responder HD remote control with Responder SST technology for superior range and reliability
- 1-way Companion remote control
- AC adapter for charging your remote control
- Full color owner's guide
- Warranty card

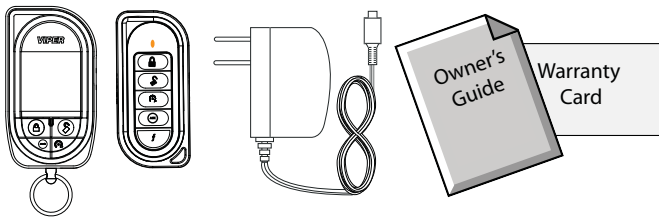

# Important information

---

## Government Regulations and Safety information



**Read** the *Government Regulations* and *Warning! Safety First* sections of this manual prior to operating this system.

**Warning!** Failure to heed this information can result in death, personal injury or property damage and may also result in the illegal use of the system beyond its intended purpose.

## Your Warranty

Your Responder HD system comes with a warranty. Please make sure you receive the warranty registration card and proof of purchase from your dealer indicating the product was installed by an authorized Directed dealer. Please validate it online at [www.prodregister.com/directed](http://www.prodregister.com/directed) or complete and return the warranty registration card.

## Replacement remote controls

If additional remote controls are desired, please see your authorized dealer or visit us at [www.directedstore.com](http://www.directedstore.com) to order. Part numbers are: 7941V for Responder HD 2-way remote control and 7652V for the companion remote control. Your system can also be used with optional Responder LC3 LCD 2-way remote control (7752V).

# Contents

---

Getting Started.....	4
Charging the remote control:.....	4
Keys to using this manual.....	5
Remote Control Information.....	6
Control Center.....	7
Status Screen Icons.....	8
Using your System.....	10
Commands and Confirmations.....	10
Navigation.....	10
Performing Commands.....	10
Fault Condition Alerts.....	11
Basic commands (function level 1).....	12
Arm.....	12
AUX/Trunk.....	12
Disarm.....	13
Remote Start.....	13
Advanced commands: Function Level 2.....	14
Silent Arm.....	14
AUX 1.....	14
Silent Disarm.....	15
Runtime Reset.....	15
Advanced commands: Function Level 3.....	16
Sensor Bypass.....	16
AUX 2.....	16
Remote Valet.....	17
Advanced Start.....	17
Advanced commands: Function Level 4.....	18
Silent Mode 2.....	18
AUX 3.....	18
Car finder.....	19
Defroster.....	19
Advanced commands: Function Level 5.....	20
Car Select.....	20
AUX 4.....	20
Last Trigger.....	21
Temp Request.....	21
Configuring your System.....	22
Navigating menus and configuring features.....	22
Settings Menu.....	24
Button Auto Lock.....	24
Alert Types.....	24
Animations.....	24

Button Beeps .....	25
Paging .....	25
Temp Units .....	25
Adjustments Menu .....	26
Clock Settings .....	26
Timer Start .....	26
Smart Start .....	27
Remote Pair .....	28
Sensor Adjust .....	29
Options Menu .....	31
Power Off .....	31
Parking Meter .....	31
Countdown Timer .....	32
Name Tags .....	33
Demo Mode .....	33
Level 5 Screen .....	34
Alarm Features .....	35
Normal Arm Protection .....	35
Sensor Silent Arm protection .....	35
Full Silent Arm Protection .....	36
Sensor Warn-away Messages .....	36
Full trigger Messages .....	36
Emergency Override .....	36
Trigger Zone Fault Report .....	37
Alarm Trigger Report .....	37
Last Trigger Report .....	38
Nuisance Prevention (NPC) .....	38
Remote Start Features .....	39
Pit Stop Mode .....	39
Key Takeover .....	39
Remote Start Safe-lock .....	40
Disabling Remote Start .....	40
Advanced Start .....	40
Temperature Reporting .....	41
Remote Start Time-out Alert .....	42
Manual Transmission Start (MTS mode) .....	42
Turbo Timer Mode .....	43
Remote Start Not Available .....	44
Remote and System Operations .....	45
Passive Arming .....	45
Auto Re-arming .....	45
Valet Mode .....	46
Power Save .....	46
Rapid Resume .....	46
Automatic Remote Updates .....	46

Out of Range .....	47
No Remote Output .....	47
Feature not Available .....	47
No Function Assigned .....	48
1-way Companion Remote Control .....	49
Accessing Commands .....	50
Sensor Bypass operation .....	50
Button Auto Lock .....	50
Car Select.....	50
Programming .....	51
Battery Information (1-Way) .....	52
System Expansion Options .....	53
Battery Information (Responder HD).....	55
Low Battery .....	55
Battery Life.....	56
Battery Disposal .....	57
Glossary of Terms.....	58
Specifications.....	59
Government Regulations .....	60
Warning! Safety First.....	62
Installation .....	62
Remote Start Capable .....	62
Manual Transmission Vehicles .....	62
Interference.....	64
Upgrades and Batteries .....	64
Water/Heat Resistance .....	64
Limited lifetime consumer warranty .....	65

# Getting Started

---

Your Responder HD remote is powered by an internal rechargeable battery that can only be serviced by an authorized Directed dealer. Due to transit and storage time prior to your purchase, the battery charge may have depleted. To ensure proper operation, check the battery level and connect the battery charger if not fully charged. See *Battery Information* and *Status Screen Icons* sections for more information about the battery.

## Charging the remote control:

1. Plug the AC adapter into a 110V AC outlet. Insert the mini-USB connector into the port on the remote control. The Status screen Info Center then indicates the remote control is charging.
2. While the Status screen is off, the blue transmit LED will continue blinking until fully charged (the remote control also remains functional to command the system or access the Status screen to check the battery level).
3. Once fully charged the remote control is ready for use. Disconnect the mini-USB end from the remote control first and then the AC adapter from the AC outlet.

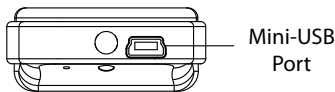

### Note

If the battery is excessively depleted when the charger is connected, functionality may be delayed while it charges to the minimum voltage required to operate the display, after which normal charging resumes.

## Keys to using this manual

Specific actions (in bold type) and style conventions are used consistently throughout this manual, they are as follows:

- **Toggle:** implies rolling the menu wheel up or down and releasing.
- **Press:** implies pushing directly inward on the menu wheel or command button and releasing.
- **Hold:** is used after Toggle or Press actions when the menu wheel or command button needs to be held in position for an extended period of time, typically several seconds.
- **ARMED** this style denotes a still or an animation shown on the HD display, labeled specifically with the command it identifies.
- **Set Clock** denotes highlighted on-screen text when configuring the system or remote control.
- **Blue** text denotes non-highlighted screen titles or on-screen text (such as used in the configuration menus).
- *Italicized* words denote section/sub headings in this guide and can be located through the table of contents.
- An asterisk (\*) when used after a word or phrase denotes that additional details can be found in related sections usually noted at the bottom of the page or end of the section.

# Remote Control Information

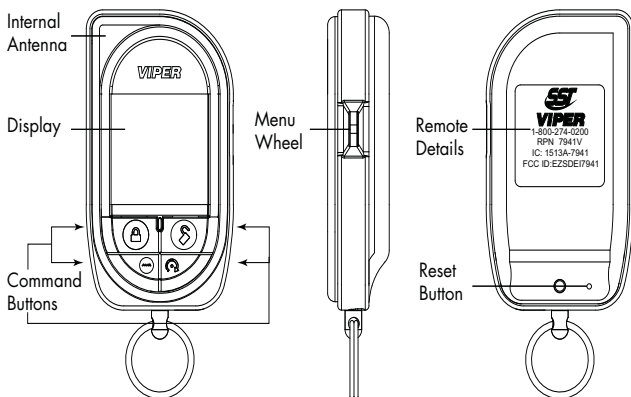

Feature	Description
Internal Antenna*	Used for transmitting and receiving information
Display	Full color display
Command buttons (4):	Used to perform arming, disarming, auxiliary channel and remote start commands
Menu wheel	Used to access Function Level screens, control Status Screen info center content, and navigates the remote control and system configuration menus
Reset Button**	Resets the remote control's microprocessor
Mini USB Port	Used for charging the internal battery (not shown)

\* Avoid touching or grasping the area where the internal antenna is located as it may reduce range.

\*\* Should the remote stop responding to button presses, insert a pin or the end of a paper clip, and press in on the reset button for one second.

## Control Center

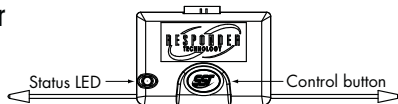

The Control Center, typically located on the upper part of the front windshield sends and receives commands or messages to and from your system. It consists of:

- The In-vehicle system antenna, for 2 way communication.
- The Status LED, as a visual indicator of the system's status.
- The Control button, for placing the system into Valet Mode\* and to perform the Emergency Override\*\* operation.

\* See "Remote and System Operations" on page 45 for details.





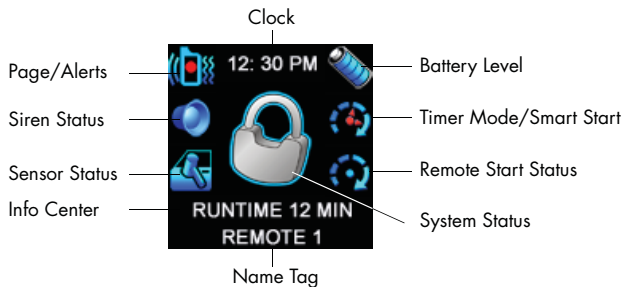







\*\* See "Alarm Features" on page 35 for details.

# Status Screen Icons



The table below describes all the Status screen icons.

Feature	Description
Clock	Indicates the time in 12 or 24 hour format
Battery level	 Full    3/4    1/2    1/4    Empty
Timer Mode / Smart Start	Timer Mode is enabled.     Smart Start is enabled.
Remote Start	Remote start is active, the engine is running.     Manual Transmission Start mode is enabled, the engine can be started
System Status	The system is armed, the alarm is enabled. The system is disarmed, the alarm is disabled. The system is Locked in Valet, the alarm is disabled. The system is Unlocked in Valet, the alarm is disabled. <b>Second system operation:</b> If set to control a second system, the above lock icons will contain a "2".

Feature	Description
Name Tag	Displays a personalized name tag 1-15 characters long
Info Center	Displays the Remote Start runtime, Temperature Auto-report, Parking meter and Countdown timers. While Status screen is on, <b>press</b> the menu wheel to change the displayed information.
Sensor Status	 Trigger Zones are enabled and functioning normally.
	 Trigger zone fault found when arming and is bypassed.
	 NPC On, a sensor has triggered excessively and is bypassed
Siren Status	 Remote Sensor bypass On, the bypassed sensor will not trigger the alarm.
	 Siren is enabled and will sound for all alarm outputs.
	 Siren is disabled for sensor triggers, remote is paged for all triggers (Sensor Silent Arm).
Page/Alerts	 Siren is disabled for all triggers, remote is paged for all triggers (Full Silent Arm).
	 Pager On,  Pager Off.
	 Battery Save On (Red dot), Battery Save Off (No dot).
	 Tone On (icon is not present when Tone is Off).
	 Vibrate On (icon is not present when Vibrate is Off).
	Example  Page Off, Vibrate On & Tone On. Varying combinations of these icons reflect the Paging and Alert Types menu settings.

# Using your System

---

## Commands and Confirmations

Commands, Basic or Advanced, are used to activate system features and are performed by pressing one of the Command buttons. Basic commands control the most often used security and remote start features while Advanced commands control more specialized features and request reports.

Confirmations for Basic or Advanced commands are indicated first by siren chirps and vehicle light flashes, and then as animations, still screens and beeps or tones on the remote control. A description of each feature confirmation is found in the following Basic command and Advanced command sections.

## Navigation

To navigate to the Status and Function level screens, **toggle** the menu wheel up or down, the screens will cycle as shown in the facing diagram. These screens remain displayed for 3 seconds before reverting to a blank screen. To display a screen for an extended 20 second period; **toggle** and **hold** the menu wheel on the desired screen for this duration, after which the display reverts to a blank screen.

## Performing Commands

Perform Basic commands by pressing one of the command buttons while the remote control display is blank or the Status screen is On. Perform Advanced commands by pressing one of the command buttons while a Function Level screen is displayed.

### Advanced command example: Silent Arm

1. **Toggle** the menu wheel to display the [Function Level 2](#) screen.

2. Press the  button while this screen is still on to perform the Silent Arm command.
3. The Responder HD remote will play the **SILENT ARM** animation followed by the Status screen.

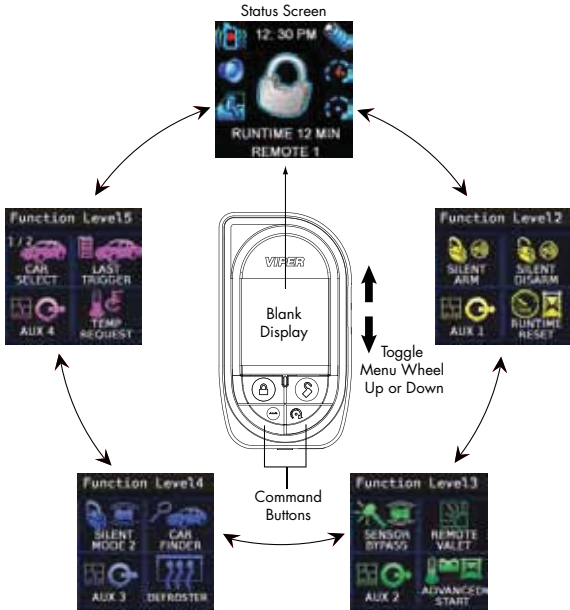

## Fault Condition Alerts

If, when performing a command, a condition exists that does not allow the activation of a feature, a fault screen and tone plays as an alert. For more details on the condition and possible resolutions, use the fault screen title and locate the respective section through the table of contents.

# Basic commands (function level 1)

---

## Arm



Press and release 

The alarm arms, doors lock (if connected), and the siren chirps and lights flash once. The **ARMED** animation and beeps play to confirm. If Valet mode\* is On the doors lock and the **LOCKED (IN VALET)** animation and tone play. Exit Valet mode to arm the alarm normally.

If a trigger zone fault is detected the siren chirps once again and the Trigger Zone Fault report\*\* plays.

## To Arm and Panic

Press and hold 

The alarm Arms (or Locks in Valet) and, after 2 seconds, sounds the siren and flashes the lights. The **PANIC** animation and siren tones play to confirm. Press the  or  button to stop the output.

## AUX/Trunk

Press and hold 

The Trunk opens (if connected) when this button is pressed for 2 seconds. The **TRUNK RELEASE** animation and tones play to confirm.

\* See "Remote and System Operations" on page 45 for details.

\*\* See "Alarm Features" on page 35 for details.

## Disarm

Press and release



The alarm disarms, doors unlock (if connected), and the siren chirps and lights flash twice. The **DISARM** animation and beeps play to confirm. If Valet mode\* is On the doors unlock and the **UNLOCK (IN VALET)** animation and tone play.

More than 2 siren chirps and remote beeps indicates a trigger has occurred. The Disarm animation is then replaced by the Alarm Trigger report.\*\*

## Remote Start

Press and release



Activates (or if On, deactivates) the remote starter. The engine and lights turn On and the **REMOTE START ACTIVATED** animation and On tones play, or the engine and lights turn Off and the **REMOTE START DEACTIVATED** animation and Off tones play to confirm. The Remote Start status icons in the Status screen are updated accordingly. If Remote Start fails to activate, a fault screen and tone plays to identify the reason.\*\*\*

\* See "Remote and System Operations" on page 45 for details.

\*\* See "Alarm Features" on page 35 for details.

\*\*\* See "Remote Start Not Available" on page 44.

For Manual transmission vehicles see the "Manual Transmission Start (MTS mode)" on page 42 for more details.

# Advanced commands: Function Level 2

From blank screen, **toggle** menu wheel down 2 times



## Silent Arm

Press and release 

The alarm arms, doors lock (if connected), and the lights flash once. The **SILENT ARM** animation plays to confirm. Valet mode\* or Trigger Zone Fault report\*\* messages may be received.



## AUX 1

Press and release 

Activates (or if On, deactivates) the Aux 1 output. The **AUX CHANNEL** animation and On tones or Off tones play to confirm.

- \* See "Remote and System Operations" on page 45 for details.
- \*\* See "Alarm Features" on page 35 for details.



## Silent Disarm

Press and release



The alarm disarms, doors unlock (if connected), and the lights flash twice. The **SILENT DISARM** animation plays to confirm. The Alarm Trigger report\* may replace the Silent Disarm animation.



## Runtime Reset

Press and release



If more time is needed while remote start is active, runtime reset will reset the runtime counter to the pre-programmed setting. The **RUNTIME RESET** animation and tones play to confirm. The Remote Start runtime is reset in the Status screen.

### Note

Remote Start must be active to use this feature.

\* See "Alarm Features" on page 35 for details.

# Advanced commands: Function Level 3

From blank screen, **toggle** menu wheel down 3 times





## Sensor Bypass

Press and release  to access menu

The Sensor Bypass menu screen has four options, pressing the appropriate button as shown below activates that bypass level. An appropriate screen and beeps play to confirm.

**Warn away** → Press and release : all sensor warn-away output and messages to the remote are defeated.

**Optional sensors** → Press and release : optional sensor warn-away and full trigger output and messages to the remote are defeated.

**Shock sensor** → Press and release : shock sensor warn-away and full trigger output and messages to the remote are defeated.

**Bypass all** → Press and release : shock and optional sensor warn-away and full trigger output and messages to the remote are defeated.

### Note

System needs to be armed to perform Sensor Bypass.  
Perform arm command any time to turn Sensor Bypass Off.



## AUX 2

Press and release 

Activates (or if On, deactivates) the Aux 2 output. The animation and On tones or Off tones play to confirm.

**AUX CHANNEL**



## Remote Valet

Press and release 

Enters (or if On, exits) Valet Mode. The **VALET MODE ENTER** or **EXIT VALET MODE** animation and beeps play to confirm. See *Valet Mode* for more details



## Advanced Start\*

Press and release 

Displays the Advanced Start menu screen with two options:

**Timer Mode** → Press and release :

Activates (or if On, deactivates) Timer Mode. The lights flash quickly four times for On and slowly four times for Off. The **TIMER MODE ACTIVATED** or **TIMER MODE DEACTIVATED** animation and beeps play to confirm.

**Smart Start** → Press and release :

Activates (or if On, deactivates) Smart Start. The lights flash quickly five times for On and slowly five times for Off. The **SMART START ACTIVATED** or **SMART START DEACTIVATED** animation and beeps play to confirm.

**Note** Advanced Start will not start the engine unless the system has been Armed or Locked In Valet.

\* See "Advanced Start" on page 40 for more details.

# Advanced commands: Function Level 4

From blank screen, toggle menu wheel down 4 times



## Silent Mode 2

Press and release 

Displays Silent mode 2 menu screen with two options:

**Sensor Silent\*** → Press and release 

The alarm arms, doors lock, and the siren chirps and lights flash 3 times. The **SENSOR SILENT MODE** screen and beeps play to confirm.

**Full Silent\*** → Press and release  :

The alarm arms, doors lock, and the siren chirps and lights flash 4 times. The **FULL SILENT MODE** screen and beeps play to confirm.



## AUX 3

Press and release 

Activates (or if On, deactivates) the Aux 3 output. The **AUX CHANNEL** animation and On tones or Off tones play to confirm.

\* See "Alarm Features" on page 35 for details.



## Car finder

Press and release



The siren emits one long chirp and the lights flash for 10 seconds. The **CAR FINDER** animation and beeps play to confirm. The light flashes stop if armed or disarmed while Car Finder is in progress.



## Defroster\*

Press and release



Activates the vehicle Defroster circuit (if connected) while Remote Start is activated. The **DEFROSTER ON** screen and beeps play to confirm. For convenience, the Defroster circuit will also automatically activate 10 seconds after remote starting if the temperature is below 55°F.

### Note

Remote Start must be active to use this feature.

\* This feature must be installed and turned on by an authorized Directed dealer.

# Advanced commands: Function Level 5

From blank screen, toggle menu wheel down 5 times



## Car Select

Press and release 

Sends a request message to the selected car which, if within range, responds with its status information. The **CAR 1** or **CAR 2** screen and beeps play to confirm the change followed by the updated Status screen.

Car 2 must have a Name Tag set in the Options menu before it can be selected. If the selected car does not respond the remote displays the **CAR 1 NOT AVAILABLE** screen (or car 2 if applicable) and remains in the newly selected car mode.



## AUX 4

Press and release 

Activates (or if On, deactivates) the Aux 4 output. The **AUX CHANNEL** screen and On tones or Off tones play to confirm.



### Last Trigger\*

Press and release



Requests a report of the most recent alarm triggers for display on the remote. The last trigger report clears when the ignition is turned on.



### Temp Request

Press and release



Requests the vehicle's interior temperature and temporarily displays it in the status screen info center.

\* See "Alarm Features" on page 35 for details.

# Configuring your System

You can customize the way the HD remote communicates information and adjust a variety of system features in the [Settings](#), [Adjustments](#) and [Options](#) configuration menus. The following features are listed and defined in the same sequential order as they appear on your system.

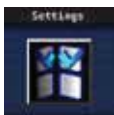

Button Auto Lock  
Alert Types  
Animations  
Button Beeps  
Paging  
Temp Units



Clock Settings  
Timer Start  
Smart Start  
Remote Pair  
Sensor Adjust

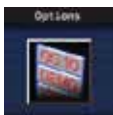

Power Off  
Parking Meter  
Countdown Timer  
Name Tags  
Demo Mode  
Level 5 screen



No features, used  
only to exit menus

## Navigating menus and configuring features

Configuring your system is performed via the menu wheel and command buttons.

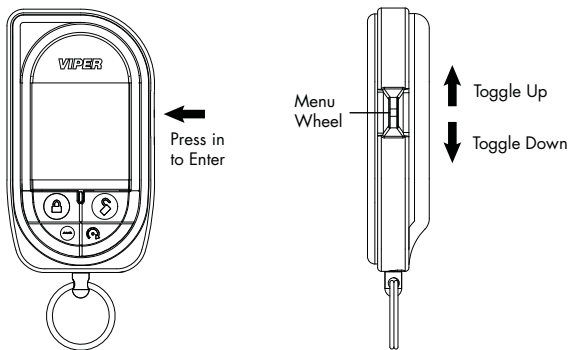

The following instructions discuss how to access and configure the many features available, allowing you to customize your HD remote control to your personal preferences.

**To access the main menu screens** (from a blank display):

1. **Press** and **hold** the menu wheel for 3 seconds, the remote control enters the main menu and displays the **Settings** screen.
2. **Toggle** the menu wheel to scroll through the **Settings**, **Options**, **Adjustments** and **Exit** main menu screens.
3. **Press** the menu wheel to enter a displayed main menu.
4. **Toggle** the menu wheel to highlight a menu item.
5. **Press** the menu wheel to access the menu item screen.

**Making selections, go back and exit:**

6. **Toggle** the menu wheel to move the highlight to the desired configuration and then **press** to set. The selected configuration is indicated by the pointer on the right. Continue to **hold** the menu wheel to return to normal operation or **release** to remain within the menu. Highlight **Back** and **press** to return to the previous menu or continue **holding** to return to normal operation.

**Adjust timers and features**

7. When adjustment screens are accessed, the current settings are displayed. **Toggle** the menu wheel to highlight a settings field and then **press** it to adjust the setting. Follow the on-screen instructions or the description in each feature section to adjust the feature settings.

Menus are automatically exited after a 30 second lapse in button activity.

# Settings Menu

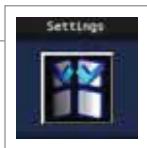

## Button Auto Lock

Options: [ON](#), [OFF](#) (default)

When [ON](#), the remote buttons lock after a 20 second lapse between button presses to prevent unintentional operations. If a button is pressed when locked the **BUTTON LOCK ON** and fault tone play. When [OFF](#), the buttons do not lock and always perform a command when pressed.

To unlock the buttons; **press** the  button followed by the  button, the Status screen and unlock tones play to confirm.

**Auto unlocking:** After turning the ignition off, a message to the remote unlocks the buttons until the next command is performed. If Auto Unlocking is not desired, it can be turned off by an authorized Directed Dealer.

## Alert Types

Options: [Tone](#) (default), [Tone+Vibrate](#), [Vibrate](#), [Screen Only](#)

There are several ways for the HD to alert you when it has received a message from the system. Select [Tone](#) to be alerted by tones that are unique for each message. Select [Vibrate](#) and the HD silently alerts you with a gentle vibration. Select [Tone+Vibrate](#) to be alerted by both, or select [Screen Only](#) when you don't want to be interrupted.

## Animations

Options: [Play All](#) (default), [Triggers Only](#)

Select **Play All** and all available animations and still screens play when a message is received from the system. Select **Triggers Only** and the animations are only played if a message indicating the security system has triggered and the siren is sounding. Screen stills are active for features in this selection.

## Button Beeps

Options: **ON** (default), **OFF**

When Button Beeps are **ON** you hear a beep each time you press a button. These beeps can be turned **OFF** if you prefer silent button presses.

## Paging

Options: **Battery Save** (default), **ON**, **OFF**

Paging is how the HD remote monitors your system's messages. **Battery Save** extends battery life by turning **Paging Off** after 72 hours if the remote control is not used during this period. Just press any button to resume system monitoring. When **ON** it wakes up every few seconds to listen for pages from the system. When **OFF** it does not wake up to receive remote start or alarm trigger pages.

**Note** When off, responses are still received when a command is performed.

## Temp Units

Options: **Fahrenheit** (default), **Celsius**

Temperature can be displayed in your choice of temperature scales.

# Adjustments Menu

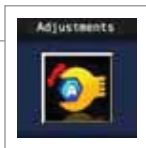





## Clock Settings

Options: [Set Clock](#), [Time Format](#)

Used to adjust the clock and set the Status screen time format.

### Setting the clock

1. **Toggle** to **Clock Settings** and **press** the menu wheel, the [Clock Settings](#) screen is displayed.
2. **Press** the menu wheel to enter the [Set Clock](#) field, or **toggle** to [Time Format](#) to select a [12 Hour](#) or [24 Hour](#) display and **press** the menu wheel on your highlighted choice to set (a pointer to the right indicates your selection).
3. In the [Set Clock](#) field, to adjust and save a new clock setting, follow the on-screen instructions.
  - Menu wheel: **Press** the menu wheel to highlight the character to be adjusted. **Toggle** to adjust up/down.
  -  or  : **Press** to highlight the character to be adjusted.
  -  : **Press** to reset the clock.
  -  : **Press** to save new settings and go back to the [Clock Settings](#) screen.

## Timer Start\*





Options: [How Many? \(Starts\)](#), [How Often? \(Hours\)](#)

The Timer Start adjustment screens are used to set how many times (1 - 24 starts) and how often (every 1-24 hours) the Timer Mode feature starts the engine, when enabled.

### Note

Before beginning adjustment the system must be in communication range of the remote and in the disarmed state.

## Setting Timer Start

1. **Disarm** the system then access the Adjustments feature menu.
2. **Toggle** to **Timer Start** and **press** the menu wheel, the **Timer Start** screen with current setting is displayed. If the system is not ready the **NO FUNCTION ASSIGNED** screen and tone plays. Return to Step 1.
3. **Press** the menu wheel to enter the **How Many? (Starts)** field or **toggle** and press to enter the **How Often? (Hours)** field.
4. To adjust and save new settings follow the on-screen instruction.
  - Menu Wheel: **toggle** to adjust the setting up/down.
  -  or  : **Press** to adjust the setting up/down.
  -  : **Press** to reset the setting to default.
  -  : **Press** to delete new settings and go back to the Adjustment feature menu.

\* See "Advanced Start" on page 40 for more details.

## Smart Start\*

Options: **Low Temp Start**, **High Temp Start**





The Smart Start adjustment screens are used to set the low temperature and high temperature thresholds the Smart Start feature uses to start the engine, when enabled.

**Note** Before beginning adjustment the system must be in communication range of the remote and in the disarmed state.

### Setting the Low and High Temperature thresholds:

1. **Disarm** the system then access the Adjustments feature menu.
2. **Toggle** to **Smart Start** and **press** the menu wheel, the **Smart Start** screen with current setting is displayed. If the system is not

ready the **NO FUNCTION ASSIGNED** screen and tone plays, return to Step 1.

3. **Press** the menu wheel to enter the **Low Temp Start** field or **toggle** and **press** to enter the **High Temp Start** field.
4. To adjust and save new settings follow the on-screen instructions.
  - Menu Wheel: **Toggle** to adjust the setting up/down. **Press** to save new settings and go back to the Adjustments feature menu.
  -  or  : **Press** to adjust the setting up/down.
  -  : **Press** to reset the setting to default.
  -  : **Press** to delete new settings and go back to the Adjustment feature menu.

\* See Smart Start under "Advanced Start" on page 40 for more details.

## Adjusting Battery Level:

The battery level threshold for the Smart Start feature is preset to On-10.5 volts; your authorized Directed dealer can adjust this setting within the 9 to 12 volt range or to Off.



## Remote Pair

Remote Pair is a process where the Responder HD and the system in the vehicle learn each others encrypted identification, securing their communication from intruders. Please note that your remote controls come pre-programmed from the factory.

## How to Remote Pair

Make sure the remote control is set for the desired Car 1 or Car 2 operation for the system it is to be paired with.

Placing the system into the remote pair mode

1. **Open** one or more of the vehicle doors.
  2. **Turn** the ignition to the On position.
  3. **Press**, release, then **press** and **hold** the Control button (on Control Center).
  4. The control center LED begins to flash and the siren emits one chirp to confirm the system is in Pair mode, the Control button can be released. The system will stay in Pair mode for 60 seconds or until the doors are closed or ignition turned off. The siren will emit one short and one long chirp when it exits remote pair mode.
- 
1. **Toggle** to **Remote Pair** and **press** the menu wheel, the **Remote Pair** screen with on-screen instructions is displayed.
  2. **Press** and **hold** the  button. The remote's LED flashes, then the siren chirps, and remote tones play to confirm pairing. The **PAIRING SUCCESSFUL** screen is displayed before returning to the Adjustments feature menu screen.
  3. If the remote does not learn the system ID it displays the **PAIRING FAILED** screen after the button is released before returning to the Remote Pair screen. **Press** and **hold** the  button to try again. If the siren chirps but remote tones are not played, **Press** and **hold** the  button to try again until the tones are played. If the siren does not chirp shortly after the remote LED begins flashing make sure the system is in remote pair mode.

## Sensor Adjust

Your Responder HD security with remote start system has a built in shock sensor used to detect intrusion attempts on your vehicle. The sensor sensitivity can be adjusted to optimize your vehicle's detection

levels without generating false alarms.

If you feel your security system shock sensor is too sensitive or not sensitive enough, it is highly recommended that you contact your authorized Directed dealer/professional and have the sensor adjusted for optimized security detection performance.

# Options Menu



## Power Off

Options: [Power Off](#)

With **Power Off** highlighted, **press** the menu wheel, the **POWER OFF** animation and tones play to confirm. When an extended period of non-use is anticipated turning the power off will preserve the battery charge.

To turn the remote on, **Press** and **hold** the menu wheel for 3 seconds, the **VIPER** animation and On tones play to confirm the remote control is ready for normal operation. The remote also turns itself on and begins charging when the battery charger is connected.





## Parking Meter

Options: [Start Meter](#), [Parking Meter Set](#)

The Parking Meter tracks and alerts you to the time remaining when parked in a metered parking spot. As the metered time runs out the remote control emits alerts at 15 minutes remaining (1 beep) and 5 minutes remaining (2 beeps). At expiration the **PARKING METER TIMER EXPIRED** animation and 4 beeps are played followed by an alert output of 2 beeps each minute for 10 minutes. The next button press replays the animation and stops the alert output, a command is not performed.

### Starting and Setting the Parking Meter

1. **Toggle** to **Parking Meter** and **press** the menu wheel, the [Parking Meter](#) screen with current setting is displayed.
2. With **Start Meter** highlighted, **press** the menu wheel to start the meter or **toggle** the Menu Wheel to enter the [Parking Meter Set](#) field.

- To adjust and save a new meter setting follow the on-screen instructions.
  - Menu wheel: **Press** to highlight the digit to be adjusted. **Toggle** to adjust the setting up/down.
  -  or  : **Press** to highlight the digit to be adjusted.
  -  : **Press** to reset the meter.
  -  : **Press** to save new setting and go back to the Parking Meter screen.

### To Stop, Start and Clear the Parking Meter time (in the Info Center):

- With the Status screen displayed, **press** and **hold** the menu wheel for 3 seconds, the colon in the timer meter stops blinking and 2 beeps are emitted to confirm the meter has stopped. The meter remains in the display.
- Press** and **hold** again for 3 seconds to restart the meter (the timer meter colon begins blinking again).
- Press** and **hold** for 6 seconds any time, the timer will clear from the display.

## Countdown Timer

Options: [Start Timer](#), [Countdown Timer Set](#)

Your Responder HD remote control has a feature for setting a countdown timer designed to be used as a reminder only. At expiration the **COUNTDOWN TIMER EXPIRED** animation and 4 beeps play followed by an alert output of 2 beeps every minute for 10 minutes.





Setting, Stopping, Starting and Clearing of the Countdown timer and alert uses the same process as previously described for the [Parking Meter](#).

## Name Tags

Options: [Set Name Tag1](#), [Set Name Tag2](#)

Name tags allow you to personalize your Responder HD remote control by adding a unique name to the Status screen for the system it controls. For Name Tag 1; [Remote 1](#) is the default setting. Name Tag2 is used when your Responder HD remote control is used to control a companion system in another vehicle. For more details on Name Tag2, please contact your authorized Directed dealer.

### Setting the Name Tags

1. **Toggle** to **Name Tags** and **press** the [Name Tags](#) screen is displayed.
2. **Toggle** to **Set Name Tag1** or **Set Name Tag2** and **press** the menu wheel to enter the field.
3. To set and save a name tag follow the on-screen instructions.
  - Menu wheel: **Toggle** the menu wheel up/down to adjust the highlighted character. **Press** to move the highlight to the next character on the right.
  -  or  : **Press** to highlight the character to be changed.
  -  : **Press** to delete all characters.
  -  : **Press** to save the name tag and go back to the [Name Tags](#) screen.

## Demo Mode

Options: [Demo Once](#), [Demo Once muted](#), [Demo loop](#), [Demo loop muted](#)

[Demo Mode](#) plays a pre-selected group of animations as a demonstration tool to show friends or family. Running it shortens the battery life over time if used excessively. Please note that the accelerated

battery depletion caused by this using this feature can result in a dead battery. Use sparingly to maintain battery life.

[Demo Once](#) plays the animations once with tones and beeps; [Demo Once Muted](#) plays animations only.

[Demo Loop](#) plays the animations continuously with tones and beeps; [Demo Loop Muted](#) plays animations only.

**Note** The supplied battery charger must be connected to your Responder HD remote control for [Demo Loop](#) or [Demo Loop Muted](#) to operate.

## Level 5 Screen

Options: [Aux 4](#) (default), [Garage](#)

This feature allows you to choose the Function level 5 screen according to your system's configuration. [Aux 4](#) is for normal use as an auxiliary channel output. [Garage](#) is for use as an optional garage door opener. For more details on these settings, please contact your authorized Directed Dealer or call 1- 800 - 753-0600.

# Alarm Features

---

## Normal Arm Protection

**Status LED:** The Control Center Status LED flashes as a visual indicator that your vehicle's security system is active.

**Starter Kill:** The Failsafe starter kill relay prevents the engine from starting

**Note** May require additional parts and installation

**Sensor triggers:** The onboard shock sensor can distinguish minor impacts from major impacts to the vehicle exterior. Minor impacts causes the system to emit a Warn-away output by chirping the siren and flashing the parking lights for 3 seconds. Major impacts caused for example by a forcible entry attempt, results in a Full Trigger output. The siren sounds and the lights flash for 30 seconds or longer. Both Warn-away and Full Triggers send a message to the remote control.

**Point of entry triggers:** Opening the Hood or Trunk causes a Full Trigger output, while opening a Door or turning on the Ignition causes the the siren to chirp 3 seconds before beginning the Full Trigger output. This 3 second delay allows time to disarm and silence the siren in case of accidental trigger. The Full Trigger message is still sent to the remote.

## Sensor Silent Arm protection

Sensor warn-away and Sensor full trigger activations only send messages to the remote, while the vehicle's light flash and siren outputs are defeated. Point of entry triggers will activate the light flash, siren, and send messages normally.

## Full Silent Arm Protection

Sensor warn-away, Sensor full trigger and Point of entry activations will only send messages to the remote, with vehicle light flash and siren outputs defeated.

## Sensor Warn-away Messages

When the remote receives a Sensor Warn-away message it emits 10 beeps (if on) and plays a sensor zone specific **WARN AWAY** animation once. Warn-away messages cannot be reviewed or displayed in reports.

## Full trigger Messages

A Full Trigger message generates a Full Trigger output of siren tones and zone specific **TRIGGER** animation for 15 seconds followed by an alert that consists of 2 beeps per minute for 10 minutes.

To stop the output and alert, **press** a command button to perform a command, or **toggle** the menu wheel. If the output is not stopped, the next press or toggle of the remote control buttons or wheel replays the zone specific **TRIGGER** animation for review before returning to normal operation.

## Emergency Override

The following procedure disarms the system when a programmed remote is not available. Number of presses \_\_\_\_\_

1. **Turn** the ignition On.
2. **Press** the control button on the Control Center the correct number of times (the default is 1 press).
3. After a few seconds the siren output ceases and the system is disarmed.

**Note** As a precaution, if programmed for Passive Arming or Auto re-arming the system should be placed into Valet Mode until a remote is available .

## Trigger Zone Fault Report

When armed by remote command the system runs a status check of the alarm trigger zones. Faulty zones (usually caused by dome light delay or open trunk) are bypassed and reported via the control center LED and remote, while all other trigger zones remain active and are monitored to protect the vehicle. Should a faulty zone self correct (dome light turns off) it becomes active and is then monitored normally.

The siren chirps once again a few seconds following the arming chirps as an audible alert, the control center LED flashes in groups to indicate the zone number. The remote emits a fault tone, displays a screen for each faulty zone, and then updates the Sensor status icon in the Status screen. **Press** any button within 20 seconds of the fault tone to review the report without performing a command.

## Alarm Trigger Report

The most recent alarm triggers (if any) are reported when the alarm is disarmed via the remote control, siren chirps, parking light and control center LED flashes. The siren chirps 4 times (or 5 times if NPC On\*), the lights flash 3 times, and the control center LED flashes in groups to indicate the last two zones that were triggered (see Table of Zones). The remote control Disarm output is replaced by screens and beeps that identify the two most recent triggers.

\* See "Nuisance Prevention (NPC)" on page 38 for more details.

Table of Zones

Zone # (led flashes)	Zone Name
1	Trunk
2	Shock Sensor
3	Door
4	Optional Sensor
5	Ignition
6	Hood

## Last Trigger Report

The Last Trigger report displays the two most recent alarm triggers depending on the system state when requested. When disarmed, the report will display screens for the two most recent Alarm Zone triggers since the vehicle was last driven. When armed, the report will display screens for two most recent Alarm Zone triggers since the system was armed.

**Note** The last trigger report clears when ignition is turned on.

## Nuisance Prevention (NPC)

NPC monitors all alarm zones and, if any are triggered excessively, bypasses them until corrected. If a point of entry (trunk, hood, door) is left open following a forced entry, it is bypassed. It becomes active again only after being closed.

Sensors that trigger excessively are bypassed and reported to the remote via Sensor Status icon in the Status Screen, and by NPC On screens that are displayed during the Disarm Trigger and Last Trigger reports.

Bypassed sensors automatically reset after one hour and after the vehicle is driven. Disarming then re-arming the alarm does not reset bypassed sensors.

# Remote Start Features

---

## Pit Stop Mode

To exit vehicle with engine running

The system keeps the engine running during short trips into the house or convenience store. To perform Pit Stop:

1. With the engine running, **set** the parking brake and **release** the foot brake.
2. **Press** the  button, the vehicle lights will turn on and the remote will play the **REMOTE START ACTIVATED** message.
3. **Turn** the key to off, and **remove** it from the ignition, the engine continues running for the programmed runtime.
4. **Exit** the vehicle and **arm** the alarm.

**Note** For Pit Stop on manual transmission vehicles, follow the directions in the *Manual Transmission Start (MTS mode)* section found further into *Remote Start Features*.

## Key Takeover

When you are ready to drive

The system keeps the engine running until the vehicle is ready to be driven. To perform Driver Takeover:

1. **Disarm** the system and **enter** the vehicle, do not step on the foot brake.
2. **Insert** the key, **turn** it to the run position, and then **step** on the foot brake, the remote start then turns off.

3. The vehicle lights turn off to indicate remote start is off, and then after a few seconds the remote plays the **REMOTE START DEACTIVATED** message.
4. The vehicle is ready to drive.

## Remote Start Safe-lock

Remote start safe-lock makes sure the doors are locked when Remote Start is activated and after it is deactivated, even if they are unlocked when remote start is activated. Door locks may require additional parts and labor.

## Disabling Remote Start

Remote start can be disabled by moving the Toggle Switch to the Off position. If remote start is attempted while Off, the engine will not start and a message will let you know the switch is Off. (See *Remote start not available*) move the switch back to the On position to resume normal operation.

Toggle Switch location: \_\_\_\_\_

## Advanced Start

The Advanced start Timer Mode and Smart Start features automatically start the engine as set in the Adjustments menu.

### Precautions for the Advanced Start features:

- Park the vehicle in a well ventilated area away from windows and doors that lead into inhabited spaces.
- Arm and Lock the vehicle, the engine will not start unless the doors are locked.
- Only one Advanced start feature can be enabled at any given time.
- For manual transmission vehicles MTS mode must be enabled

before Advanced start can be activated.

## Timer Mode operation

Activation begins a countdown timer as set in the [How Often? \(Hours\)](#) screen of the Adjustments menu (default 3 hours). When the timer expires the engine starts and the **REMOTE START ACTIVATED** message is sent to the remote control. When the Remote start runtime expires the engine shuts off, the **REMOTE START DEACTIVATED** message is sent to the remote control and the countdown timer restarts. This will repeat as many times as set in the [How Many? \(Starts\)](#) screen of the Adjustments menu (default 6 starts). Timer Start is exited after the final start.

## Smart Start operation

Smart Start uses the “Hours” and “Starts” settings used in Timer Mode in addition to temperature to automatically start the engine. Activation begins the countdown timer. When the timer expires the vehicle interior temperature is checked and, if it exceeds the temperature thresholds as set in the [Low Temp](#) and [High Temp](#) screens of the Adjustments menu, the engine starts and the **REMOTE START ACTIVATED** message is sent to the remote control. When the Remote start runtime expires the engine shuts off, the **REMOTE START DEACTIVATED** message is sent to the remote control and the countdown timer restarts. Smart Start is exited after the final start.

### Note

The vehicle battery voltage is also monitored and if below 10.5 volts the engine will start. The battery threshold can be changed by an authorized Directed dealer if a higher or lower threshold is desired.

## Temperature Reporting

During Remote start the vehicle interior is checked regularly for tem-

perature changes. If a change in temperature is detected this report will be sent to the remote for display. Each time the remote receives this report it will beep, update, and display the newest temperature information in the Status screen info center.

**Note** Temperature report must be turned on by an authorized Directed dealer.

## Remote Start Time-out Alert

During remote start a message is sent three minutes before and again at one minute before the engine turns off. The **REMOTE START TIMEOUT IMMINENT** animation and tones play as an alert to reset the runtime if desired.

## Manual Transmission Start (MTS mode)

When installed into a manual transmission vehicle, the system requires that the MTS mode is properly set when parking. If MTS mode is not properly set or is defeated after being properly set the system will not start the engine and the **REMOTE START NOT AVAILABLE** screen and tones play as an alert.

1. With the engine running, **set** the parking brake and leave the engine running. For Pit Stop or Turbo Timer mode (to leave the engine running after arming) **open** the driver door.
2. **Release** the foot brake (if pressed during Step 1), or **press** and **release** the foot brake anytime. As long as the engine is running there is no time limit to perform this step.
3. Within 20 seconds of foot brake release, **press** any command button on the remote, after 20 seconds return to Step 2 (For Turbo Timer Mode, press the optional dash mounted activation button or send the Timer Mode command from the Advanced Start menu

screen).

4. The vehicle lights flash 5 times to confirm MTS mode enable and the remote start activates the ignition outputs. The **REMOTE START ACTIVATED** animation and beeps play to confirm.
5. **Turn Off** and **remove** the key from the ignition switch, the engine remains running.
6. **Exit** the vehicle, **close** all the doors and **arm** the system.
7. The engine turns off and after a few seconds, the **REMOTE START DEACTIVATED** message plays to confirm. If the door is opened in Step 3 then the engine continues to run.

## Turbo Timer Mode

The system keeps the engine running for the Turbo Timer runtime and can be activated by remote control or optional dash mounted activation button.

1. With the engine running, **set** the parking brake.
2. Within 20 seconds, **press** the optional dash mounted activation button **or send** the Timer Mode command from the Advanced Start menu screen.
3. The vehicle lights turn on and the remote start activates the ignition outputs. The **REMOTE START ACTIVATED** animation and beeps play to confirm.
4. **Turn Off** and **remove** the key from the ignition switch, the engine remains running.
5. **Exit** the vehicle, **close** all the doors and **arm** the system.
6. The engine runs for the Turbo Mode runtime.

**Note** Turbo Timer must be turned on by an authorized Directed dealer.

## Remote Start Not Available

For user safety, the system must be properly configured or remote start will not activate. Refer to the table below for the screens and parking light flashes that will identify the configuration issue and resolution.

Fault Message	Flashes *	Solution
<b>BRAKE ON</b>	5	Release foot brake
<b>HOOD OPEN</b>	6	Close hood
<b>REMOTE START NOT AVAILABLE</b> If displayed after a Remote Start command: <ul style="list-style-type: none"><li>• MTS mode isn't enabled</li></ul> If displayed after an Advanced Start command it may be one of the following: <ul style="list-style-type: none"><li>• MTS mode isn't enabled</li><li>• Brake is on</li><li>• Hood is open</li><li>• Toggle switch set</li><li>• Alarm triggered</li></ul>	7  Enable MTS mode  Enable MTS mode Release foot brake Close hood Reset switch Check alarm status	
<b>TOGGLE SWITCH</b>	8	Reset switch or place shifter in park position
<b>ALARM TRIGGERED</b>		Check alarm status

\* Refers to the number of parking light flashes.

# Remote and System Operations

---

## Passive Arming\*

Park and exit the vehicle, after the doors are closed the Passive arming countdown begins. The led flashes quickly and upon reaching 20 seconds the siren then chirps once. At 30 seconds the system arms itself.

Anytime before the system arms you can re-enter the vehicle or open the trunk to load or unload items and, after closing passive arming resumes.

To stay secure in case of accidental disarming the system, if a door is not opened within 30 seconds the system re-arms itself and locks the doors.

## Auto Re-arming\*

Auto re-arm ensures the vehicle stays protected if it is not entered after disarming by remote control. After disarming by remote, the alarm automatically re-arms itself (and locks the doors if programmed on) in 30 seconds. Open any point of entry to stop the re-arm until the next disarm by remote.

## Onetime Bypass\*

**Turn** the ignition On for one to three seconds and then Off. The siren chirps once to confirm one-time bypass is enabled.

One-time bypass can be used to temporarily bypass the Passive arming operation for one cycle. It also bypasses the comfort closure and auxiliary channel outputs programmed to activate when arming. After the next disarm all operations return to normal.

\* These features must be turned on by an authorized Directed dealer.

## Valet Mode

Valet mode can be entered and exited by performing the Remote Valet command or manually using the vehicle key and the control button. When entered, the alarm functions are defeated while the convenience features still operate normally.

Arm and Disarm commands lock and unlock the doors while the **LOCKED IN VALET** and **UNLOCK IN VALET** animations and beeps play to confirm.

Use the following steps to manually enter and exit Valet Mode:

1. **Turn** the ignition switch On and then Off
2. Immediately **press** and **release** the control button once
3. The control center LED turns On when entering and Off when exiting.

## Power Save

To reduce power consumption the control center status LED modifies its output if the vehicle is parked for an extended period. If Armed the flashing is reduced after 24 hours. When Valet mode is On, the LED turns off after 1 hour and resets each time the ignition is turned off.

## Rapid Resume

If power is ever disconnected by a mechanic or thief, the system will resume the state it was in at the time of disconnection, when power is reconnected.

## Automatic Remote Updates

The system sends a silent message to all remote controls after any major action has occurred. When the remote receives this message it updates the status screen icons. This way all users are able to quickly review the system status just by accessing the status screen.

## Out of Range

Each time a command is performed the remote will expect a command response from the system. If a command response is not received the **OUT OF RANGE** screen and tone plays as an alert.

## No Remote Output

Occasionally when a command is performed the remote may not generate a command response output or Out of Range output. This indicates that the system received the command but it was an incomplete command (e.g. AUX button press too short to activate the trunk release) or it was an illegal message (e.g. the command was corrupted due to local RF interference). These are temporary normal functions of the system and remote, perform the command again within 10 seconds to return to normal operation.

## Feature not Available

The **FEATURE NOT AVAILABLE** message is a generic one which varies in cause and solution depending upon the command used:

Command	Cause	Reason/Solution
Runtime Reset	Remote Start is Off	Only available when Remote Start is On
Sensor Bypass	System is not armed	Only available when system is armed
Defroster	Remote Start is Off. Not configured for this.	Only available when Remote Start is On. Only available when configured for Defroster control.
Car Select	Car 2 name tag is not set. Car 1 or Car 2 is out of range.	Set Car 2 name tag to activate Car 2 capability. Move to within range .

## No Function Assigned

The HD remote is designed for one button activation, all commands can therefore be performed using one hand. If more than one button is pressed at a time, the **NO FUNCTION ASSIGNED** screen and tone plays as an alert.

# 1-way Companion Remote Control

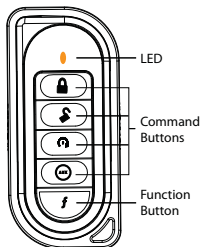

	Basic Commands	Advanced Commands			
	(Function Level 1)	Function Level 2	Function Level 3	Function Level 4	Function Level 5
Level Button	Direct Access	<b>f</b> x 1	<b>f</b> x 2	<b>f</b> x 3	<b>f</b> x 4
	Arm/Lock (Panic)	Silent Arm	Sensor Bypass	Sensor Silent Mode	Full Silent Mode*
	Disarm/Unlock	Silent Disarm	Remote Valet	Car Finder	
	Remote Start	Runtime Reset	Timer Mode*	Smart Start*	Defroster*
	Aux/Trunk	AUX 1	AUX 2	AUX 3	AUX 4
<b>f</b>	Not Used	Used to access function levels for Advanced Commands ( <b>f</b> with multiplier in third row implies button presses)			

\* These Function Level commands on the 1-way do not reside in the exact same Function Level location as on the HD remote control.

## Using the 1 way companion remote

The companion 1 way remote commands the system features as shown in the previous table, but without the message display of the Responder HD remote. Siren chirps and vehicle parking light flashes are used to indicate that a command has been received and activated as described in the *Basic* and *Advanced command* sections.

## Accessing Commands

Similar to the HD remote, Basic commands are performed when a command button is pressed directly. To perform Advanced Commands **press** the **f** button 1 to 4 times to access function levels, **f** x4 in the table for example implies pressing **f** 4 times. The LED flashes in groups for a few seconds to indicate the level. **Press** the desired command button while the LED is flashing to perform the command.

## Sensor Bypass operation

The lights flash each time this command is received to indicate the Sensor bypass type. 2 flashes indicates sensor Warn-away zones are bypassed, 3 flashes indicates sensor Warn-away and Full Trigger zones are bypassed. 1 flash indicates sensor bypass is off.

## Button Auto Lock

When On, the remote control buttons lock if more than 20 seconds lapses between button presses. If a button is pressed when locked, a fault tone is emitted. To unlock the buttons; **press** the **f** button followed by the  button, the buttons unlock and tones play to confirm.

## Car Select\*

Car 2 must first be turned On (See *Remote Features menu* under the following *Programming* section to turn on). **Press** and **hold** the **f** but-

ton for 3 seconds. The remote flashes the LED and beeps once or twice to indicate the selected Car is 1 or 2, **release** the button for Car Select or continue to **hold** for programming.

**Release** the **f** button, then **press** and **release** while the LED and beeps continue to perform Car Select. Once the car is selected a command can be performed by pressing one of the command buttons.

\* See *System Expansion Options* for more details .

## Programming

To enter; **hold** the **f** button for 8 seconds, the remote emits one long beep and turns the LED on, the programming main menu has been accessed.

To exit; **press** and **release** the **f** button to go back and repeat to exit. 1 short and 1 long beep is emitted for each step back, the LED turns off when programming is exited.

## Sensor Adjust

The  button is used for sensor adjustment, to avoid unintended alarm triggers, it is recommended that an authorized Directed dealer perform all sensor adjustments.

## Remote Features menu

**Press** and **release** the  button, 2 LED flashes and beeps indicate the remote features menu is accessed and can be set. **Press** buttons indicated below, 1 beep and flash turns the feature on, 2 beeps and flashes turns the feature off.

- Autolock feature: Press  to turn on/off.
- Remote Beeps: Press  to turn on/off.
- Car 2 feature: Press  to turn on/off.

## Remote Learning

Press the  button, 3 LED flashes and beeps indicates the remote is ready to program to the system.

Per the instruction in the *Remote Pair* section of this guide, following step 4 of *Placing the system into the remote pair mode*. **Press** and **hold** the  button, the siren emits one long chirp to confirm the remote has been learned.

## Battery Information (1-Way)

The 1way companion remote is powered by one 3V coin cell lithium battery (P/N CR-2032) that should last approximately one year under normal use.

### Battery Replacement

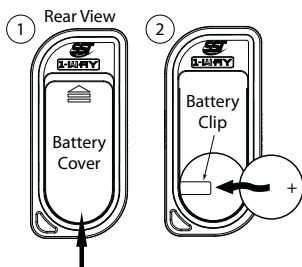

1. Slide the battery cover up by applying equal pressure at its top and bottom (the arrow on the cover indicates the direction), remove the cover from the remote control housing.

2. Gently pry up on the battery to remove it from the holder. Insert a new battery into the holder and under the clip with the positive (+) side up.

Replace the battery cover. The remote control is now ready for use.

# System Expansion Options

---

## Controlling two vehicles (Car Select)

The Responder HD and 1 way companion remote can control systems in two different vehicles saving the need for multiple remote controls. This feature also allows for customized system configurations on each vehicle that has more than one driver. See *Owner Recognition* for details.

When you select the car you wish to control, the remote control sends a request to the selected car which, if within range, responds with its system status information. The remote then displays the new car screen followed by the updated status screen. If the newly selected car does not respond the remote control then displays the **CAR 1 NOT AVAILABLE** screen (or Car 2 if applicable) and remains in the newly selected car mode.

## Owner recognition

The system can be configured to recognize the remote used when disarming and change selected features to match the remote users preferences. Memory seat adjustment, siren chirps, passive arming, remote button auto unlocking, alarm output duration can all be custom set for each remote user at the time of installation.

## Comfort closure

Comfort Closure emulates turning the key in the door cylinder or holding the lock button of an OEM keyless entry. It will automatically close the windows and sunroof on vehicles with this type of OEM convenience feature.

## Alarm output duration

The length of time the siren sounds can be adjusted from 1 to 180

seconds at the time of installation.

### **Arming and warn-away chirp control**

The system arm, disarm and sensor warn-away chirps can be configured for those that prefer a custom silent alarm operation.

### **Driver door priority unlocking**

The door unlocking operation can be configured to emulate an OEM style of driver priority unlocking for added security during disarming.

### **Auxiliary Channels**

The Auxiliary Channel outputs of this system can activate many of the convenience features found in today's vehicles. Once a command is performed to activate a convenience feature the Responder HD displays an animation that matches the feature. The system installer can clarify if any of the below listed features are compatible with your vehicle.

- Trunk release
- Windows open/close
- Left Sliding door open/close
- Right Sliding door open/close
- Rear Hatch open/close
- Sunroof open/close
- Audio system
- Headlights

# Battery Information (Responder HD)

The Responder HD remote control is powered by an internal rechargeable battery that can be serviced only through an authorized Directed Electronics dealer. The information and precautions in this section can help maximize your battery's life and usage in providing your Responder HD remote control with many years of trouble free operation.

The battery information for the 1way companion remote control can be found in the *1-way Companion Remote Control* section of this manual.



**Warnings!** NEVER connect the supplied AC adapter to products other than the Responder HD remote control. It is a high current device designed specifically for rapid charging of the Responder HD battery and may cause severe damage or explosion when connected to any other products.

Charging the battery when the temperature is below 32°F (0°C) or above 113°F (45°C) may cause severe battery damage and/or reduce battery life. Avoid placing the remote control in areas exposed to extreme cold or heat (direct sunlight) when charging the battery.

Battery

## Low Battery



After a command is performed the Responder HD and 1way companion remote controls check their battery level and, when the level requires attention, will begin generat-

ing alerts. Once the alerts begin they will continue to command the system for several days but should be charged at the earliest opportunity or failure to control the system may occur.

## Low Battery Alerts

When disarming the system using a remote control with a low battery the siren will emit one additional chirp as an alert. If confirmation chirps are programmed off, the system will still emit one chirp as an alert when disarming. The Responder HD remote control also interrupts each Status screen output and plays the **LOW BATTERY ON REMOTE** screen with several alert beeps.

### Important

To preserve power at critically low battery levels the HD remote disables the color display, stops receiving messages from the system, and only performs basic commands. The beeps and blue transmit LED continues to operate while performing basic commands until the battery is charged.

## Battery Life

The Responder HD remote control has many features that make it one of the most unique remote controls on the market today, including superior long range communication with the system. The default feature settings provide for excellent battery charge duration. However, to maximize this duration between charges, the following suggestions will help:

- Turn the remote Off: When not in use and/or out of range of the vehicle, the remote can be turned off in the [Options](#) menu.
- Set animations to Trigger only: The animations that play during commands can be turned off in the [Options](#) menu. Only the trig-

- ger message animations will play.
- Turn Paging off: The remote will not wake up to check for messages with Paging off in the [Settings](#) menu.  
**Caution!** The remote will not receive trigger messages from the system.
  - Turn Beeps off: The Button beeps can be turned off in the [Settings](#) menu. The command beeps still play normally.

## Battery Disposal



Directed Electronics cares about the environment. If you need to dispose of the battery, please do so in accordance with your municipal requirements for battery disposal.

# Glossary of Terms

---

## Document Terminology

Control Module	The “brain” of your system. Usually hidden underneath the dash area of the vehicle. It houses the microprocessor which monitors your vehicle and controls all of the system’s functions.
Responder HD (2-way Remote Control)	A hand-held, remote control which operates the various functions of your system and receives messages and pages from the system.
Companion Remote (1-way Remote Control)	A hand-held, remote control which operates the various functions of your system but does not provide message display.
Control Center	The control center contains the system’s radio-frequency antenna, the control button, and the Status LED. For maximum remote-control range, the Control Center is usually located at the top of the windshield, centered near the rear-view mirror.
Status LED	A light used to indicate the status of your system. It is located on your system’s Control Center.
Control Button	A small push button located on your system’s Control Center. It is used to override (disarm) the alarm when a remote is not available or to enter or exit Valet Mode.

# Specifications

---

## Responder HD 2-way SST Remote Control

Power Requirements:	5 VDC, 500 mA
Display:	128 by 128 pixel, 65k, Color Organic Light Emitting Diode (OLED)
Frequency:	900 - 928 MHz Spread Spectrum
Operating Temperature:	-10°C to +40°C (23°F to 104°F)

## Security with Remote Start System (in Vehicle)

Power Requirements:	11VDC - 14VDC
Siren Output:	120 dB at 1 meter
Frequency:	900 - 928 MHz Spread Spectrum
Operating Temperature:	-40°C to +85°C (-40°F to 185°F)

## 1-way SST Remote Control

Power Requirements:	3 VDC, CR2032 Coin Cell Battery
Frequency:	900 MHz
Operating Temperature:	-10°C to +40°C (23°F to 104°F)

# Government Regulations

---

This device complies with Part 15 of FCC rules. Operation is subject to the following two conditions: (1) This device may not cause harmful interference, and (2) This device must accept any interference received, including interference that may cause undesirable operation.

This equipment has been tested and found to comply with the limits for a class B digital device, pursuant to Part 15 of the FCC Rules. These limits are designed to provide reasonable protection against harmful interference in a residential installation. This equipment generates and can radiate radio frequency energy and, if not installed and used in accordance with the instruction manual, may cause harmful interference to radio communications. However, there is no guarantee that interference will not occur in a particular installation. If this equipment does cause harmful interference to radio or television, which can be determined by turning the equipment OFF and ON, the user is encouraged to try to correct the interference by one or more of the following measures:

- Reorient or relocate the receiving antenna.
- Increase the separation between the equipment and receiver.
- Connect the equipment into an outlet on a circuit different from that to which the receiver is connected.
- Consult the dealer or an experienced radio / TV technician for help.

## Remote Controls

To satisfy FCC RF exposure compliance requirements, this device should be used in hand-held, hand operated configurations only. The device and its antenna must maintain a separation distance of 20 cm or more from the person's body, except for the hand and wrists, to satisfy RF exposure compliance. This device is designed to be used in a person's hands and its operating configurations do not support normal transmissions while it is carried in pockets or holsters next to a person's body.

## Control Center

To satisfy FCC RF exposure compliance requirements, the device and its antenna must maintain a separation distance of 20 cm or more from the person's body, except for the hand and wrists, to satisfy RF exposure compliance.

This device complies with the Industry Canada Radio Standards Specification RSS 210. Its use is authorized only on a no-interference, no-protection basis; in other words, this device must not be used if it is determined that it causes harmful interference to services authorized by IC. In addition, the user of this device must accept any radio interference that may be received, even if this interference could affect the operation of the device.

**WARNING!** Changes or modifications not expressly approved by the party responsible for compliance could void the user's authority to operate this device.

## Warning! Safety First

---



Please read the safety warnings below before proceeding. Improper use of the product may be dangerous or illegal.

### Installation

Due to the complexity of this system, installation of this product must only be performed by an authorized Directed dealer. If you have any questions, ask your retailer or contact Directed directly at 1-800-753-0600.

### Remote Start Capable

When properly installed, this system can start the vehicle via a command signal from the remote control transmitter. Therefore, never operate the system in an enclosed area or partially enclosed area without ventilation (such as a garage). When parking in an enclosed or partially enclosed area or when having the vehicle serviced, the remote start system must be disabled using the installed menu wheel. It is the user's sole responsibility to properly handle and keep out of reach from children all remote control transmitters to assure that the system does not unintentionally remote start the vehicle. THE USER MUST INSTALL A CARBON MONOXIDE DETECTOR IN OR ABOUT THE LIVING AREA ADJACENT TO THE VEHICLE. ALL DOORS LEADING FROM ADJACENT LIVING AREAS TO THE ENCLOSED OR PARTIALLY ENCLOSED VEHICLE STORAGE AREA MUST AT ALL TIMES REMAIN CLOSED. These precautions are the sole responsibility of the user.

### Manual Transmission Vehicles

**Remote starters on manual transmission vehicles operate differently than those with automatic transmission** because you must leave your car in neutral. You must read this Owner's Guide to familiarize yourself with the proper procedures regarding manual transmission remote starters. If you have any questions, ask your authorized Directed dealer or contact Directed at 1-800-753-0600.

Before remote starting a manual transmission vehicle, be sure to:

- Leave the vehicle in neutral and be sure no one is standing in front or behind the vehicle.
- Only remote start on a flat surface
- Have the parking brake fully engaged

**WARNING!** It is the responsibility of the owner to ensure the parking/emergency brake properly functions. Failure to do so can result in personal injury or property damage. We recommend the owner have the parking / emergency brake system inspected and adjusted by a qualified automotive shop biannually.

Use of this product in a manner contrary to its intended mode of operation may result in property damage, personal injury, or death. (1) Never remotely start the vehicle with the vehicle in gear, and (2) Never remotely start the vehicle with the keys in the ignition. The user must also have the neutral safety feature of the vehicle periodically checked, wherein the vehicle must not remotely start while the car is in gear. This testing should be performed by an authorized Directed dealer in accordance with the Safety Check outlined in the product installation guide. If the vehicle starts in gear, cease remote start operation immediately and consult with the authorized Directed dealer to fix the problem.

After the remote start module has been installed, contact your authorized dealer to have him or her test the remote start module by performing the Safety Check outlined in the product installation guide. If the vehicle starts when performing the Neutral Safety Shutdown Circuit test, the remote start unit has not been properly installed. The remote start module must be removed or the installer must properly reinstall the remote start system so that the vehicle does not start in gear. All installations must be performed by an authorized Directed dealer.

OPERATION OF THE REMOTE START MODULE IF THE VEHICLE STARTS IN

GEAR IS CONTRARY TO ITS INTENDED MODE OF OPERATION. OPERATING THE REMOTE START SYSTEM UNDER THESE CONDITIONS MAY RESULT IN PROPERTY DAMAGE OR PERSONAL INJURY. YOU MUST IMMEDIATELY CEASE THE USE OF THE UNIT AND SEEK THE ASSISTANCE OF AN AUTHORIZED Directed DEALER TO REPAIR OR DISCONNECT THE INSTALLED REMOTE START MODULE. DIRECTED WILL NOT BE HELD RESPONSIBLE OR PAY FOR INSTALLATION OR REINSTALLATION COSTS.

This product is designed for fuel injected vehicles only. Use of this product in a standard transmission vehicle must be in strict accordance with this guide.

This product should not be installed in any convertible vehicles, soft or hard top with a manual transmission. Installation in such vehicles may pose certain risk.

## **Interference**

All radio devices are subject to interference which could affect proper performance.

## **Upgrades and Batteries**

Any upgrades to this product and/or installation of batteries must be performed by an authorized dealer. Do not attempt to perform any unauthorized modifications to this product.

## **Water/Heat Resistance**

This product is not designed to be water and/or heat-resistant. Please take care to keep this product dry and away from heat sources. Any damage from water or heat will void the warranty.

## Limited lifetime consumer warranty

---

Directed Electronics. ("Directed") promises to the original purchaser to repair or replace (at Directed's election) with a comparable reconditioned model any Directed unit (hereafter the "unit"), excluding without limitation the siren, the remote transmitters, the associated sensors and accessories, which proves to be defective in workmanship or material under reasonable use during the lifetime of the vehicle provided the following conditions are met: the unit was purchased from an authorized Directed dealer, the unit was professionally installed and serviced by an authorized Directed dealer; the unit will be professionally reinstalled in the vehicle in which it was originally installed by an authorized Directed dealer; and the unit is returned to Directed, shipping prepaid with a legible copy of the bill of sale or other dated proof of purchase bearing the following information: consumer's name, telephone number and address; the authorized dealers name, telephone number and address; complete product description, including accessories; the year, make and model of the vehicle; vehicle license number and vehicle identification number. All components other than the unit, including without limitation the siren, the remote transmitters and the associated sensors and accessories, carry a one-year warranty from the date of purchase of the same. ALL PRODUCTS RECEIVED BY DIRECTED FOR WARRANTY REPAIR WITHOUT PROOF OF PURCHASE FROM AN AUTHORIZED DEALER WILL BE DENIED. This warranty is non-transferable and is automatically void if: the unit's date code or serial number is defaced, missing or altered; the unit has been modified or used in a manner contrary to its intended purpose; the unit has been damaged by accident, unreasonable use, neglect, improper service, installation or other causes not arising out of defects in materials or construction. The warranty does not cover damage to the unit caused by installation or removal of the unit. Directed, in its sole discretion, will determine what constitutes excessive damage and may refuse the return of any unit with excessive damage. TO THE MAXIMUM EXTENT ALLOWED BY LAW, ALL WARRANTIES, INCLUDING BUT NOT LIMITED TO EXPRESS WARRANTY, IMPLIED WARRANTY, WARRANTY OF MERCHANTABILITY, FITNESS FOR PARTICULAR PURPOSE AND WARRANTY OF NON-INFRINGEMENT OF INTELLECTUAL PROPERTY, ARE EXPRESSLY EXCLUDED; AND DIRECTED NEITHER ASSUMES NOR AUTHORIZES ANY PERSON OR ENTITY TO ASSUME FOR IT ANY DUTY, OBLIGATION OR LIABILITY IN CONNECTION WITH ITS PRODUCTS. DIRECTED DISCLAIMS AND HAS ABSOLUTELY NO LIABILITY FOR ANY AND ALL ACTS OF THIRD PARTIES INCLUDING ITS AUTHORIZED DEALERS OR INSTALLERS. DIRECTED SECURITY SYSTEMS, INCLUDING THIS UNIT, ARE DETERRENTS AGAINST POSSIBLE THEFT. DIRECTED IS NOT OFFERING A GUARANTEE OR INSURANCE AGAINST VANDALISM, DAMAGE OR THEFT OF THE AUTOMOBILE, ITS PARTS OR CONTENTS; AND HEREBY EXPRESSLY DISCLAIMS ANY LIABILITY WHATSOEVER, INCLUDING WITHOUT LIMITATION, LIABILITY FOR THEFT, DAMAGE AND/OR VANDALISM. THIS WARRANTY DOES NOT COVER LABOR COSTS FOR MAINTENANCE, REMOVAL OR REINSTALLATION OF THE UNIT OR

ANY CONSEQUENTIAL DAMAGES OF ANY KIND. IN THE EVENT OF A CLAIM OR A DISPUTE INVOLVING DIRECTED OR ITS SUBSIDIARY, THE VENUE SHALL BE SAN DIEGO COUNTY IN THE STATE OF CALIFORNIA. CALIFORNIA STATE LAWS AND APPLICABLE FEDERAL LAWS SHALL APPLY AND GOVERN THE DISPUTE. THE MAXIMUM RECOVERY UNDER ANY CLAIM AGAINST DIRECTED SHALL BE STRICTLY LIMITED TO THE AUTHORIZED DIRECTED DEALER'S PURCHASE PRICE OF THE UNIT. DIRECTED SHALL NOT BE RESPONSIBLE FOR ANY DAMAGES WHATSOEVER, INCLUDING BUT NOT LIMITED TO, ANY CONSEQUENTIAL DAMAGES, INCIDENTAL DAMAGES, DAMAGE TO VEHICLE, DAMAGES FOR THE LOSS OF TIME, LOSS OF EARNINGS, COMMERCIAL LOSS, LOSS OF ECONOMIC OPPORTUNITY AND THE LIKE. NOTWITHSTANDING THE ABOVE, THE MANUFACTURER DOES OFFER A LIMITED WARRANTY TO REPLACE OR REPAIR THE CONTROL MODULE SUBJECT TO THE CONDITIONS AS DESCRIBED HEREIN. THIS WARRANTY IS VOID IF THE UNIT HAS NOT BEEN PURCHASED FROM DIRECTED, OR AN AUTHORIZED DIRECTED DEALER, OR IF THE UNIT HAS BEEN DAMAGED BY ACCIDENT, UNREASONABLE USE, NEGLIGENCE, ACTS OF GOD, NEGLIGENCE, IMPROPER SERVICE, OR OTHER CAUSES NOT ARISING OUT OF DEFECT IN MATERIALS OR CONSTRUCTION.

Some states do not allow limitations on how long an implied warranty will last or the exclusion or limitation of incidental or consequential damages. This warranty gives you specific legal rights and you may also have other rights that vary from State to State.

This warranty is only valid for sale of product(s) within the United States of America and in Canada. Product(s) sold outside of the United States of America or Canada are sold "AS-IS" and shall have NO WARRANTY, express or implied.

For further details relating to warranty information of Directed products, please visit the support section of Directed's website at: [www.directed.com](http://www.directed.com)

This product may be covered by a Guaranteed Protection Plan ("GPP"). See your authorized Directed dealer for details of the plan or call Directed Customer Service at 1-800-876-0800.

920-10011-01 2011-06