



Vista, CA 92081  
www.pythoncarsecurity.com

**The company behind Python® Auto Security Systems  
is Directed Electronics.**

Since its inception, Directed Electronics has had one purpose, to provide consumers with the finest vehicle security and car stereo products and accessories available. The recipient of nearly 100 patents and Innovations Awards in the field of advanced electronic technology, Directed Electronics is ISO 9001 registered.

Quality Directed Electronics products are sold and serviced throughout North America and around the world.

Call **(800) 876-0800** for more information about our products and services.

© 2009 Directed Electronics. All rights reserved.

G3203P 2009-11



**PYTHON**  
SECURITY FOR THE BEST®



Directed Electronics is an  
ISO 9001 registered company.

Directed Electronics is committed to delivering world class quality products and services that excite and delight our customers.

**OWNER'S GUIDE**

**M O D E L  
323**

# Congratulations

---

Congratulations on the purchase of your state-of-the-art security system. Reading this owner's guide prior to using your system will help maximize the use of your system and its many features. For more information please visit the below website:

<http://www.pythoncarsecurity.com> – For general and additional guide information.

For any additional questions please contact your authorized Directed dealer or contact Directed at **1-800-753-0600**.

## What you get

---

Welcome to the best generation of vehicle security. Your system contains everything you need.

- Responder LE remote control
- 1-way companion remote control
- This owner's guide
- Quick reference card
- Warranty card

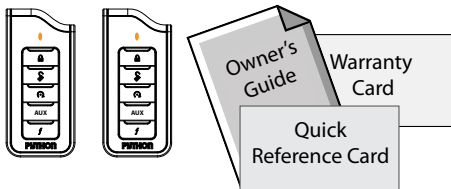

# Important information

---

## Your Warranty

Your system comes with a warranty. Please make sure you receive the warranty registration card and proof of purchase from your dealer indicating the product was installed by an authorized Directed dealer. Your product warranty must be validated within 10 days of purchase. You can validate it online at [www.prodregister.com/directed](http://www.prodregister.com/directed) or complete and return the warranty registration card.

## Quick Reference Card

Carry this card with you to reference your system's many features.

## Replacement Remote Controls

If additional remote controls are desired, please see your authorized dealer or visit us at [www.directedstore.com](http://www.directedstore.com) to order. Part numbers are: 7251P for Responder LE 2-way remote control and 7153P for the 1-way companion remote control.

# Contents

---

Getting Started.....	3
Keys to using this manual.....	3
Responder LE 2-Way.....	4
Using your System.....	6
Commands and Confirmations.....	6
Performing Commands.....	6
Remote Control Command table.....	7
Basic Commands (Direct Access).....	8
Arm.....	8
Disarm.....	8
Remote Start /AUX1/AUX4.....	9
AUX/Trunk.....	9
Advanced Commands: (Level 1).....	10
Silent Arm.....	10
AUX 1.....	10
Advanced Commands: (Level 2).....	11
Sensor Bypass.....	11
Remote Valet.....	11
AUX 2.....	12
Arm Status.....	12
Advanced Commands: (Level 3).....	13
Sensor Silent Arm*.....	13
AUX 3.....	13
Advanced Commands: (Level 4).....	14
Full Silent Arm*.....	14
AUX 4.....	14
Remote Control Configuration.....	15
Remote Programming.....	15
Pairing a 1-way or 2-way remote control.....	15
Remote Features.....	16
Car 2.....	18
Remote Beep.....	19
Sensor Adjust.....	19
Alarm Features.....	20
Normal Arm Protection.....	20
Sensor Silent Arm protection.....	20
Full Silent Arm Protection.....	21
Sensor Warn-away.....	21
Full Trigger.....	21
Emergency Override.....	21

Trigger Zone Fault Report.....	22
Alarm Report.....	22
Nuisance Prevention (NPC).....	23
Remote and System Operations.....	24
Passive Arming*.....	24
Auto Re-arming*.....	24
Valet Mode.....	25
Power Save.....	25
Rapid Resume.....	25
Automatic Remote Updates.....	25
Out of Range.....	26
No Remote Output.....	26
Car Select.....	26
Vehicle Recovery System (VRS).....	27
System Expansion Options.....	28
Battery Information.....	30
Low Battery.....	30
Battery Life.....	30
Battery Disposal.....	32
Glossary of Terms.....	33
Government Regulations.....	34
Additional Information.....	35
Interference.....	35
Upgrades.....	35
Water/Heat Resistance.....	35
Limited lifetime consumer warranty.....	36

# Getting Started

---

## Keys to using this manual

Specific actions (in bold type) and style conventions are used consistently throughout this manual, they are as follows:

- **Press:** implies pushing in and releasing a button.
- **Hold:** is used after “press” actions when a button needs to be held in position for an extended period of time, typically several seconds.
- *Italicized* words denote section/sub headings in this guide and can be located through the table of contents.
- An asterisk (\*) when used after a word or phrase denotes that additional details can be found in related sections usually noted at the bottom of the page or end of the section.
- Ghost LED's are identified by the command/function button they are associated with.

# Responder LE 2-Way

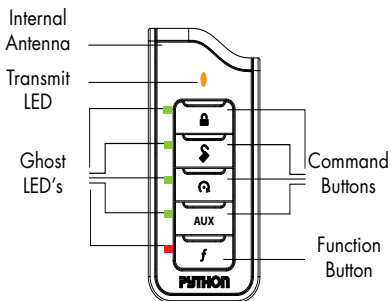

Feature	Description
Internal Antenna	Used for transmitting and receiving* information
Command Buttons (4)	Used to perform arming, disarming, and auxiliary channel commands.
Function Button	Used to access function levels for commands, configuration menus for programming, and car selection.
Ghost LED's **	Each button has an associated LED next to it that are active during related operations. These LED's are labeled respectively as: arm LED, disarm LED, rs/aux LED, aux LED, and <b>f</b> LED

- \* 2-way communication is only applicable to the Responder LE remote control
- \*\* Term denotes that these LED's are only visible when on (Ghost LED's are only applicable to the Responder LE remote control).

## Control Center

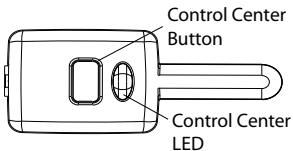

The control center, typically located on the upper part of the front windshield sends and receives commands or messages to and from your system. It consists of:

- The In-vehicle system antenna, for 2 way communication.
- The control center LED, as a visual indicator of the system's status.
- The control center button, for placing the system into valet mode\* and to perform the emergency override\*\* operation.

\* See *Remote and System Operations* section for details.

\*\* See *Alarm Features* for details.



# Using your System

---

## Commands and Confirmations

Commands, basic or advanced, are used to activate system features and are performed by pressing one of the command buttons. Basic commands control the most often used security features while advanced commands control more specialized features.

Confirmations for basic or advanced commands are indicated first by siren chirps and parking light flashes, and then by illuminated Ghost LED's and beeps or tones on the remote control. A description of each feature confirmation is found in the *Basic Commands* and *Advanced Commands* sections.

## Performing Commands



Perform basic commands by pressing a command button (Ghost LED's are off).

Perform advanced commands by first accessing Levels 1-4 using the **f** button and then by pressing a command button while within a Level (Levels are indicated by illuminated ghost LED's after pressing **f** button).

### Advanced Command example: Silent Arm

1. **Press** the **f** button once to access function level 1, the **f** LED turns on.
2. **Press** the  button while the **f** LED is still on to perform the silent arm command.
3. The Arm LED will illuminate to confirm when the silent arm message from the system is received.

## Remote Control Command table

Level Button	Direct Access	<b>f</b> x 1 LEVEL 1	<b>f</b> x 2 LEVEL 2	<b>f</b> x 3 LEVEL 3	<b>f</b> x 4 LEVEL 4
	Arm/Lock (Panic)	Silent Arm	Sensor Bypass	Sensor Silent Arm	Full Silent Arm
	Disarm/Unlock	Silent Disarm	Remote Valet	Car Finder	
	Remote Start* / Aux 1/4**				
<b>AUX</b>	Aux/Trunk	AUX 1	AUX 2	AUX 3	AUX 4
<b>f</b>	Advance Level, Change Car (3 sec), Enter programming (8 sec)		Arm Status ***		

- \* Available only with optional remote start module installation
- \*\* This button can command either aux 1 or aux 4 if turned on by an authorized Directed dealer.
- \*\*\* Not available for the 1-way companion remote control.

# Basic Commands (Direct Access)

---

No ghost LED's on

## Arm



Press and release 

The alarm arms, doors lock (if connected), and the siren chirps and parking lights flash once. The arm LED and beeps play to confirm. If valet mode\* is on, the doors lock and the arm LED, **f** LED and a fault tone plays. Exit valet mode to arm the alarm normally.

If a trigger zone fault is detected the siren chirps once again and the remote will emit a trigger zone fault report\*\*\*, the arm LED, **f** LED and a fault tone plays.

## To Arm and Panic

Press and hold 

The alarm arms (or locks in valet) and, after 2 seconds, sounds the siren and flashes the parking lights. The ghost LED's flash and siren tones play to confirm. Press the  or  button to stop the output.

## Disarm

Press and release 

The alarm disarms, doors unlock (if connected), and the siren chirps and parking lights flash twice. The disarm LED and beeps play to confirm. If valet mode\* is on, the doors unlock and the disarm LED, **f** LED and fault tones play.

An alarm report\*\* will replace the disarm output if the alarm was triggered; the siren will chirp 4 or 5 times, and the disarm LED, **f** LED and 4 or 5 fault tones play to alert of the report.

## Remote Start /AUX1/AUX4

Press and release 

### Remote Start\*\*\*

Activates (or if on, deactivates) the remote starter. The engine and parking lights turn on or off accordingly. The rs/aux LED and on tones play, or the rs/aux LED and off tones play to confirm.

### AUX1/AUX4\*\*\*\*

Activates (or if on, deactivates) the aux 1 or aux 4 output. The aux LED and on tones or off tones play to confirm.

## AUX/Trunk

Press and hold **AUX**

The Trunk opens (if connected) when this button is pressed for 2 seconds. The Aux LED and tones play to confirm.

\* See *Remote and System Operations* for details.

\*\* See *Alarm Features* for details.

\*\*\* Available only with optional Remote Start module installation.

\*\*\*\* This feature must be turned on by an authorized Directed dealer.

## Advanced Commands: (Level 1)

---

Press and release the **f** button 1 time. The **f** LED illuminates indicating Level 1

**Note:** The transmit LED on the 1-way remote will flash in groups of 1 to indicate level 1.

### Silent Arm

Press and release 

The alarm arms, doors lock (if connected), and the parking lights flash once. The arm LED turns on to confirm. valet mode\* or trigger zone fault report\*\* messages may be received.

### Silent Disarm

Press and release 

The alarm disarms, doors unlock (if connected), and the parking lights flash twice. The disarm LED turns on to confirm. The silent disarm output may be replaced by the alarm report\*\*.

### AUX 1

Press and release **AUX**

Activates (or if on, deactivates) the aux 1 output. The aux LED and on tones or off tones play to confirm.

\* See *Remote and System Operations* section for details.

\*\* See *Alarm Features* for details.

## Advanced Commands: (Level 2)

Press and release the **f** button 2 times. The **f** and aux LED's illuminate indicating Level 2

**Note:** The transmit LED on the 1-way remote will flash in groups of 2 to indicate level 2.

### Sensor Bypass

Press and release 

Performing the sensor bypass command will incrementally bypass sensor operations and be confirmed as follows:

- **Warn-away Bypass:** The parking lights flash 2 times. The arm LED, 1 beep and 1 fault tone play to confirm. Sensors will be activated for full trigger levels of impact only.
- **Warn-away & Full Trigger Bypass:** The parking lights flash 3 times. The arm LED, 1 beep and 2 fault tones play to confirm. Sensors will not be activated for any level of impact.
- **Sensor Bypass Off:** The parking lights flash 1 time. The arm LED and 1 beep play to confirm. Sensors are fully operational.

<b>Note</b>	Sensor bypass can only be performed when the system is armed. The <b>f</b> LED and a long fault tone plays as an alert when performing sensor bypass when the system is disarmed. Perform arm command any time to turn sensor bypass off.
-------------	---

### Remote Valet

Press and release 

Enters (or if on, exits) valet mode. The control center LED turns on and

off accordingly. The disarm LED and valet beeps play (1 for on, 2 for off) to confirm.

## **AUX 2**

**Press** and release **AUX**

Activates (or if on, deactivates) the aux 2 output. The aux LED and on tones or off tones play to confirm.

## **Arm Status**

**Press** and **hold** the **f** button

The remote will generate an output to display the systems arm status since its last update message or command operation. It will report status via ghost LED's, beeps, and tones as described in this section for arm, disarm, valet mode arm, valet mode disarm, sensor silent arm, full silent arm.

## Advanced Commands: (Level 3)

---

Press and release the **f** button 3 times. The **f**, aux and rs/aux LED's illuminate indicating Level 3.

**Note:** The transmit LED on the 1-way remote will flash in groups of 3 to indicate level 3.

### Sensor Silent Arm\*

Press and release 

The alarm arms, doors lock, and the siren chirps and parking lights flash 3 times. The arm LED, 1 beep and 3 fault tones play to confirm.

### Car finder

Press and release 

The siren emits one long chirp and the parking lights flash for 10 seconds. The disarm LED and 1 beep play to confirm. The parking light flashes stop if armed or disarmed while car finder is in progress.

### AUX 3

Press and release **AUX**

Activates (or if on, deactivates) the aux 3 output. The aux LED and on tones or off tones play to confirm.

\* See *Alarm Features* for more details.



## Advanced Commands: (Level 4)

---

Press and release the **f** button 4 times. The **f**, aux, rs/aux and disarm LED's illuminate indicating Level 4

**Note:** The transmit LED on the 1-way remote will flash in groups of 4 to indicate level 4.

### Full Silent Arm\*

Press and release 

The alarm arms, doors lock, and the siren chirps and parking lights flash 4 times. The arm LED, 1 beep and 4 fault tones play to confirm.

### AUX 4

Press and release **AUX**

Activates (or if on, deactivates) the aux 4 output. The aux LED and on tones or off tones play to confirm.

\* See *Alarm Features* for more details.

# Remote Control Configuration

---

## Remote Programming

The Responder LE and 1-way companion remote controls have operations that can be configured to a user's personal preferences. The following instruction will direct you through the available programming options for both remote controls.

To enter programming, **press** and **hold** the **f** button for 8 seconds, the remote emits one long beep and the transmit LED turns on to indicate the main menu is accessed.

To exit programming or go back to a previous menu, **press** and release the **f** button. 1 short and 1 long beep is emitted for each step back and when programming is exited the transmit LED turns off.

**Note:** The 1 way remote does not emit any confirmation beeps.

## Pairing a 1-way or 2-way remote control

**Note:** The remote control may or may not emit sounds during this operation.



### Prepare the vehicle

1. **Open** a door.
2. **Turn** the ignition On.
3. **Press** and **release** then **press** and **hold** the control center button. The control center LED flashes and siren chirps one time to confirm the system is prepared.
4. **Release** the button and proceed below.

**Note:** Begin pairing within 60 seconds or the system will exit (indicated by a long siren chirp) and need to be prepared again.

## Prepare the remote control

Select the desired car 1 (default) or car 2 operation before proceeding.

1. **Press and hold** the **f** button of the remote control for 8 seconds until the transmit LED turns on, and then release it (If programmed to operate two systems, ignore the Transmit LED flashes at 3 seconds).
2. **Press and hold** the  button until the transmit LED flashes off and on three times.
3. **Press and hold** the  button until the siren emits one long chirp to confirm Pairing.



**Note:** 2-way remote controls MUST also emit a sequence of chimes to confirm pairing is successful. If not heard, make sure the system is still prepared and repeat step 3 until successful.

## Remote Features

**Press** the  button to access the remote operation features, 2 transmit LED flashes and 2 beeps indicate the remote features menu is accessed. **Press** the buttons indicated in the tables below to set the feature option.

### Responder LE



The ghost LED's next to the button indicate the feature settings.

Feature	Button Press	LED on	LED off	LED Flash	LED Double Flash
Keypad Lock		Auto	Off		
Remote Beeps		Beeps On	Beeps Off	Triggers only	
Car 2		Car 2 On	Car 2 Off		

Feature	Button Press	LED on	LED off	LED Flash	LED Double Flash
Page Mode	<b>AUX</b>	Paging On	Paging Off	Power Save 1	Power Save 2

## 1-way companion remote control

The 1-way remote will flash the transmit LED to indicate the setting.

Feature	Button Press	LED on	LED off
Keypad Lock		Auto	Off
No function		No function	No function
Car 2		Car 2 On	Car 2 Off

## Keypad Lock

Options: Off, Auto

When off, the buttons do not lock and always perform a command when pressed. When set to auto, the remote buttons lock after a 20 second lapse between buttons presses to prevent unintentional operations. If a button is pressed when locked the **f** LED and a fault tone play as an alert.

To unlock the buttons, press the **f** button followed by the  button. The ghost LEDs flash and tones play to confirm unlocking.

**Note:** When the 1-way remote keypad is locked, the remote control appears to be non-operational. It will not transmit a command or illuminate the transmit LED and needs to be unlocked to resume normal operation.

## Auto unlocking

After turning the ignition off, a message to the Responder LE will unlock the keypad buttons until the next command is performed. If auto unlocking is not desired this message can be turned off by an authorized Directed dealer.

## Page Mode

Options: Power Save 1, Power Save 2, On, Off

Paging is how the Responder LE remote monitors your system's messages. Power save extends battery life by turning paging off after 72 hours if the remote control is not used during this period. Just press any button to resume system monitoring. Power save 2 is for maximum battery life and will monitor the system only when remote start has been activated. **Caution:** Use only with an optional remote start module connected. Alarm trigger messages will not be received when remote start is off. When set to on it wakes up every few seconds to listen for pages from the system. When set to off it does not wake up to receive alarm trigger pages.

Note: When off, responses are still received when a command is performed but alarm trigger pages will not be received.

## Car 2

Options: Off, On

The Responder LE and 1-way companion remote controls can control two systems independently. When set to off, the car select feature is not available. When set to on the car select feature is enabled. See *Car Select* (under *Remote and System Operations*) for details on using a remote with 2 systems.

## Remote Beep

Options: On, Off, Triggers Only

The Responder LE will emit a beep as confirmation of button presses and command responses. When set to off, beeps are not emitted for any operations except programming. For triggers only, beeps will only be emitted for full trigger messages.

## Sensor Adjust

The  button is used for sensor adjustment, to avoid unintended alarm triggers; it is recommended that an authorized Directed dealer performs all sensor adjustments.

# Alarm Features

---

## Normal Arm Protection

**Control center LED:** The control center LED flashes as a visual indicator that your vehicle's security system is active.

**Starter Kill:** The Failsafe starter kill relay prevents the engine from starting

**Note** May require additional parts and installation

**Sensor triggers:** The onboard shock sensor can distinguish minor impacts from major impacts to the vehicle exterior. Minor impacts causes the system to emit a Warn-away output by chirping the siren and flashing the parking lights for 3 seconds. Major impacts caused for example by a forcible entry attempt, results in a Full Trigger output. The siren sounds and the parking lights flash for 30 seconds or longer. Full Triggers send a message to the remote control.

**Point of entry triggers:** Opening the hood or trunk causes a Full Trigger output, while opening a Door or turning on the Ignition causes the the siren to chirp 3 seconds before beginning the Full Trigger output. This 3 second delay allows time to disarm and silence the siren in case of accidental trigger. The Full Trigger message is still sent to the remote.

## Sensor Silent Arm protection

Sensor Warn-away and Sensor Full Trigger activations only send messages to the Responder LE remote control, while the parking light flash and siren outputs are defeated. Point of entry triggers will activate the parking light flash, siren, and send messages normally.

## Full Silent Arm Protection

Sensor Warn-away, Sensor Full Trigger and Point of Entry activations will only send messages to the Responder LE remote control, with parking light flash and siren outputs defeated.

## Sensor Warn-away

When the system sensors detect a Warn-away trigger the siren chirps and parking lights flash for 3 seconds. No messages are sent to the Responder LE remote control for Warn-away triggers.

## Full Trigger

An alarm Full Trigger will sound the siren and flash the parking lights for 30 seconds while sending a Full Trigger message to the remote control. The ghost LED's flash and siren tones play for 30 seconds followed by an alert that consists of 1 long beep per minute for 10 minutes.

To stop the output and alert, **press** a command button to perform a command, or **Press** the **f** button.

## Emergency Override

The following procedure disarms the system when a programmed remote is not available. Number of presses \_\_\_\_\_

1. **Turn** the ignition On.
2. **Press** the control button on the Control Center the correct number of times (the default is 1 press).
3. After a few seconds the siren output ceases and the system is disarmed.

### Note

As a precaution, if programmed for Passive Arming or Auto re-arming the system should be placed into Valet Mode until a remote is available .



## Trigger Zone Fault Report

When armed by remote command the system runs a status check of the alarm trigger zones. Faulty zones (usually caused by dome light delay or open trunk) are bypassed and reported via the control center LED and remote, while all other trigger zones remain active and are monitored to protect the vehicle. Should a faulty zone self correct (dome light turns off) it becomes active and is then monitored normally.

The siren chirps once again a few seconds following the arming chirps as an audible alert, the control center LED flashes in groups to indicate the zone number.

## Alarm Report

If the alarm was triggered while armed, it will be reported when the alarm is disarmed via the remote control, siren chirps, parking light and control center LED flashes. The siren chirps 4 times (or 5 times if NPC On\*), the parking lights flash 3 times, and the control center LED flashes in groups to indicate the last two zones that were triggered (see Table of Zones). The report output will repeat for each disarm operation until the ignition is turned on.

\* See *Nuisance Prevention (NPC)* for more details.

Table of Zones

Zone # (led flashes)	Zone Name
1	Trunk
2	Shock Sensor
3	Door
4	Sensor 2
5	Ignition
6	Hood
7	Sensor 3

## Nuisance Prevention (NPC)

NPC monitors all alarm zones and, if any are triggered excessively, bypasses them until corrected. If a point of entry (trunk, hood, door) is left open following a forced entry, it is bypassed. It becomes active again only after being closed.

Bypassed sensors automatically reset after one hour and after the vehicle is driven. Disarming then re-arming the alarm does not reset bypassed sensors.

# Remote and System Operations

---

## Passive Arming\*

Park and exit the vehicle, after the doors are closed the Passive arming countdown begins. The control center LED flashes quickly and upon reaching 20 seconds the siren then chirps once. At 30 seconds the system arms itself.

Anytime before the system arms you can re-enter the vehicle or open the trunk to load or unload items and, after closing passive arming resumes.

To stay secure in case of accidental disarming of the system, if a door is not opened within 30 seconds the system re-arms itself and locks the doors.

## Auto Re-arming\*

Auto re-arm ensures the vehicle stays protected if it is not entered after disarming by remote control. After disarming by remote, the alarm automatically re-arms itself (and locks the doors if programmed on) in 30 seconds. Open any point of entry to stop the re-arm until the next disarm by remote.

## Onetime Bypass\*

**Turn** the ignition on for one to three seconds and then off. The siren chirps once to confirm one-time bypass is enabled.

One-time bypass can be used to temporarily bypass the Passive arming operation for one cycle. It also bypasses the comfort closure and auxiliary channel outputs programmed to activate when arming. After the next disarm all operations return to normal.

\* These features must be turned on by an authorized Directed dealer.

## Valet Mode

Valet mode can be entered and exited by performing the remote valet command or manually using the vehicle key and the control button. When entered, the alarm functions are defeated while the convenience features still operate normally.

Arm and disarm commands lock and unlock the doors. The Responder LE emits the arm in valet and disarm in valet output as described for arm and disarm in the *Basic Commands* section.

Use the following steps to manually enter and exit valet mode:

1. **Turn** the ignition switch on and then off
2. Immediately **press** and **release** the control button once
3. The control center LED turns on when entering and off when exiting.

## Power Save

To reduce power consumption the control center LED modifies its output if the vehicle is parked for an extended period. If armed, the flashing is reduced after 24 hours. When valet mode is on the control center LED will turn off after 1 hour and will reset each time the ignition is turned off.

## Rapid Resume

If power is ever disconnected by a mechanic or thief, the system will resume the state it was in at the time of disconnection, when power is reconnected.

## Automatic Remote Updates

The system sends a silent message to all remote controls after any major action has occurred. When the remote receives this message it updates the arm status.

## Out of Range

Each time a command is performed the Responder LE will expect a command confirmation from the system. If a command confirmation is not received the **f** and transmit LED's flash and a long fault tone plays as an alert.

## No Remote Output

Occasionally when a command is performed the remote may not generate a command confirmation output or out of range output. This indicates that the system received the command but it was an incomplete command (e.g. aux button pressed too short to activate the trunk release) or it was an illegal message (e.g. the command was corrupted due to local RF interference). These are temporary normal functions of the system and remote, perform the command again within 10 seconds to return to normal operation.

## Car Select

Car 2 must first be turned on (See *Remote Control Configuration* section to turn on).

1. **Press** and **hold** the **f** button for 3 seconds. The remote flashes the transmit LED and beeps once or twice to indicate the selected car is 1 or 2.
2. **Release** the **f** button, then **press** and **release** while the transmit LED and beeps continue to perform car select. Once the car is selected a command can be performed by pressing one of the command buttons.

**Note:** The 1-way remote does not emit any indication beeps. The transmit LED flashes once or twice to indicate car one or car two.

## Vehicle Recovery System (VRS)

In case your vehicle is stolen or carjacked, VRS sounds the siren and flashes the parking lights to persuade the thief to abandon the vehicle, and when the ignition is turned off, activates the starter kill to prevent the engine from restarting.

To arm VRS, perform the silent arm command while driving, or while the ignition is turned on. The siren chirps and parking lights flash once to confirm arming. The arm LED and beeps play to confirm arming.

If valet mode is on, the **f** LED and fault tone plays, exit valet mode before arming VRS.

Once armed, VRS triggers if any door is opened then closed while the ignition remains on, and if the vehicle is parked while armed, VRS triggers when driving resumes. See trigger description below.

When triggered, the control center LED begins flashing after fifteen seconds. Within 45 seconds perform the silent arm command to disarm VRS. If not disarmed, the siren begins chirping for 60 seconds and then becomes a constant siren blast with flashing parking lights for several minutes. This output will continue and be repeated each time the ignition is turned on until VRS is disarmed.

To disarm, perform the silent disarm command anytime before VRS has been triggered, or within one minute after it has triggered and before the siren begins to chirp. If not disarmed before the siren begins to chirp, the emergency override procedure must be used to disarm VRS.

# System Expansion Options

---

## Controlling Two Vehicles (Car Select)

The Responder LE and 1way companion remote can control systems in two different vehicles saving the need for multiple remote controls. This feature also allows for customized system configurations on each vehicle that has more than one driver. See following *Owner Recognition* for details.

## Owner Recognition

The system can be configured to recognize the remote used when disarming and change selected features to match the remote users preferences. Memory seat adjustment, siren chirps, passive arming, remote button auto unlocking, alarm output duration can all be custom set for each remote user at the time of installation.

## Comfort Closure

Comfort closure emulates turning the key in the door cylinder or holding the lock button of an OEM keyless entry. It will automatically close the windows and sunroof on vehicles with this type of OEM convenience feature.

## Alarm Output Duration

The length of time the siren sounds can be adjusted from 1 to 180 seconds at the time of installation.

## Arming and Warn-away Chirp Control

The system arm, disarm and sensor warn-away chirps can be configured for those that prefer a custom silent alarm operation.

## Driver Door Priority Unlocking

The door unlocking operation can be configured to emulate an OEM style of driver priority unlocking for added security during disarming.



# Battery Information

---

The Responder LE remote is powered by 2 batteries (PN CR-2016) and the 1-way companion remote by 1 battery (PN CR-2032), that can be purchased at most retailers. When the battery begins to weaken, the operating range will be reduced. The information and precautions in this section can help maximize your battery's life and usage in providing your Responder LE and 1-way companion remote controls with many years of trouble free operation.

## Low Battery

After a command is performed the Responder LE and 1 way companion remote controls check their battery level and, when the level requires attention, will begin generating alerts. Once the alerts begin, the remote controls will remain operational for several days but the battery/batteries should be replaced at the earliest opportunity or failure to control the system may occur.

### Low Battery Alerts

When disarming the system using a remote with a low battery the siren will emit one additional chirp as an alert. If confirmation chirps are programmed off, the system will still emit one chirp as an alert when disarming. After performing a command, several beeps play on the Responder LE remote to indicate the battery/batteries need replacing.

## Battery Life

The Responder LE remote control has many features that make it one of the most unique remote controls on the market today. The default feature settings provide for excellent battery life. However, to maximize this battery life, the following suggestions will help:

- Turn Paging off: The remote will not wake up to check for messages with paging off in the setup remote menu.  
**Note:** The remote will not receive trigger messages from the system.
- Turn Beeps off: The button beeps can be turned off in the setup remote menu. The command beeps still play normally.

## Responder LE Battery Replacement

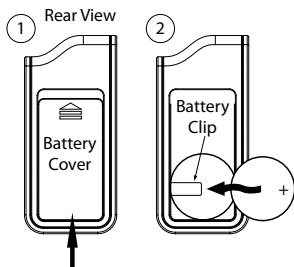

1. Slide the battery cover up by applying equal pressure at its top and bottom (the arrow on the cover indicates the direction), remove the cover from the remote control housing.

2. Gently pry up on the battery (or batteries) to remove it from the holder. Insert a new battery (or batteries) into the holder and under the clip with the positive (+) side up. Replace the battery cover. The remote control is now ready for use.

the holder and under the clip with the positive (+) side up. Replace the battery cover. The remote control is now ready for use.

## 1-way Battery Replacement

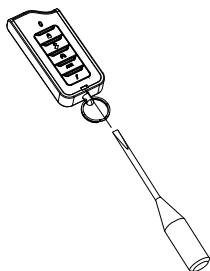

1. Using a small flathead screwdriver, insert into slot located at the bottom of the keypad and carefully pry the front of the unit open.

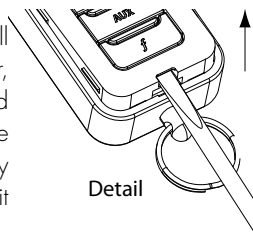



2. Turn both the unit front and circuit board over, remove battery from clip and replace while observing the correct polarity.

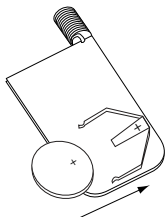

3. With the front and circuit board still turned over, turn back portion of unit onto both parts, reposition all parts and snap together.

## Battery Disposal



Directed Electronics cares about the environment. If you need to dispose of the battery, please do so in accordance with your municipal requirements for battery disposal.

# Glossary of Terms

---

## Document Terminology

Control Module	The “brain” of your system. Usually hidden underneath the dash area of the vehicle. It houses the microprocessor which monitors your vehicle and controls all of the system’s functions.
Responder LE (2-way Remote Control)	A hand-held, remote control which operates the various functions of your system and receives messages and pages from the system.
Companion Remote (1-way Remote Control)	A hand-held, remote control which operates the various functions of your system but does not provide message display.
Control Center	The control center contains the system’s radio-frequency antenna, the control center button and LED. For maximum remote-control range, the control center is usually located at the top of the windshield, centered near the rear-view mirror.
Control Center LED	A light used to indicate the status of your system. It is located on your system’s control center.
Control Center Button	A small push button located on your system’s control center. It is used to override (disarm) the alarm when a remote is not available or to enter or exit valet mode.

# Government Regulations

---

This device complies with Part 15 of FCC rules. Operation is subject to the following two conditions: (1) This device may not cause harmful interference, and (2) This device must accept any interference received, including interference that may cause undesirable operation.

This equipment has been tested and found to comply with the limits for a class B digital device, pursuant to Part 15 of the FCC Rules. These limits are designed to provide reasonable protection against harmful interference in a residential installation. This equipment generates and can radiate radio frequency energy and, if not installed and used in accordance with the instruction manual, may cause harmful interference to radio communications. However, there is no guarantee that interference will not occur in a particular installation. If this equipment does cause harmful interference to radio or television, which can be determined by turning the equipment OFF and ON, the user is encouraged to try to correct the interference by one or more of the following measures:

- Reorient or relocate the receiving antenna.
- Increase the separation between the equipment and receiver.
- Connect the equipment into an outlet on a circuit different from that to which the receiver is connected.
- Consult the dealer or an experienced radio / TV technician for help.

This device complies with the Industry Canada Radio Standards Specification RSS 210. Its use is authorized only on a no-interference, no-protection basis; in other words, this device must not be used if it is determined that it causes harmful interference to services authorized by IC. In addition, the user of this device must accept any radio interference that may be received, even if this interference could affect the operation of the device.

**WARNING!** Changes or modifications not expressly approved by the party responsible for compliance could void the user's authority to operate this device.

# Additional Information

---

## **Interference**

All radio devices are subject to interference which could affect proper performance.

## **Upgrades**

Any upgrades to this product must be performed by an authorized Directed dealer. Do not attempt to perform any unauthorized modifications to this product.

## **Water/Heat Resistance**

This product is not designed to be water and/or heat-resistant. Please take care to keep this product dry and away from heat sources. Any damage from water or heat will void the warranty.

## Limited lifetime consumer warranty

---

Directed Electronics. ("Directed") promises to the original purchaser to repair or replace (at Directed's election) with a comparable reconditioned model any Directed unit (hereafter the "unit"), excluding without limitation the siren, the remote transmitters, the associated sensors and accessories, which proves to be defective in workmanship or material under reasonable use during the lifetime of the vehicle provided the following conditions are met: the unit was purchased from an authorized Directed dealer, the unit was professionally installed and serviced by an authorized Directed dealer; the unit will be professionally reinstalled in the vehicle in which it was originally installed by an authorized Directed dealer; and the unit is returned to Directed, shipping prepaid with a legible copy of the bill of sale or other dated proof of purchase bearing the following information: consumer's name, telephone number and address; the authorized dealers name, telephone number and address; complete product description, including accessories; the year, make and model of the vehicle; vehicle license number and vehicle identification number. All components other than the unit, including without limitation the siren, the remote transmitters and the associated sensors and accessories, carry a one-year warranty from the date of purchase of the same. ALL PRODUCTS RECEIVED BY DIRECTED FOR WARRANTY REPAIR WITHOUT PROOF OF PURCHASE WILL BE DENIED. This warranty is non-transferable and is automatically void if: the original purchaser has not completed the warranty card and mailed it within ten (10) days from the date of purchase to the address listed on the card; the unit's date code or serial number is defaced, missing or altered; the unit has been modified or used in a manner contrary to its intended purpose; the unit has been damaged by accident, unreasonable use, neglect, improper service, installation or other causes not arising out of defects in materials or construction. The warranty does not cover damage to the unit caused by installation or removal of the unit. Directed, in its sole discretion, will determine what constitutes excessive damage and may refuse the return of any unit with excessive damage.

TO THE MAXIMUM EXTENT ALLOWED BY LAW, ALL WARRANTIES, INCLUDING BUT NOT LIMITED TO EXPRESS WARRANTY, IMPLIED WARRANTY, WARRANTY OF MERCHANTABILITY, FITNESS FOR PARTICULAR PURPOSE AND WARRANTY OF NON-INFRINGEMENT OF INTELLECTUAL PROPERTY, ARE EXPRESSLY EXCLUDED; AND DIRECTED NEITHER ASSUMES NOR AUTHORIZES ANY PERSON OR ENTITY TO ASSUME FOR IT ANY DUTY, OBLIGATION OR LIABILITY IN CONNECTION WITH ITS PRODUCTS. DIRECTED DISCLAIMS AND HAS ABSOLUTELY NO LIABILITY FOR ANY AND ALL ACTS OF THIRD PARTIES INCLUDING ITS AUTHORIZED DEALERS OR INSTALLERS. DIRECTED SECURITY SYSTEMS, INCLUDING THIS UNIT, ARE DETERRENENTS AGAINST POSSIBLE THEFT. DIRECTED IS NOT OFFERING A GUARANTEE OR INSURANCE AGAINST VANDALISM, DAMAGE OR THEFT OF THE AUTOMOBILE, ITS PARTS OR CONTENTS; AND HEREBY EXPRESSLY DISCLAIMS ANY

LIABILITY WHATSOEVER, INCLUDING WITHOUT LIMITATION, LIABILITY FOR THEFT, DAMAGE AND/OR VANDALISM. THIS WARRANTY DOES NOT COVER LABOR COSTS FOR MAINTENANCE, REMOVAL OR REINSTALLATION OF THE UNIT OR ANY CONSEQUENTIAL DAMAGES OF ANY KIND. IN THE EVENT OF A CLAIM OR A DISPUTE INVOLVING DIRECTED OR ITS SUBSIDIARY, THE VENUE SHALL BE SAN DIEGO COUNTY IN THE STATE OF CALIFORNIA. CALIFORNIA STATE LAWS AND APPLICABLE FEDERAL LAWS SHALL APPLY AND GOVERN THE DISPUTE. THE MAXIMUM RECOVERY UNDER ANY CLAIM AGAINST DIRECTED SHALL BE STRICTLY LIMITED TO THE AUTHORIZED DIRECTED DEALER'S PURCHASE PRICE OF THE UNIT. DIRECTED SHALL NOT BE RESPONSIBLE FOR ANY DAMAGES WHATSOEVER, INCLUDING BUT NOT LIMITED TO, ANY CONSEQUENTIAL DAMAGES, INCIDENTAL DAMAGES, DAMAGE TO VEHICLE, DAMAGES FOR THE LOSS OF TIME, LOSS OF EARNINGS, COMMERCIAL LOSS, LOSS OF ECONOMIC OPPORTUNITY AND THE LIKE. NOTWITHSTANDING THE ABOVE, THE MANUFACTURER DOES OFFER A LIMITED WARRANTY TO REPLACE OR REPAIR THE CONTROL MODULE SUBJECT TO THE CONDITIONS AS DESCRIBED HEREIN. THIS WARRANTY IS VOID IF THE UNIT HAS NOT BEEN PURCHASED FROM DIRECTED, OR AN AUTHORIZED DIRECTED DEALER, OR IF THE UNIT HAS BEEN DAMAGED BY ACCIDENT, UNREASONABLE USE, NEGLIGENCE, ACTS OF GOD, NEGLIGENCE, IMPROPER SERVICE, OR OTHER CAUSES NOT ARISING OUT OF DEFECT IN MATERIALS OR CONSTRUCTION.

Some states do not allow limitations on how long an implied warranty will last or the exclusion or limitation of incidental or consequential damages. This warranty gives you specific legal rights and you may also have other rights that vary from State to State. This warranty is only valid for sale of product(s) within the United States of America. Product(s) sold outside of the United States of America are sold "AS-IS" and shall have NO WARRANTY, express or implied. This product may be covered by a Guaranteed Protection Plan ("GPP"). See your authorized Directed dealer for details of the plan or call Directed Customer Service at 1-800-876-0800.

Make sure you have all of the following information from your authorized Directed dealer:

A clear copy of the sales receipt, showing the following:

- Date of purchase
- Your full name and address
- Authorized dealer's company name and address
- Type of alarm installed
- Year, make, model and color of the automobile
- Automobile license number
- Vehicle identification number
- All security options installed on automobile
- Installation receipts



