

VIPER®

Responder LE Model 5301 Remote Start Keyless Entry Installation Guide

This product is intended for installation by a professional installer only! Attempts to install this product by a person other than a trained professional may result in severe damage to a vehicle's electrical system and components.

Directed®
E L E C T R O N I C S

© 2008 Directed Electronics, Vista, CA
N4202V 2008-06

Bitwriter®, Code Hopping™, Doubleguard®, ESP2™, Fail-Safe®, Ghost Switch™, Learn Routine™, Nite-Lite®, Nuisance Prevention® Circuitry, Revenger®, Silent Mode™, Soft Chirp®, Stinger®, Valet®, Vehicle Recovery System®, VRS®, and Warn Away® are all Trademarks or Registered Trademarks of Directed Electronics.



The Bitwriter® (p/n 998U) requires chip version 2.5 or newer to program this unit.

Bitwriters with date code of 6A or older require an IC upgrade (p/n 998M). Some Bitwriters with a date code of 6B do not require the IC upgrade. Refer to Tech Tip # 1112 for more information. Bitwriter 2 compatible.



Contents

Warning! Safety first	5
What is included.....	7
Installation points to remember.....	7
Virtual tach	7
D2D.....	8
The control center	8
Valet® program switch	9
Status LED.....	9
Before beginning the installation.....	10
After the installation	10
Component locations and finding wires	11
Making your wiring connections	11
Primary harness (H1), 12-pin connector.....	12
Auxiliary harness (H2), 7-pin connector.....	12
Heavy gauge remote start, (H3) 8-pin connector.....	13
Remote start input, 5-pin connector	13
Remote start auxiliary output, 5-pin	14
Door lock harness, 3-pin connector	14
Wire connection guides.....	15
Primary harness (H1).....	15
Auxiliary harness (H2).....	21
Heavy Gauge, 8-pin connector.....	25
Remote start input - 5-pin connector.....	27
Remote start auxiliary output, 5-pin	29
Door lock wire diagrams	30
Neutral safety switch interface	31
Testing the neutral safety switch	31
Plug-in LED and valet/program switch.....	32
Bitwriter interface - 3-pin black plug	32
Tachometer settings	33
Virtual tach	33
Tach learning	34
Tach threshold On/Off	35
D2D Jumper settings	35
Setting the light flash polarity.....	36
Remote control learn routine.....	37
Remote control configuration	40
Responder LE 2-way.....	40
System features learn routine	42

Feature menus	45
Menu 1 - Keyless entry	45
Menu 2 - Convenience	46
Menu 3 - Remote start	47
Feature descriptions.....	48
Menu 1 - Keyless entry	48
Menu 2 - Convenience	50
Menu 3 - Remote start	53
Bitwriter®	57
Valet mode.....	58
Remote starting the vehicle	59
Manual transmission remote start	60
Timer mode	61
Shutdown diagnostics	63
Remote starting diagnostics	64
Remote start safety check	65
Troubleshooting	66
Keyless entry system.....	66
Remote start	66

Warning! Safety first

The following safety warnings must be observed at all times:

- Due to the complexity of this system, installation of this product must only be performed by an authorized Directed Electronics dealer.
- When properly installed, this system can start the vehicle via a command signal from the remote control. Therefore, never operate the system in an area that does not have adequate ventilation.

The following precautions are the sole responsibility of the user; however, authorized Directed Electronics dealers should:

- **Never use a test light or logic probe when installing this unit. Always use a multimeter.**
- Never operate the system in an enclosed or partially enclosed area without ventilation (such as a garage).
- When parking in an enclosed or partially enclosed area or when having the vehicle serviced, the remote start system must be disabled using the installed toggle switch. It is the user's sole responsibility to properly handle and keep out of reach from children all remote controls to assure that the system does not unintentionally remote start the vehicle.

USER MUST INSTALL A CARBON MONOXIDE DETECTOR IN OR ABOUT THE LIVING AREA ADJACENT TO THE VEHICLE. ALL DOORS LEADING FROM ADJACENT LIVING AREAS TO THE ENCLOSED OR PARTIALLY ENCLOSED VEHICLE STORAGE AREA MUST REMAIN CLOSED AT ALL TIMES.

Use of this product in a manner contrary to its intended mode of operation may result in property damage, personal injury, or death. Except when performing the Safety Check outlined in this installation guide, (1) Never remotely start the vehicle with the vehicle in gear, and (2) Never remotely start the vehicle with the keys in the ignition. The user will be responsible for having the neutral safety feature of the vehicle periodically checked, wherein the vehicle must not remotely start while the car is in gear. This testing should be performed by an authorized Directed Electronics dealer in accordance with the Safety Check outlined in this product installation guide. If the vehicle starts in gear, cease remote start operation immediately and consult with the user to fix the problem immediately.

After the remote start module has been installed, test the remote start module in accordance with the Safety Check outlined in this installation guide. If the vehicle starts when performing the Neutral Safety Shutdown Circuit test, the remote start unit has not been properly installed. The remote start module must be removed or properly reinstalled so that the vehicle does not start in gear. All installations must be performed by an authorized Directed Electronics dealer.

OPERATION OF THE REMOTE START MODULE IF THE VEHICLE STARTS IN GEAR IS CONTRARY TO ITS INTENDED MODE OF OPERATION. OPERATING THE REMOTE START SYSTEM UNDER THESE CONDITIONS MAY RESULT IN PROPERTY DAMAGE OR PERSONAL INJURY. IMMEDIATELY CEASE THE USE OF THE UNIT AND REPAIR OR DISCONNECT THE INSTALLED REMOTE START MODULE. DIRECTED ELECTRONICS, INC. WILL NOT BE HELD RESPONSIBLE OR PAY FOR INSTALLATION OR REINSTALLATION COSTS.

Remote starters for manual transmission pose significant risks if not properly installed and operated. When testing to ensure the installation is working properly, only remote start the vehicle in neutral gear, on a flat surface and with a functional, fully engaged parking brake. Do not allow anyone to stand in front of or behind the vehicle.

This product should **not** be installed in any convertible vehicles, soft or hard top with a manual transmission. Installation in such vehicles may pose certain risk.

What is included

- The control module
- Control center with integrated status LED and Valet Override switch (p/n 6211T)
- One five-button/2-way Supercode Responder LE Remote Control, (p/n 7251V)
- One five-button /1-way Supercode Remote (p/n 7152V)
- A shut-down toggle switch

Installation points to remember

This product is designed for fuel-injected, automatic transmission, or vehicles with manual transmissions.

Important! The default option "Manual" is a safety precaution that forces the installer to enable the Manual Transmission Start (MTS) routine or program the unit to the "Automatic" option before the remote start can be activated for the first time.

The "Automatic" option should be programmed on to work with automatic transmissions. When the "Manual" option is selected a specific routine is required before exiting the vehicle to enable the MTS mode.

► Virtual tach

Virtual Tach is a new feature for Directed this year. It is the default RPM-sensing method for the new Responder LE hybrid keyless entry /remote start systems.

Virtual Tach gives the installer the performance of a hard wired tach wire, with the convenience of voltage sensing. It is far superior to any voltage-sense feature you've tried before.

Virtual Tach monitors the cranking voltage of the vehicle using a very fast micro controller and an analog-to-digital converter. The microprocessor "saves" the base voltage as a reference. When Virtual Tach "sees" the slightest uptick in voltage, indicating that the alternator is charging the battery, the starter motor shuts off instantly.

► D2D

The system has the ability to interface with an XK module through the D2D port. The advantage to using a D2D interface is that there is less wiring involved in the installation. Check the XK module installation guide to determine which wires are not needed, and which options are available.

► The control center

The control center position should be discussed with the vehicle's owner prior to installation. The LED and Valet switch is housed on the control center, so you will want to make sure that the customer is satisfied with the location.

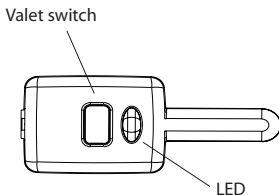

► Valet® program switch

The valet/program switch is built into the control center.

Important: When the vehicle is delivered, please show the user where this switch is located and how to disarm the system with it.

Note: An optional valet switch (p/n #8631) is available if the onboard valet switch is not used for the install.

When installing the external valet switch ensure that the location has sufficient clearance to the rear. The switch should be well hidden. It should be placed so passengers or stored items (such as in a glove box or center console) cannot accidentally hit it. The switch fits into a 9/32-inch hole.

► Status LED

The status LED is built into the control center. An optional LED (p/n 8634) is available if the onboard LED will not be used for the install. The LED fits into a 9/32-inch hole.

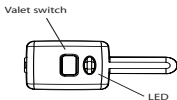

➤ Before beginning the installation

- Please read this entire installation guide before beginning the installation. The installation of this remote start system requires interfacing with many of the vehicle's systems. Many new vehicles use low-voltage or multiplexed systems that can be damaged by low resistance testing devices, such as test lights and logic probes (computer safe test lights). Test all circuits with a high quality digital multi-meter before making connections.
- Do not disconnect the battery if the vehicle has an anti-theft-coded radio. If equipped with an air bag, avoid disconnecting the battery if possible. Many airbag systems display a diagnostic code through the warning lights after the lights lose power. Disconnecting the battery causes the anti-theft code to be erased, which can then require a trip to the dealer.
- If using an external LED or Valet Switch, check with the customer about where to locate the switch.
- To avoid accidental battery drainage; turn off the interior lights or remove the dome light fuse.
- Roll down a window to avoid being locked out of the car.

➤ After the installation

- Test all functions. The Using Your System section of the Owner's Guide is very helpful when testing.
- Review and complete the Safety Check section of this guide prior to the vehicle reassembly.

Component locations and finding wires

For detailed information on where to locate components, and how to find the wires you need, please refer to the Direct Tech web site at www.directechs.com.

Making your wiring connections

Before making your connections, plan how your wires will be routed through the vehicle. For instance, the red 12V constant input and the remote start ignition wires are often routed together to the ignition switch harness. In order to keep the wiring neat and make it harder to find, you may wish to wrap these wires together in electrical tape or conceal them in tubing similar to what the manufacturer used.

There are two acceptable ways of making a wire connection - solder connections and crimp connectors. When properly performed, either type of connection is reliable and trouble-free. Regardless of whether you solder your connections or you use mechanical type crimp-on connections, ensure that all connections are mechanically sound and that they are insulated, especially when connecting data lines in the vehicle.

Cheap electrical tape, especially when poorly applied, is not a reliable insulator. It often falls off in hot weather. Use good quality electrical tape or heat shrink.

- Never twist-and-tape the wires together without soldering.
- Never use "fuse taps", as they can damage fuse box terminals.

If you use tapping connectors such as T-Taps (not to be confused with Scotch-Locks), avoid using them in higher-current applications (constant 12V, ground, etc.) These connectors are inferior in quality and should be avoided.

► Primary harness (H1), 12-pin connector

H1/1	RED/WHITE	(-) 200mA TRUNK RELEASE OUTPUT
H1/2	RED	(+)12v CONSTANT INPUT
H1/3	BROWN	(-) HORN OUTPUT
H1/4	WHITE/BROWN	LIGHT FLASH ISOLATION WIRE - PIN 87a of onboard relay
H1/5	BLACK	(-) CHASSIS GROUND
H1/6	VIOLET	(+) DOOR TRIGGER INPUT*
H1/7	BLUE	(-) FACTORY HORN INPUT
H1/8	GREEN	(-) DOOR TRIGGER INPUT*
H1/9	BLACK/WHITE	(-) 200mA DOME LIGHT OUTPUT
H1/10	WHITE/BLUE	(-) REMOTE START/ TURBO TIMER ACTIVATION INPUT
H1/11	WHITE	PARKING LIGHT OUTPUT
H1/12	ORANGE	(-) 500mA GROUND WHEN ARMED OUTPUT

*Door trigger input is needed if one of the following are used: MTS, passive arming, auto re-locking, door ajar error honk or Smart Key control.

► Auxiliary harness (H2), 7-pin connector

H2/1	LIGHT GREEN/ BLACK	(-) 200mA FACTORY ALARM DISARM OUTPUT
H2/2	LIGHT GREEN/ WHITE	(-) 200mA FACTORY ALARM ARM OUTPUT
H2/3	WHITE/VIOLET	(-) 200mA AUX 1 OUTPUT
H2/4	VIOLET/BLACK	(-) 200mA AUX 2 OUTPUT
H2/5	WHITE/BLACK	(-) 200mA AUX 3 OUTPUT
H2/6	LIGHT BLUE	(-) 200mA 2ND UNLOCK OUTPUT
H2/7	GRAY/BLACK	(-) DIESEL WAIT TO START INPUT

There are three harness connections relative to remote start function, including the heavy gauge and input and output harnesses.

➤ Heavy gauge remote start, (H3) 8-pin connector

H3/1	PINK	IGNITION 1 INPUT/OUTPUT
H3/2	RED/WHITE	(+) FUSED (30A) IGNITION 2 / FLEX RELAY INPUT 87
H3/3	ORANGE	ACCESSORY OUTPUT
H3/4	VIOLET	STARTER OUTPUT
H3/5	RED	(+) FUSED (30A) IGNITION 1 INPUT
H3/6	PINK/WHITE	(+) IGNITION 2 / FLEX RELAY OUTPUT 30
H3/7	PINK/BLACK	FLEX RELAY INPUT 87A key side (if required) of FLEX RELAY
H3/8	RED/BLACK	(+) FUSED (30A) ACCESSORY/STARTER INPUT

➤ Remote start input, 5-pin connector

1	BLACK/WHITE	(-) NEUTRAL SAFETY SWITCH INPUT
2	VIOLET/WHITE	TACHOMETER INPUT
3	BROWN	(+) BRAKE SHUTDOWN INPUT
4	GRAY	N/O or N/C (-) HOOD PIN SWITCH INPUT
5	BLUE/WHITE	(-) 200 mA 2ND STATUS/REAR DEFOGGER OUTPUT

➤ Remote start auxiliary output, 5-pin

1	PINK/WHITE	(-) 200mA FLEX RELAY CONTROL OUTPUT
2	ORANGE	(-) 200mA ACCESSORY OUTPUT
3	VIOLET	(-) 200mA STARTER OUTPUT
4	PINK	(-) 200mA IGNITION 1 OUTPUT
5	BLUE	(-) 200mA STATUS OUTPUT

Note: Wires 1 - 4 on the remote auxiliary outputs are wired to the (-) triggers for the onboard remote start relays and are not diode isolated. If connecting these wires directly to the vehicle you must place a 1-amp diode in line to prevent feedback from the vehicle.

➤ Door lock harness, 3-pin connector

1	BLUE	(+) LOCK (-) UNLOCK OUTPUT
2	EMPTY	NOT USED
3	GREEN	(-) LOCK (+) UNLOCK OUTPUT

Wire connection guides

► Primary harness (H1)

H1/1

RED/WHITE

(-) 200mA TRUNK RELEASE OUTPUT

When the system receives the code controlling trunk release output for longer than 1.5 seconds, the red/white wire will supply an output as long as the transmission continues. This is typically used to operate a trunk/hatch release or other relay-driven function.

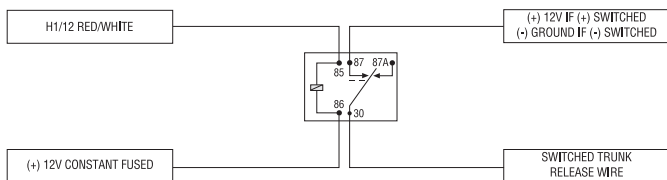

Warning! Never use this wire to drive anything but a relay or a low-current input, supplied output is only 200mA. Connecting directly to a solenoid, motor, or other high-current device will cause the module to fail.

H1/2

RED

(+)12v CONSTANT INPUT

Before connecting this wire, remove the supplied fuse. Connect to the battery positive terminal or the constant 12V supply to the ignition switch.

Note: Always use a fuse within 12 inches of the point you obtain (+)12V. Do not use the 15A fuse in the harness for this purpose. This fuse protects the module.

H1/3**BROWN****(-) HORN OUTPUT**

This wire supplies a (-) 200 mA output that can be used to honk the vehicle horn. It outputs a single pulse when locking the doors with the remote, and two pulses when unlocking with the remote. This wire also outputs pulses for 30 seconds when Panic Mode is activated. If the vehicle has a (+) horn circuit, an optional relay can be used to interface with the system.

H1/4**WHITE/BROWN****LIGHT FLASH - ISOLATION WIRE - PIN 87a of onboard relay**

This wire connects to pin 87a of the onboard light flash relay. It is used whenever light switch isolation on the vehicle is necessary. If the vehicle has a multiplex circuit that needs the light switch isolated, you can remove the onboard light flash fuse and replace it with the specified resistor (paying attention to the polarity selection).

Multiplex Lightflash Interface

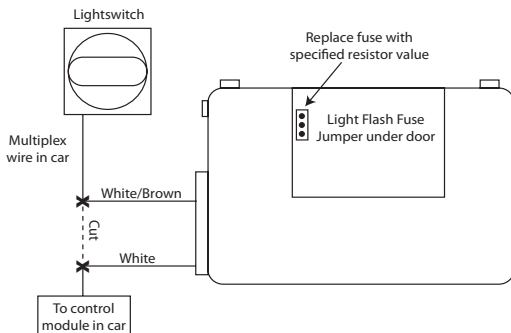

H1/5**BLACK****(-) CHASSIS GROUND**

We recommend that you do not use a factory ground. Ground all your components to the same point in the vehicle, (preferably the kick panel). Scrape away any paint and use a factory bolt or make your own ground with a self-tapping screw and a star washer.

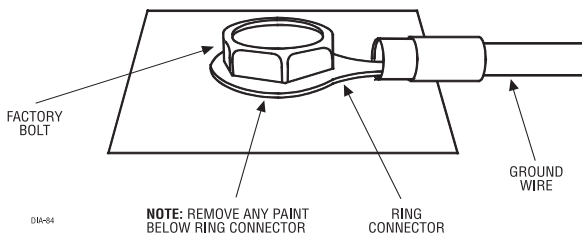

014-04

H1/6**VIOLET****(+) DOOR TRIGGER INPUT***

This wire is used in vehicles that have a positive (+) switched dome light circuit. Connect the violet wire to a wire that shows (+) 12V when any door is opened, and ground when the door is closed.

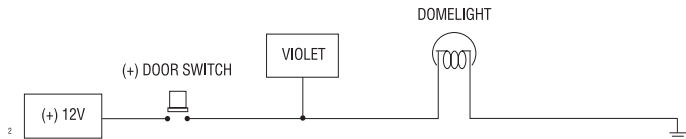

*Door trigger input is needed if one of the following are used: MTS, passive arming, auto re-locking, door ajar error honk or Smart Key control.

This optional input can be wired to the factory horn honk output of the vehicle. When this wire receives an input for a minimum of .5 seconds, the system reports a trigger on the remote. This is useful on vehicles that have a factory security system, it notifies the owner that the system was triggered.

Note: The system does not report that a zone has been triggered when unlocking with the remote. Connect to the wire in the vehicle that shows voltage when the factory alarm system is triggered. If the vehicle has a (+) horn circuit, an optional relay can be used to interface with the system, as shown below.

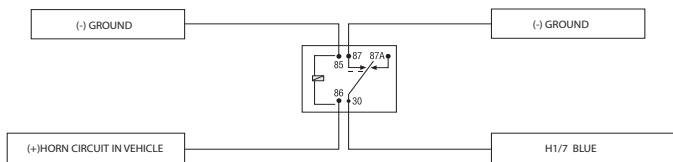

Most vehicles use negative door trigger circuits. Connect the green wire to a wire which shows ground when any door is opened. In vehicles with factory delays on the dome light circuit, there is usually a wire that is unaffected by the delay circuitry.

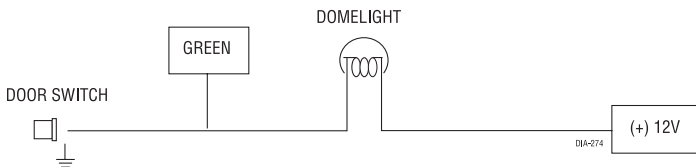

*Door trigger input is needed if one of the following are used: MTS, passive arming, auto re-locking, door ajar error honk or Smart Key control.

H1/9**BLACK/WHITE****(-) 200mA DOME LIGHT OUTPUT**

Connect this wire to the optional dome light supervision relay as shown below: Important! This output is only intended to drive a relay. It cannot be connected directly to the dome light circuit, as the output cannot support the current draw of one or more light bulbs.

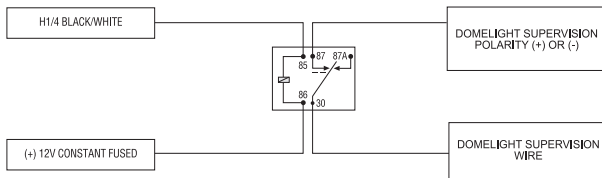
**H1/10****WHITE/BLUE****(-) REMOTE START/ TURBO TIMER ACTIVATION INPUT**

This input comes from the factory set to 1 activation pulse. This means that it is necessary to have a single ground pulse on the white/blue wire for the remote start to activate or to deactivate.

The **H1/10** wire can also be used to activate the Turbo Timer mode when the car is running and this wire receives a ground.

Note: The number of activation inputs can be programmed to 1 or 2 pulses with an optional momentary switch. This setting affects both the input wire and the remote control when operating the remote starter.

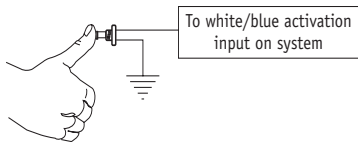

H1/11**WHITE****PARKING LIGHT OUTPUT**

This wire should be connected to the parking light wire in the vehicle. See Setting the light flash polarity section of this guide for polarity settings.

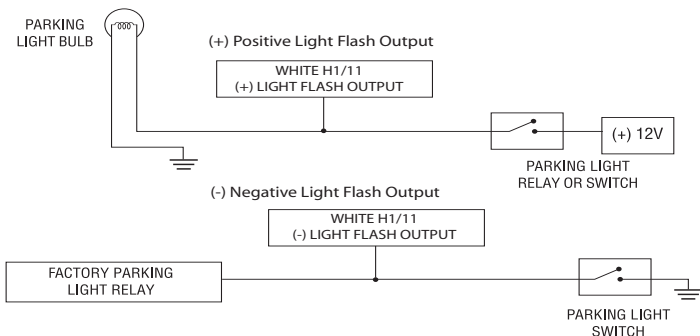

Note: For parking light circuits that draw 10-amps or more, the internal jumper must be switched to a (-) light flash output. (See Setting the light flash polarity section of this guide.) P/N 8617 or a standard automotive SPDT relay must be used on the H1/11 light flash output harness wire.

H1/12**ORANGE****(-) 500mA GROUND WHEN ARMED OUTPUT**

This wire supplies a (-)500 mA ground as long as the system is locked and when the remote start is activated. (This feature can be turned off by programming the anti-grind option Off). This output ceases as soon as the system is unlocked. The GWA can be hooked up to an optional starter kill/anti-grind relay control module, a voice module or any accessory that requires a ground when armed.

Note: The one time bypass feature does not disable function.

► Auxiliary harness (H2)

H2/1

LIGHT GREEN/BLACK

(-) 200mA FACTORY ALARM DISARM OUTPUT

This wire sends a negative pulse every time the remote start is activated, channel 2 is activated (programmable on/off) or when the doors are unlocked with the remote. This can be used to pulse the disarm wire of the vehicle's factory anti-theft device. Use a relay to send a (-) or (+) pulse to the disarm wire as shown in the following diagrams.

**Relay for Negative (-)
Disarm Wire**

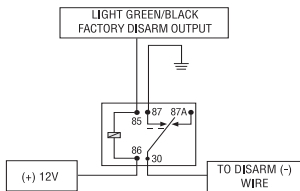

**Relay for Positive (+)
Disarm Wire**

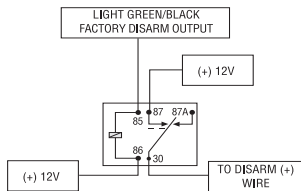

DE-138

H2/2

LIGHT GREEN/WHITE

(-) 200mA FACTORY ALARM ARM OUTPUT

This wire sends a negative pulse every time the remote start shuts down or when the doors are locked with the remote. This can be used to pulse the arm wire of the vehicle's factory anti-theft device. Use a relay to send a (-) or (+) pulse to the arm wire.

H2/3**WHITE/VIOLET****(-) 200mA AUX 1 OUTPUT**

This wire provides 200 mA programmable output whenever the transmitter buttons controlling Aux 1 channel is pressed. (See descriptions for Aux 3)



Warning! Never use this wire to drive anything but a relay or a low-current input, supplied output is only 200mA. Connecting directly to a solenoid, motor, or other high-current device will cause the module to fail.

H2/4**VIOLET/BLACK****(-) 200mA AUX 2 OUTPUT**

This wire provides 200 mA programmable output whenever the transmitter buttons controlling Aux 2 channel is pressed. (See descriptions for Aux 3.)



Warning! Never use this wire to drive anything but a relay or a low-current input, supplied output is only 200mA. Connecting directly to a solenoid, motor, or other high-current device will cause the module to fail.

H2/5**WHITE/BLACK****(-) 200mA AUX 3 OUTPUT**

This wire provides 200 mA programmable output whenever the transmitter button(s) controlling Aux 3 is pressed. This output can be programmed to provide the following types of outputs

- **Validity:** Output that sends a signal as long as the transmission is received.
- **Latched:** Output that sends a signal when the Aux channel button is pressed and continues until the same button is pressed.

- Latched, reset with ignition: Similar to the latched output, this type of output turns On the first time the Aux channel button is pressed, and turns Off the next time the same button is pressed. This type of output additionally stops and resets whenever the ignition is turned On and then Off.
- 30 seconds timed: The output sends a continuous signal for 30 seconds.

Note: Bitwriter® programs from 1 to 90 seconds.

	<p>Warning! Never use this wire to drive anything but a relay or a low-current input, supplied output is only 200mA. Connecting directly to a solenoid, motor, or other high-current device will cause the module to fail.</p>
---	---

H2/6	LIGHT BLUE	(-) 200mA 2ND UNLOCK OUTPUT
-------------	-------------------	------------------------------------

This wire produces a (-) 200mA output for progressive locks in which the driver door unlocks first and the remaining locks will unlock with a second press of the unlock button on the remote.

Note: This feature will need to be programmed “On” to function correctly (see System Feature Menu #1, feature 8).

H2/7	GRAY/BLACK	(-) DIESEL WAIT TO START INPUT
-------------	-------------------	---------------------------------------

Connect this wire to the wire in the vehicle that sends the signal to turn on the WAIT-TO-START bulb in the dashboard. In most diesels the wire is negative (ground turns on the bulb) and the GRAY/BLACK wire can be directly connected to the wire in the vehicle. If the vehicle uses a positive wire (12V to turn on the bulb) a relay must be used to change the polarity.

The system has a programmable onboard timer (See Feature menu#3, feature 9) so it is not mandatory to connect to the wait-to-start wire in the vehicle.

Note: A 1-amp diode must be installed in line on the factory wire between the wait-to-start indicator and the ECM. (See the following diagram for details).

(-) WAIT TO START WIRE

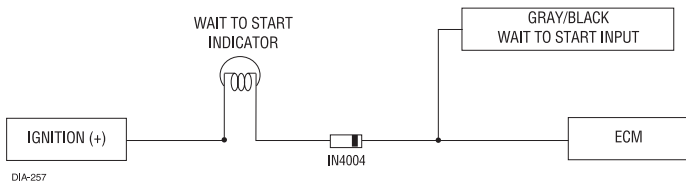

(+) WAIT-TO-START WIRE

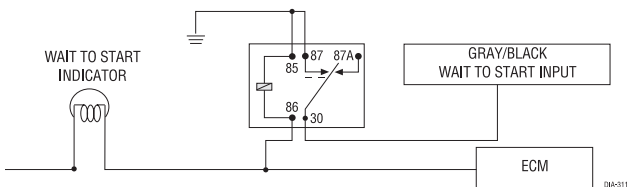

► Heavy Gauge, 8-pin connector

There are 8 heavy gauge wires coming from the large 8-pin connector. They are used to energize the ignition circuits in the vehicle. It is crucial to ensure that these connections are capable of handling the current demands. For this reason, Scotch-Locks, T-taps and other such connectors are strongly discouraged.

H3/1	PINK	(+) IGNITION 1 INPUT/OUTPUT
-------------	-------------	------------------------------------

Connect this wire to the ignition wire in the vehicle. This wire not only supplies voltage for the ignition line in the vehicle, it is also the ignition feed for the remote start system.

H3/2	RED/WHITE	(+) FUSED (30A) FUSED IGNITION 2 /FLEX RELAY INPUT 87
-------------	------------------	--

This wire is the polarity feed for the ignition 2/flex relay.

H3/3	ORANGE	ACCESSORY OUTPUT
-------------	---------------	-------------------------

Connect this wire to the accessory wire that powers the climate control system

H3/4	VIOLET	STARTER OUTPUT
-------------	---------------	-----------------------

Connect this wire to the starter wire in the vehicle.

H3/5	RED	(+) FUSED (30A) IGNITION 1 INPUT
-------------	------------	---

This wire is the polarity feed for the Ignition 1 relay.

H3/6	PINK/WHITE	IGNITION 2 / FLEX RELAY OUTPUT 30
-------------	-------------------	--

This wire is factory programmed as Ignition 2 and can be programmed as a 2nd accessory or 2nd starter.

H3/7**PINK/BLACK****FLEX RELAY INPUT 87A key side (if required) of FLEX RELAY**

This wire is used when an ignition switch isolation on the vehicle is necessary. This is common on Toyota and Nissans which required the use of Tech Tip document #1077. (See menu # 3 Feature 8 for programming options) See the diagram below for more wiring detail.)

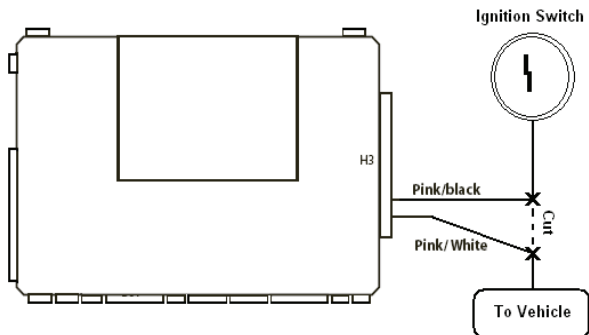
**H3/8****RED/BLACK****(+) FUSED (30A) ACCESSORY/STARTER INPUT**

This wire is the polarity feed to the accessory and starter relays.

➤ Remote start input - 5-pin connector

1	BLACK/WHITE	(-) NEUTRAL SAFETY SWITCH INPUT
----------	--------------------	--

Connect this wire to a ground source if installing this unit in an automatic transmission vehicle. If this unit is being installed in a manual transmission vehicle then connect it to the emergency brake wire. This input **MUST** rest at ground in order for the remote start system to operate.

Important! Always perform the steps outlined in Safety Check section to verify that the vehicle cannot be started in ANY drive gear and that the override switch is functioning properly.

2	VIOLET/WHITE	TACHOMETER INPUT WIRE
----------	---------------------	------------------------------

This input provides the module with information about the engine's revolutions per minute (RPMs). It can be connected to the uncommon colored wire of the fuel injector, the crankshaft position sensor, the camshaft position sensor or the negative side of the coil in vehicles with conventional coils. In multi-coil and high energy ignition systems locating a proper signal may be more difficult. (See Finding the Wires You Need section of this guide.) Once connected, you must teach the system the tach signal.

Note: This wire **MUST** be used when installing this unit on a manual transmission vehicle.

3	BROWN	(+) BRAKE SHUTDOWN WIRE
----------	--------------	--------------------------------

This wire **MUST** be connected to the vehicle's brake light wire. This is the wire that shows (+) 12V when the brake pedal is depressed. The remote start will be disabled or shut down any time the brake pedal is depressed. Note: This wire **MUST** be used when installing this unit on a manual transmission vehicle.

4**GRAY****N/O or N/C (-) HOOD PIN SWITCH INPUT**

This wire **MUST** be connected to a hoodpin switch. This input will disable or shut down the remote start when the hood is opened.

(See Feature Descriptions, Menu #1 feature 11 for details about programming.)

5**BLUE/WHITE****(-) 200 mA 2ND STATUS/REAR DEFOGGER OUTPUT**

This wire supplies a 200mA output as soon as the module begins the remote start process. The Blue/White wire can also be used to activate the defogger trigger (latched/pulsed) 10-seconds after the remote start engages. (See the Feature Descriptions, Menu#3, feature 11 for details about programming this output.)

► Remote start auxiliary output, 5-pin

These signals are provided to drive additional optional relays.

1	PINK/WHITE	(-) 200mA FLEX RELAY CONTROL OUTPUT
----------	-------------------	--

This wire is programmed as (-) 2nd ignition output from factory and can be programmed (to drive a relay) as a (-) starter or an accessory output. (See Feature programming Menu 3, feature 8.)

2	ORANGE	(-) 200mA ACCESSORY OUTPUT
----------	---------------	-----------------------------------

This wire works like the main accessory wire and can be used (with a relay) to drive any additional accessory circuits in the vehicle.

3	VIOLET	(-) 200mA STARTER OUTPUT
----------	---------------	---------------------------------

This wire works like the starter wire and can be used (with a relay) to drive any additional starter circuits in the vehicle.

4	PINK	(-) 200mA IGNITION 1 OUTPUT
----------	-------------	------------------------------------

This wire works like the ignition 1 wire and can be used (with a relay) to drive any additional ignition circuits in the vehicle.

Note: Wires 1 - 4 on the remote start auxiliary outputs are wired to the (-) triggers for the onboard remote start relays and are not diode isolated. If connecting these wires directly to the vehicle you must place a 1-amp diode in line to prevent feedback from the vehicle.

5	BLUE	(-) 200mA STATUS OUTPUT
----------	-------------	--------------------------------

This wire supplies an output as soon as the module begins the remote start process. It can be used to activate a bypass module or power the key sense wire in most vehicles to disarm the factory alarm without unlocking.

Note: Check vehicle information to verify if a bypass module is needed or if the key sense wire is needed.

► Door lock wire diagrams

Important: Depending on the vehicle, the door locks may be controlled by an optional data bus expansion module. If so, no door lock interface wiring is required.

There are eight different types of door lock systems (Type A - H).

Type A: Three-wire (+) pulse controlling factory lock relays.

Type B: Three-wire (-) pulse controlling factory lock relays.

Type C: Direct-wired reversing-polarity switches. The switches are wired directly to the motors. This type of system has no factory relays.

Type D: Adding one or more aftermarket actuators. These include central locking systems without an actuator in the driver's door, but with factory actuators in all the other doors.

Type E: Electrically-activated vacuum systems.

Type F: One-wire system - cut to lock, ground to unlock.

This is a very rare system found mainly in early 90's imports and some newer Hyundais.

Type G: Positive (+) multiplex. One wire controls lock and unlock using resistors).

Type H: Negative (-) multiplex. Same as Type G system, but uses (-) pulse instead.

Note: You can use a 456L door lock learn module for Type G and H, instead of relays and resistors. For additional information and wiring diagrams see Document 1041 at www.directechs.com under the Resource tab.

Neutral safety switch interface

Some vehicles do not have an electrical neutral safety switch. Instead, the vehicle has a mechanical neutral safety switch that physically interrupts the starter wire and is used when the vehicle is in any drive gear. If the remote start is interfaced before this switch, it will provide protection from starting in gear. However, some vehicles combine the column shift mechanism and the mechanical neutral safety switch into one mechanical part.

Note: You must complete the remote start system installation before doing the following test. Ensure that the remote start system is functioning normally. This includes connecting to the brake as a shut-down.

► Testing the neutral safety switch

1. Make sure there is adequate clearance to the front and rear of the vehicle because it may move slightly.
2. Make sure the hood is closed and there are no remote start shut-downs active.
3. Set the emergency brake.
4. Turn the key to the "run" position, this will release the shifter.
5. Place the car in drive (D).
6. Place your foot directly over the brake pedal, but do not depress it. Be ready to step on the brake if the starter engages.
7. Activate the remote start system.
8. If the starter engages, immediately depress the brake to shut the remote start system down. If the starter does not engage, no additional safety system is required.

If the starter engages and the vehicle is a General Motors product or Dodge Dakota pickup, you can find an alternative shut-down method to prevent the starter from engaging. Refer to www.directechs.com for Document 1008 under the Resource tab. If the vehicle is not a General Motors product or a Dodge Dakota pickup, please call Directed Electronics Technical Support for an alternative shut-down method.

Do not return the vehicle to the customer until this feature is properly installed!

Plug-in LED and valet/program switch

The LED and valet switch are incorporated into the control center the LED line will plug into the white 2-pin port and the Valet switch line will plug into the blue 2-pin port.

Note: Onboard LED and valet switch can be substituted with an optional outboard LED (P/N 8634 for Blue LED and 8633 for red LED) and an outboard valet switch (P/N 8631).

Bitwriter interface - 3-pin black plug

The black 3-pin port is provided for programming the unit using the Bitwriter (p/n 998T). When using the Bitwriter, it is possible to configure any and all of the programmable functions as well as lock the Remote Control and System Features Learn Routines so that unauthorized users cannot change the configuration or program remote controls to the unit.



When the learn routines have previously been programmed using the Bitwriter, they may have been locked. Before proceeding with reprogramming the learn routines, they must be unlocked with the Bitwriter - this cannot be done manually with the Valet switch.

Note: Bitwriters require software v2.5. Bitwriters with date code of 6A or older require an IC upgrade (p/n 998M). Some bitwriters with a date code of 6B do not require the IC upgrade, refer to Tech Tip # 1112 for more information. Bitwriter 2 compatible.

Tachometer settings

► Virtual tach

To program Virtual Tach:

1. After the install is complete, remote start the car.
2. If the car does not start on the first attempt, let the remote start attempt again.
3. Once the car starts, let it run until the parking lights come on.
4. When the parking lights come on, shut off the remote start with the remote - that's it! Virtual Tach is programmed.

To reset Virtual Tach, go into the remote programming grid and choose option #4. Virtual Tach **cannot** be reset with the Bitwriter.

Note: Virtual Tach cannot be used in MTS Manual Transmission Mode.

Virtual Tach handles disengaging the starter motor during remote starting – it does not address over-rev. If the customer wants to have the over-rev protection capability, now listed as optional in the owner's guide, the tach wire must be connected. This may involve more installation shop charges than initially quoted.

Important: If the Virtual Tach mode over cranks or doesn't crank the vehicle long enough to start and run the car, use the Bitwriter to add or subtract the starter output time. You can adjust the output time in increments of 50mSec of the learned time using the Bitwriter.

► Tach learning

To learn the tach signal:



1. Start the vehicle with the key.

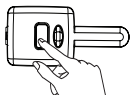

2. Within 5 seconds, press and hold the Valet/Program switch.



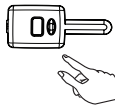

3. After 3 seconds the LED will light constant when the tach signal is learned.



4. Release the Valet/Program switch.

► Tach threshold On/Off

In most cases, this jumper can be left in the Off position. Some new vehicles use less than 12 volts in their ignition systems. The unit may have trouble learning the tach signal in these vehicles. Changing the jumper to the On setting changes the trigger threshold of the digital tach circuit so that it will work with these type vehicles.

TACH THRESHOLD OFF (DEFAULT) 
TACH THRESHOLD ON 



D2D Jumper settings

The security system has the ability to work with a compatible module through the D2D lines. There are two settings: one for using an internal docking module, (p/n 400N) or an external module.

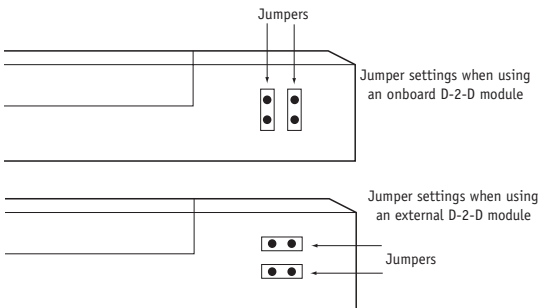

Setting the light flash polarity

Light flash (+) / (-) polarity

The internal fuse is used to determine the light flash output. In the (+) position, the onboard relay will output (+)12V on the WHITE wire, H1/11. In the (-) position, the on-board relay will supply a (-) output. When wiring into a multiplex circuit, you can replace the fuse with a resistor (paying attention to the polarity setting). (Refer to diagram on p.24, H1/4 White/ Brown wire description).

Note: For parking light circuits that draw 10 amps or more, the internal jumper must be switched to a (-) light flash output. P/N 8617 or a standard automotive SPDT relay must be used on the H1/11 light flash output harness wire.

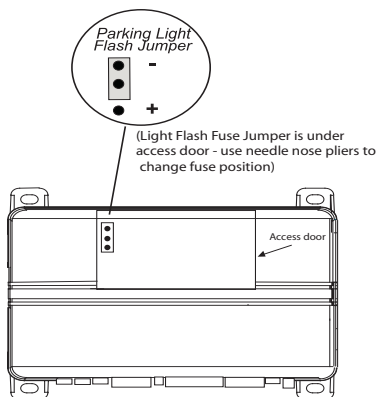

Remote control learn routine

The system comes with a 1-way and a 2-way remote control that are already programmed to the system. The system can store up to 4 different remote control codes in memory.

The remote uses a Supercode Protocol and requires setup before programming the system.

To enter the remote setup mode on the 1-way and 2-way remotes:

1. Hold the "function" button on the remote until you hear it emit a long beep. The transmit LED comes on solid (approximately 8 seconds).
2. Press and hold the "remote start" button until the remote beeps three times, and the amber Transmit LED lights up.
3. Next enter the remote control learn routine and choose the function for "auto learn configuration" listed on the program grid.

Note: You do not need to go through the setup for the other features in the menu.

After entering the setup mode on the remote, use the following learn routine to add remote controls to the system.

The learn routine may be locked if previously programmed using the Bitwriter®. If the honk generates one long chirp when attempting to program the unit, the learn routine is locked and must be unlocked using the Bitwriter® before proceeding.

The Valet/Program switch, plugged into the blue port, is used for programming. There is a basic sequence to remember whenever programming this unit: Door, Key, Choose, Transmit and Release.



1. Insert the key. Turn the ignition to the ON position. The heavy gauge pink wire must be connected.



2. Choose. Within 10 seconds, press and release the Program switch corresponding to the number of the desired function step listed in the following table.

Once you have selected the function step, press the switch once more and hold it. The LED flashes and the horn honks to confirm the selected functional step. Do not release the Program switch.

Step	Function
1	Auto Learn Standard Configuration (default) The auto learn configuration will automatically setup the remote button configuration. Note: Due to the Supercode protocol, you cannot change the configuration.
2	Delete remotes: This feature will erase all remotes from the memory of the system. This is useful in cases when a customer's remote is lost or stolen. Note: Does not reset the programmed features of the system or reset the Virtual Tach setting.
3	Reset Features: This resets all the features of the system to the factory default settings. Note: Does not delete the remotes from the system or reset the Virtual Tach setting.
4	Virtual Tach Reset: Deletes all previously learned values for Virtual Tach, and on the next remote start sequence the unit will begin virtual tach initialization. Note: The "Zap" feature on the Bitwriter does not reset the Virtual tach setting.



4. Transmit. While holding the Valet/Program switch, press the  button on the remote control. The horn honks to confirm that the code has been successfully programmed. It is not possible to teach a remote control button to the system more than once.

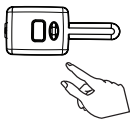

5. Release. Once the code is learned, the Valet/Program switch can be released. You can advance from one function step to another by releasing the Valet/Program switch and tapping it to advance function steps and then holding it.

Learn Routine is exited if:

- The ignition is turned off
- The program switch is pressed too many times
- More than 30 seconds elapses between steps

Remote control configuration

➤ Responder LE 2-way

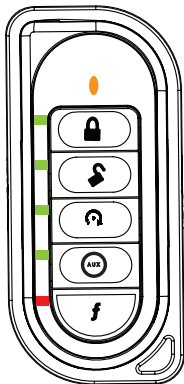





Note: The one-way remote only has the transmit LED and will not give any confirmation tones.

Note: If Keypad Lock is On, press **f** and then press **🔒** to exit.

The remote control buttons that operate the features of the remote start system are described below. The buttons will operate in this configuration when the remote control is programmed using the Step 1 Auto-learn routine.

For more information about the remote control functions, see the Owners Guide.

Level Button	Direct Access	f x 1	f x 2	f x 3	f x 4
	Lock	Silent Lock			
	Unlock	Silent Unlock	Valet Mode	Car Finder	
	Remote Start	Reset Runtime	Timer Mode	Smart Start	Rear Defogger
	Trunk Release	AUX 1	AUX 2	AUX 3	
	Function Shift	Cabin Temperature request (2-way only)	Lock Status (2-way only)	Runtime Check (2-way only)	

Important: To access "Cabin temperature request, Lock status, and Runtime check, press the "F" button the specified amount of times, and then hold.

System features learn routine

The System Features Learn Routine dictates how the unit operates. It is possible to access and change any of the feature settings using the Valet/program switch. However, this process can be simplified by using the Bitwriter®. Any of the settings can be changed and then assigned to one of four remote controls. This feature is called Owner Recognition. Each time that particular remote control is used to disarm the system, the assigned feature settings will be recalled. Owner Recognition is only possible when programming the unit via the Bitwriter®.



If programming with the Bitwriter®, the learn routine can be locked or unlocked. If the learn routine has previously been locked, it must be unlocked with Bitwriter® - this cannot be done manually with the Valet switch.



1. Ignition. Turn the ignition on, then off. (The heavy gauge PINK wire must be connected.)



2. Select a Menu. Press and HOLD the Valet/Program switch. (The Valet/Program switch must be plugged into the blue port.) After three seconds the LED flashes and horn honks one-time, indicating entry to the Basic Features Menu. If this is the menu you want, release the button and go on to Step 4.

If the button is not released, the program jumps to the next menu, the LED flashes and the horn honks twice. There are three possible menus. Select the menu you want, then release the Valet/Program switch.

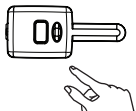

3. Select a Feature. Press and release the Valet/Program switch the number of times corresponding to the feature you wish to change. For example, to access the third feature, press and release 3 times. Then press the button once more and HOLD it. The LED flashes and horn honks the number of times equal to the feature you have accessed.

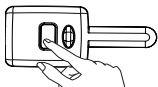

4. Program the Feature. While holding the Valet/Program switch, you can toggle the feature on and off using the remote control. Pressing the button that locks the system selects the one-honk or default setting. Pressing the button that unlocks the system will select the two-honk setting.

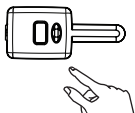

5. Release. Valet/program switch.

Note: Some features have more than two possible settings. Pressing  or  will toggle through the two-honk and higher settings.

Once a feature is programmed:

- Other features can be programmed within the same menu
- Another menu can be selected
- The learn routine can be exited if programming is complete

To access another feature in the same menu:

1. Press and release the Valet/Program switch the number of times necessary to advance from the feature you just programmed to the next one you want to program.
2. Then press the Valet/Program switch once more and hold it.

For example, if you just programmed the third feature in the menu and you want to program the seventh feature in the menu, press and release the Valet/Program switch four times and then press it once more and hold it. The LED flashes and the horn honks seven times to confirm access to the seventh feature.

To select another menu:

1. Press and hold the Valet/Program switch.
After three seconds, the unit will advance to the next menu, the LED flashes and the horn honks, indicating which menu has been accessed.

If you just programmed features in the first menu and you want to program a feature in the third menu, press and hold the Valet/Program switch. After three seconds the LED flashes and the horn honks twice indicating access to the second menu. Continue to hold the button and three seconds later the LED flashes and the horn honks three times indicating access to the third menu.

Features in the third menu are then programmable following steps 4 through 6 of the System Features Learn Routine procedure.

The learn routine will be exited if any of the following occurs:

- The ignition is turned On
- There is no activity for 30 seconds
- The Valet/Program switch is pressed too many times

Feature menus

► Menu 1 - Keyless entry

Default settings are indicated in bold type.

Menu Item	Feature	Opt. 1	Opt. 2	Opt. 3	Opt.4	Opt. 5+
1	System Locking	Active locking	Passive locking	Auto relocking		
2	Panic Mode	On	Ign Off only	Off		
3	Horn function	Confirmation honk (20mS) & panic	Confirmation honk (30mS) & panic	Confirmation honk (40mS) & panic	Confirmation honk (50mS) & panic	Confirmation honks Off, Panic only
4	Ign-controlled locks	No Ign-locking	Lock & Unlock	Lock Only	Unlock Only	
5	DoorLock Pulses	Single	Double Unlock Only	Double Lock Only	Double Lock & Unlock	
6	DoorLock Output Duration	0.8sec	3.5 sec	0.4 sec		
7	2nd Unlock	No 2nd unlock	2nd unlock on Ign-control after first unlock	2nd unlock on Ign-control with first unlock		
8	Comfort Closure	No Comfort Closure	Comfort Closure 1	Comfort Closure 2		
9	Hood Trigger Type	Normally Open	Normally closed			

► Menu 2 - Convenience

Menu Item	Feature	Opt. 1	Opt. 2	Opt. 3	Opt.4	Opt. 5+
1	Onetime Bypass	On	Off			
2	Valet Switch Pulse Count	1	2	3	4	5
3	Door ajar Error honk	On	Off			
4	Ign-controlled Dome light	On	Off			
5	OEM Alarm Disarm w/ Ch2	On	Off			
6	OEM Alarm Disarm Output	With Unlock	Before Unlock	Remote Start Only		
7	OEM Alarm Disarm Pulses	1	2			
8	Aux 1 Output type	Validity	Latch	Latch/reset/ign	Timed 30 secs	Off
9	Aux 1 Linking	No Linking	Link to Arm	Link to Disarm	Link to Arm/disarm	Link to Remote Start only
10	Aux 2 Output type	Validity	Latch	Latch reset/ign	Timed 30 secs	Off
11	Aux 2 Linking	No Linking	Link to Arm	Link to Disarm	Link to Arm/Disarm	Link to Remote Start only
12	Aux 3 Output type	Validity	Latch	Latch reset/ign	Timed 30 secs	Off
13	Aux 3 Linking	No Linking	Link to Arm	Link to Disarm	Link to Arm/Disarm	Smart Key Control (Link to Remote Start Off)

► Menu 3 - Remote start

Menu Item	Feature	Opt. 1	Opt. 2	Opt. 3	Opt.4	Opt. 5
1	Transmission Mode	Manual	Automatic			
2	Engine Checking Mode	Virtual Tach	Voltage	Off	Tachometer	
3	Cranking Time	0.6 sec	0.8 sec	1.0 sec	1.2 sec	1.4 (5)/1.6(6)/1.8 (7) 2.0(8)4.0(9)
4	Remote Start Runtime	12 min	24 min	60 min		
5	Activation Pulse Count	1	2			
6	Turbo Mode	No Turbo Mode	On 1 min	On- 3 min	On 5 min	On 10 min
7	Timer Mode Runtime	12 min	3 min	6 min	9 min	
8	Flex Relay Function	Ignition 2	Accessory 2	Starter 2		
9	Diesel Start Delay	Wait-to Start input	Timed 15 sec	Timed 30 sec	Timed 45 sec	
10	Accessory during Diesel Start Delay	On	Off			
11	Status 2 Output	Status	Latch Rear Defogger	Pulse Rear Defogger		
12	Parking Light Output	Constant	Pulsed	Off		
13	Anti-grind Output	On	Off			
14	Tach Mode Starter Release	Normal	Increase	Decrease		
15	Vehicle temp auto report	Off	On			

Feature descriptions

The features of the system are described below. Features that have additional settings that can be selected only when programming with the Bitwriter® are indicated by the following icon: 

Default settings are in bold. The numbers in parentheses indicate the number of times the control center LED flashes.

► Menu 1 - Keyless entry

1-1 Active/Passive Locking/Auto-relocking: When active locking (1) is selected, the system only locks when the transmitter is used. When set to passive (2) the system automatically locks 30-seconds after the last door is closed. To alert the consumer of passive locking, the horn honks 20-seconds after the door is closed. This provides the consumer with an audible warning prior to the system actually locking. At the 30-second mark the system locks, but without the horn honk.

When Auto re-locking (3) is On, the system re-locks the doors 30 seconds after the system is unlocked when using the remote, and the doors on the vehicle have not been opened. If a door is opened when the re-lock timer is active, the auto re-lock feature is defeated until the system sees another unlock command from the remote.

Important: The optional door input must be connected for the ignition controlled lock feature to work.

1-2 Panic On: (1 LED flash) This feature controls whether or not the panic mode is available with the ignition on. In some states there are laws prohibiting a horn continually sounding in a moving vehicle. This feature makes the system compliant with these regulations. The LED flashes twice (2) to indicate Panic with ignition Off. When Panic is Off, the LED flashes (3)

1-3, Horn Function: Turns On/Off the confirmation honks when locking/unlocking. Use it to change the output pulse duration for vehicles that require a longer pulse for the horn to honk. Confirmation honks ON (20mS) & panic, (1) Confirmation honk (30mS) & panic, (2) Confirmation honk (40mS) & panic (3) Confirmation honk (50mS) & panic (4) Confirmation honks OFF, panic only (5). When choosing panic only; the horn will not sound when locking or unlocking, only when the panic feature is used.

1-4 Ignition Locks Off: (1) When turned Off the system does not lock/unlock the doors when the ignition is turned on. (2) Lock and Unlock. The doors lock three seconds after the vehicles doors are closed when the ignition is turned On, and unlock when the ignition is turned Off. (3) Lock: Locks the doors three seconds after the ignition is turned On and the vehicles doors are closed. (4) Unlock: Unlocks the doors when the ignition is turned off.

Important: The optional door input must be connected for the ignition controlled lock feature to work.

1-5 Single Pulse Lock/Unlock(1): The system sends out a single pulse when locking and unlocking. (2) Double-pulse unlock sends out 2 pulses when unlocking. (3) Double-pulse lock sends out 2 pulses when locking. (4) Double-pulse lock/unlock sends out 2 pulses when locking and unlocking.

1-6 0.8 sec Door Lock Pulse (1)Duration:The default setting is 0.8 second door lock pulses. Some European vehicles, such as Mercedes-Benz and Audi, require longer lock and unlock pulses to operate the vacuum pump. Programming the system to provide 3.5 second (2) pulses, accommodates the door lock interface in these vehicles. (See door lock connections section for wiring information regarding Type E door locks interfacing. The 0.4 second (3) pulse is required on some vehicles where the lock wires can also control the windows and the 0.8 second pulse causes the windows to open/close when locking or unlocking.

1-7 No 2nd Unlock Output (1): The second unlock output is defeated at all times. 2nd unlock On with ignition control, after first unlock turns on the 2nd unlock output and unlocks the passengers doors after the driver's door is unlocked with ignition controlled locks. (3) 2nd unlock on with ignition control with first unlock will turn on the 2nd unlock output and will unlock the passengers doors at the same time the driver door is unlocked with ignition controlled locks.

1-8 Comfort Closure Off(1): The system can be programmed to close the windows when the system is locked. If programmed ON, the lock output provides a 20 second pulse when the system is locked. The output will be cancelled if the unlock button is pressed. In the Off setting the system will not do this function.

(2) Comfort closure 1 - Activates the 20 second timer after the door lock pulse.

(3) Comfort Closure 2 - Activates the 20 second timer with the door lock pulse.

To test if the car has the comfort closure:

1. Insert the key into the drivers door key cylinder.
2. Turn the key to the lock position and hold for about 10 seconds. If Comfort closure is available, the windows (and in some cars the sunroof) will close.

Note: Some cars require that you turn the key once, release it, and then turn and hold into the lock position.

Important: Comfort closure can only be used on cars that have the capability of closing the windows (and on some cars the sunroof as well) with the key cylinder in the door.

1-9 Hood Trigger (Normally Open): Hood trigger (normally closed). To program the unit for either a normally open (rests open, or at 12v when the hood is closed) or a normally closed (rests at ground when the hood is closed) pin switch.

➤ Menu 2 - Convenience

2-1 One time bypass OFF: When programmed Off (1) the unit does not passively lock for one cycle when turning the ignition On and Off within 3 seconds. When going through this procedure the horn honks once indicating that One Time Bypass has been activated. One time bypass On (2), the system passively locks the vehicle 30 seconds after the ignition is turned off, and the door has been opened and closed.

Note: Default settings are in bold. The numbers in parentheses indicate the number of times the LED will flash.

2-2 Valet switch pulse count, 1 pulse. Optional starter kill emergency override. From valet, 2 - 5 pulses. The system can be programmed to count the number of presses of the valet switch before disabling the optional starter kill. The factory default setting is one pulse. The unit can also be set for two to five pulses.

2-3 Door trigger error notification: Door trigger error honk Off. When On (1) , this feature controls the error honk that is generated if the system is locked with the door trigger active. This is useful in vehicles with a long dome light delay after the door is closed. If the system is locked before the dome light turns Off, the system generates the door trigger error notification. If this error notification is not desired, use this feature to disable the door open error notification. If the error notification is turned Off, (2), no bypass horn is generated, even if a door is accidentally left open.

<p>Important: The optional door input has to be connected for manual transmission start to work.</p>

2-4 Ignition Controlled Dome Light Supervision On: If turned On (1), the system turns On the dome light for 60 seconds when the ignition is turned off. The optional dome light supervision feature must be installed as described in the Wire Connection Guide. Use the two-honk setting for: Ignition controlled dome light Off.

2-5 FAD w/channel 2 ON: FAD w/channel 2 OFF. In the default setting the factory alarm disarm output will disarm the factory alarm system any time the button controlling the trunk release output is pressed.

2-6 Factory Alarm Disarm-With Unlock, Before Unlock, Remote Start Only: In the default setting the factory alarm disarm output will disarm the factory alarm system any time the button controlling Unlock or Remote Start is pressed. The "Before Unlock" output will disarm the factory alarm before the unlock output activates and when remote start is activated. The "Remote Start Only" will disarm the factory alarm only when the remote start is activated.

2-7 FAD 1 pulse: FAD 2 pulses. This setting determines how many pulses the system will output on the Factory alarm disarm wire.

2-8 Aux 1 Validity (1) Latched (2), Latch reset w/ignition (3), 30-sec. timed (4)

- Validity: Output that will send a signal as long as the transmission is received.
- Latched: Output that will send a signal when the Aux 1 button is pressed and will continue until the same button is pressed again.
- Latched, reset with ignition: Similar to the latched output this output type turns ON the first time the Aux 1 button (1) is pressed and turns OFF the next the same button is pressed. This output type additionally stops and resets whenever the ignition is turned ON, and then OFF.
- 30-second timed: Output that will send a continuous signal for 30 seconds.
- Off: Output is disabled.

Note: All auxiliary channel timed outputs can be programmed using the Bitwriter® (1-90 seconds)

2-9 Aux 1 Linking, None (1) Lock (2) Unlock (3) Lock/Unlock (4) Remote Start (5). When programming to Validity or timed output this can be programmed to activate when locking or unlocking (or remote start) with the transmitter.

Note: Aux linking gives you option to have the auxiliary wire activate when locking, unlocking, locking and unlocking or with remote start.

2-10 Aux 2 Validity (1) Latched (2), Latch reset w/ignition (3), 30-sec. timed, (4) Output, (5) Off: Auxl 2 can be programmed for these output configurations. The unit is set to the default validity output. To change the configuration use the two-honk setting to toggle through the different configurations. Refer to feature 2-8 for additional details

2-11 Aux 2 Linking None (1) Arm (2) Disarm (3) Arm/Disarm (4) Remote Start (5). Refer to feature 2-9 for additional details.

2-12 Aux 3 Validity (1) Latched (2), Latch reset w/ignition (3), 30 -sec. timed, (4) Output, (5) Off: Aux 3 can be programmed for these output configurations. The unit is set to the default validity output. To change the configuration use the two-honk setting to toggle through the different configurations. Refer to feature 2-8 for additional details.

2-13 Aux 3 Linking None (1) Lock (2) Unlock (3) Lock/Unlock (4) Smart key control (link to remote start Off. (5). When aux 3 is programmed to Smart Key control, this wire outputs a 800ms pulse when the Remote Start is shut Off.

The system also monitors the door trigger input. When the door is opened during the remote start runtime, the remote start shuts down and this wire outputs the 800ms pulse.

Important: This wire is connected to the pushbutton wire that start and stops the car. It pulses the wire at the button to shut off the car when the remote start is deactivated.

➤ Menu 3 - Remote start

3-1 Manual Transmission Mode: This is the default setting. The two-honk setting is used for Automatic transmission mode. In the default setting the remote start unit is programmed to look for a shutdown procedure to activate the remote start.

Important: The optional door input has to be connected for manual transmission start to work.

3-2 Engine Checking Virtual Tach: (1) When set to "virtual tach" (1) the remote start monitors the cranking voltage of the vehicle and sets it as a reference point. Fifteen seconds after the crank output sequence the remote start checks the voltage again to determine if the vehicle is running.

When set to voltage, (2) the unit cranks the starter for the programmed time and then attempts to sense that the engine is running by detecting an increase in voltage. If programmed Off (3) the vehicle cranks for the programmed crank time. The tach setting or voltage setting is not checked to verify that the car is running. In the OFF setting, if the vehicle fails to start, the ignition stays on for the run duration. Using tach or either of the voltage settings is recommended.

When set to Tachometer, (4) the unit references the learned tach signal to disengage the starter. In addition it will monitor the RPM and shut down if the engine RPM is too high or too low.

Important: The tach wire must be connected and programmed for the manual transmission mode to work.

3-3 Crank Time 0.6 0.8 (2) 1.0 (3) 1.2 (4) 1.4 (5) 1.6 (6) 1.8 (7) 2.0 (8) 4.0 (9) SECONDS: If the unit is programmed for no engine checking or voltage sense, the crank time must be set to the appropriate duration. The default setting is 0.6 second and the LED will flash once. If a different crank time is desired, toggle through the higher settings by using the two-honk settings.

3-4 Run Time 12 (1), 24 (2) 60 (3) MINUTES:  Selects the time in minutes that the system will operate the engine until the system “times out”. The system may be shut down using the remote or any of the shutdowns at any time. Using the Bitwriter®, the run time can be programmed for any duration from 1-60 minutes.

3-5 Activation Pulse One: This allows the system to use 1 or 2 pulses to activate the remote start sequence. The default setting is 1-pulse.

Note: This setting affects both the input wire and the remote control.

3-6 Turbo Mode: The factory default is OFF (1). On 1 min (2), On 3 min (3) On 5 min (4) On 10 min (5): In the Off setting the turbo mode does not function. In the On and timed setting, the remote start can be used as a turbo timer. The car remains running for the programmed runtime, and the ignition is turned Off.

Important: For this feature to work the tachometer wire on the remote start needs to be connected and programmed.

3-7 Timer Mode Run Time—12min (1):  This is the default setting. Selects the time in minutes that the system will operate the engine until the system “times out” when the remote start activates in timer mode. Use the two-honk setting for 3(2), 6 (3), 9 (4) MINUTES: This is the maximum operation period and the system may be shut down using a shutdown at any time. Using the Bitwriter®, the run time can be programmed for any duration from 1-16 minutes.

Note: Default settings are in bold. The numbers in parentheses indicate the number of times the LED will flash.

3-8 Flex Relay Function: Ignition 2 (1) In the factory setting, the flex relay will function the same as the pink ignition 1 wire, in accessory setting the flex relay will function the same as the Orange accessory 1 wire, in starter setting the flex relay will function the same as the purple starter 1 wire.

3-9 Diesel Timer—Wait-To-Start Input - Timed 15, 30, 45 SECONDS:  Default is the "Wait-to-Start" input control wire, or programmable to ignore the input control wire by a delay of 15 (2), 30 (3), or 45(4) seconds. This feature can also be optionally programmed with the Bitwriter®, with a delay from 1 to 90 seconds.

3-10 Accessory State During Wait-To-Start On: This feature will allow the selection of the accessory output to be ON or OFF during wait-to-start. Use the two-honk setting for OFF.

3-11 2nd Status Output: Normal: This feature will allow selection of status output or a rear defogger mode that turns on ten seconds after the vehicle has started if the vehicle interior temperature is below 55 degrees F. The defogger mode has two selections, latched, the LED will flash twice, or pulsed, the LED will flash three times. Latched mode will only stay on for 10 minutes.

Note: When the defogger mode is on, the output will always be active and can be turned on independently with the remote for a one-time activation. (See the Remote Functions table.)

3-12 Parking Lights Constant: In the default setting, the parking lights (if connected) will come on solid during the remote start runtime. In the two- flash setting the parking lights will flash during the remote start runtime. In the OFF setting, the parking lights will not come ON or flash, when the vehicle is remote started.

3-13 Anti-Grind On: With the anti-grind On (default) the ground-when-armed output will be active during remote start operation. This activates the optional starter kill relay and prevents the customer from re-cranking the car with the key, when doing key takeover. If accessories such as a voice module or window module are added to the unit, it may be necessary to use the two-honk setting to program this feature OFF.

3-14 Tach Mode Starter Release: Normal:  Use the two-honk setting to increase time by 15% of the original tach programmed time. The LED will flash twice (2). To decrease by 15% of the original programmed time, the LED will flash three (3) times.

3-15 Vehicle temperature auto report ON or OFF. The default setting is OFF. When programmed ON the main unit will store the interior temperature of the vehicle in its temporary memory. When the vehicle's interior temperature changes 1 degree Celsius, the main unit automatically sends the interior temperature message to the remote and the LED's light up accordingly to display the current temperature. (See Owner's Guide for temperature description.)



The Bitwriter®  has the ability to fine tune certain features of the system. These features and the adjustments that may be programmed are described in the table that follows.

Note: Feature programming for Responder LC remote controls with a display screen are available when using the Bitwriter, however these features **do not** apply to this LE system.

Feature	Default setting	Optional settings
Aux 1 timed output	30 seconds	1-90 seconds
Aux 2 timed output	30 seconds	1-90 seconds
Aux 3 timed output	30 seconds	1-90 seconds
Diesel start timer	15 seconds	1-90 seconds
Timer mode run time	12 minutes	1-16 minutes
Timer mode starts	6 starts	1/2/3/4/ 6 /8/10/12/14/16/ 18/20/22/24 (Starts)
Timer mode intervals	3 hours	1/2/ 3 /4/6/8/10/12/14/16/ 18/20/22/24 (Hours)
Smart start low temp	0 (F)	OFF/-20/-10/ 0 /10/20/30/40/50/ 60/70 (F)
Smart start high temp	100 (F)	OFF/40/50/60/70/80/90/ 100 / 110/120/130 (F)
Smart start low battery	10.5 volts	OFF/12.5/12/11.5/11/ 10.5 /10/ 9.5/9 volts
Tach mode starter release	10 (normal)	0/1/2/3/4/5/6/7/8/9/ 10 /11/1 2/13/14/15/16/17/18/19/20
Virtual tach fine tune	Not initialized	0 - 1 second in 50mS increments
Feature programming	Unlocked	locked
Transmitter programming	Unlocked	locked
Remote start runtime	12 minutes	1-60 minutes

Valet mode

To enter or exit valet mode with the valet/program switch:



1. Turn the ignition key on and then off.

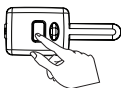

2. At anytime during the next 10 seconds, press and release the Valet switch. Now the Status LED will light constantly if you have entered Valet® Mode, and go out if you have exited Valet Mode.

To enter or exit Valet mode with the remote control:

Press **f** two times, and then  to put the system into or out of Valet Mode. The unlock LED flashes and the remote beeps once indicating entry into Valet mode. Repeating the process takes the system out of Valet Mode. The unlock LED flashes and the remote beeps twice.

Note: The system's LED will come on solid when in Valet Mode and will shut off when exiting Valet Mode.

When locking the system in Valet Mode, the Lock and Function LEDs light for one second and emit an error tone. When unlocking in Valet Mode, the Lock and Function LEDs light for one second and emit 2 error tones.

Remote starting the vehicle

Before using the remote start be sure the vehicle is parked in a safe area with proper ventilation.

To remote start the vehicle:

- Press the  button on the remote control. The vehicle parking lights flash.
- On the 2-way remote, the Remote Start LED flashes and ascending Remote Start tone plays.

The preset remote start run time is 12 minutes. This can be changed to between 12 and 60 minutes.

The system has a feature, if programmed On, that automatically notifies you when the runtime is running low. When the system reaches 3-minutes of runtime remaining, it sends the 2-way remote control a paging signal. The 2-way beeps one-time, plays the error beep tone one-time, and then the  and **f** LEDs flash.

To activate Valet-take over:

1. Before turning the engine Off, press and release the (RS icon) button within 3 seconds. Then wait a few seconds.
2. Turn the ignition key to the Off position.
3. Exit the vehicle and lock the doors with the remote.
The engine remains running until the programmed time elapses or a shut-down input is received.

Points to remember

If the hood is open or if the brake pedal is pressed, the vehicle will not remote start. **The remote start shuts down:**

- When the brake pedal is pressed
- The hood is opened
- When the remote start command is sent again from a remote control
- When runtime expires

Manual transmission remote start

If the vehicle has a manual transmission the proper steps must be followed before leaving the parked vehicle or the remote start feature is disabled.

1. Make sure the engine is running and the doors on the vehicle are closed.
2. Put the transmission in neutral.
3. Press on the brake in the vehicle.
4. Apply the emergency brake.
5. Release the brake.
6. Within 15 seconds activate the remote start from the remote.
7. The parking lights will flash 5-times confirming that the remote start is active. If the parking lights do not flash 5-times, then repeat steps 1 - 6.
8. Turn off the ignition (the car stays running when key is turned off).
9. Exit the vehicle.
10. Lock the system. (the vehicle shuts off when locking the system).

You can now remote start the vehicle. If a door is opened before the next remote start activation the system will not remote start.

Note: To enable Valet take-over with a manual transmission, open the door and enter into manual transmission mode, as described above. The parking lights flash one-time when entering Valet take-over. Once you exit the vehicle you can lock the system and the car will remain running. If the vehicle shuts down when locking, then the unit did not enter valet take-over mode.

Timer mode

This unit can be programmed to start and run the engine every three hours, for a maximum of six cycles. The engine will run for the programmed run time and then shut down. After three hours, the system will restart the engine.

Important: Use Timer Mode in open areas **only**. Never start and run the vehicle in an enclosed space such as a garage or carport.

To activate timer mode with an automatic transmission:

1. Remote start the vehicle by pressing **f** twice and then press .
2. The parking lights flash rapidly four times to confirm timer mode entry. (The vehicle will not remote start at this point.)
3. The vehicle begins the timer mode sequence.

To activate timer mode with a manual transmission:

1. Enter the MTS mode.
2. Exit the vehicle and lock the system.
3. Enter the timer mode. The parking lights quickly flash 4 times to confirm entry into timer mode (vehicle will not remote start at this point).
The vehicle begins the timer mode sequence.

Timer Mode is exited automatically after the sixth run cycle. The parking lights slowly flash 4 times when exiting timer mode.

To exit timer mode with the transmitter:

- Press the **f** button twice and then press . The parking lights flash slow four times to confirm timer mode is exited.

To exit timer mode without the transmitter:

1. Make sure the remote start system is not operating the engine.
2. Turn the ignition on. Timer Mode is exited and the parking lights flash slowly four times.

Note: The Bitwriter can change the amount of times the remote start activates and, it can change the intervals between activations in timer mode.

To activate turbo timer mode:

1. Make sure turbo timer is turned on. See (Feature Menu 3, #6)
2. Open the vehicle door.
3. While the vehicle is running, press **f** button 2-times, and then press  button. The parking lights flash one-time and the remote sounds the activation tone confirming that the remote start is activated.

Note: The 1-way remote only flashes the parking lights and does not emit any sounds.

4. Turn off the ignition. The car remains running.
5. Exit the vehicle and lock the system. The vehicle remains running for the programmed runtime.

To activate turbo timer mode with a manual transmission:

1. Perform the manual transmission procedure (See p.81), with the door open.
2. To transmit the timer mode feature with the remote, press **f** two-times, and then .
3. After exiting the vehicle, lock the system and the vehicle remains running for the programmed runtime. (The remote start feature is still enabled).

You can still remote start the vehicle after the turbo timer has timed out and shut off the vehicle. For safety reasons, if a door is opened while the system is locked or unlocked, the remote start exits the manual transmission mode and will not remote start until the MTS sequence is re-initiated.

Note: An optional push button can be hard wired to the (-) activation input of the system to activate turbo timer manually.

When the vehicle is running follow the procedures listed above, but instead of pressing the remote, press the push button the appropriate number of times to activate the remote start (factory setting is for 1 pulse). The remote emits the remote start confirmation tone, after which you can turn off the ignition and exit the vehicle. The car remains running for the pre-programmed amount of time.

Shutdown diagnostics

To perform shutdown diagnostics:

1. With the ignition OFF, press and hold the Valet/Program switch.
2. Turn the ignition ON and then back OFF while holding the Valet/Program switch.
3. Release the Valet/Program switch.
4. Press and release the Valet/Program switch. The LED flashes on the control center to report the last shutdown for one minute or until the ignition is turned on, as shown in the following table:

LED Flashes	Shutdown Mode
1	Runtime expired
2	Over-rev shutdown
3	Low or no RPM
4	Transmitter shutdown (or optional push button)
5	(+) Brake shutdown
6	(-) Hood shutdown
7	Timer mode/Turbo mode/Manual mode error *
8	Neutral safety shutdown
9	Low battery (voltage mode)

- 10
- 11
- * Timer mode error: Ignition is on or shutdown input is active when activating timer mode.

Turbo mode error: Turbo mode is programmed off, engine is not on or shutdown input is active.

Manual mode error: MTS not enabled.

Remote starting diagnostics

When the remote start function is activated and the 2-way remote emits an error tone, you can determine the cause of the no-start situation by counting the number of parking light flashes from the vehicle.

Parking Light Flashes

- | | |
|---|--|
| 5 | Brake wire is active |
| 6 | Hoodpin wire is active |
| 7 | Manual transmission mode is enabled and not initialized. |
| 8 | Neutral safety wire has no ground or the neutral safety switch is Off. |

Remote start safety check

Before vehicle reassembly, the remote start system must be checked to ensure safe and trouble-free operation. The following test procedure must be used to verify proper installation and operation of the system. The installation must be completed before testing, including connection to the brake switch and hood switch.

1. Test the BRAKE shutdown circuit: With the vehicle in Park (P), activate the remote start system. Once the engine is running, press the brake pedal. The engine should shut down immediately. If the engine continues to run, check the brake circuit connection.
2. Test the HOOD PIN shutdown circuit: With the vehicle in Park (P), open the hood. Activate the remote start system. The vehicle should not start. If the starter engages, check your hood pin and connections.
3. Test the NEUTRAL SAFETY shutdown circuit.

<p>Important: Make sure there is adequate clearance to the front and rear of the vehicle before attempting this test.</p>
--

4. Make sure the hood is closed and no other shutdown circuits are active.
 5. Set the emergency brake.
 6. Turn the ignition key to run position but do not start the engine.
 7. Put the vehicle in Drive (D).
 8. Put your foot over the brake pedal but do not press down on it. Be ready to step on the brake to shutdown the remote start system.
 9. Activate the remote start system.
- If the starter engages, immediately step on the brake to shut down the system. If it does engage, recheck the neutral safety input connection. The vehicle may use a mechanical neutral safety switch. (See H3/1 BLACK/WHITE neutral safety switch input in Remote Start Harness Wire Connection Guide section of this guide.)
 - If the starter does not engage, the test is complete. Once the system passes the tests, the vehicle can be re-assembled and delivered. Do not use the remote start system or finalize the installation if it fails any of the safety check tests.

Troubleshooting

► Keyless entry system

- **System will not passively lock until it is remotely locked and then unlocked:**

Are the door inputs connected? Is the H1/6 blue wire connected to the door trigger wire in the vehicle? Either the H1/5 green or the H1/7 violet should be used instead. (See wiring diagrams.)

- **The Valet/Program switch doesn't work.**

Is it plugged into the correct socket? See Plug-In LED and Valet/Program Switch section of this guide.

- **Status LED doesn't work.**

Is it plugged in? (See Plug-In LED and Valet/Program Switch section of this guide.) Is the LED plugged into the correct socket?

- **Door locks operate backwards.**

This unit has easily-reversed lock/unlock outputs. Recheck wire connections to see if you have reversed these.

► Remote start

- **The remote start will not activate**

1. Check remote startup diagnostics to determine what may be the cause of the no start situation.
2. Check the harnesses and their connections. Make sure that the harnesses are completely plugged into the remote start module. Make sure there are good connections to the vehicle wiring.
3. Check voltage and fuses on the main 12-pin harness and on the heavy gauge remote start harness.

- **The remote start will activate, but the starter never engages.**
 1. Check for voltage on the purple starter wire two seconds after the remote start becomes active. If there is voltage present, skip to Step 4. If there is not voltage present, advance to Step 2.
 2. Check the 30A fuses.
 3. If the gray/black wait-to-start wire is detecting ground upon activation, the starter will not crank.
 4. Make sure the purple starter wire is connected on the starter side of the optional starter kill/anti-grind relay.
 5. Does the vehicle have an immobilizer? Some immobilizer systems will not allow the vehicle to crank if active.
 6. Check connections. The heavy gauge remote start input wires on the heavy gauge 10-pin connector should have a solid connection. "T-taps" or "scotch locks" are not recommended for any high current heavy gauge wiring.

- **The vehicle starts, but immediately dies.**
 1. Does the vehicle have an immobilizer? The vehicle's immobilizer will cut the fuel and/or spark during unauthorized starting attempts.
 2. Is the remote start programmed for virtual tach voltage sense? If so, the crank time may not be set high enough. Voltage sense will not work on some vehicles.
 3. Check diagnostics. Sometimes a shutdown will become active during cranking or just after cranking.

- **The vehicle starts, but the starter keeps running.**
 1. Is the system programmed for engine checking off or virtual tach voltage sense? When programmed for either of these features, the engine cranks for the pre programmed crank time regardless of how long it takes for the vehicle to actually start. Adjust to a lower cranking time.
 2. Was the Tach Learn successful? The LED must light solid and bright to indicate a successful learn.
 3. Make sure that there is a tach signal at the purple/white tach input wire of the remote start. If there is not a tach signal, recheck the connection to the vehicle's tach wire and make sure the wire is not broken or shorted to ground leading to the remote start.

- **The vehicle starts, but will only run for 10 seconds.**
 1. Is the remote start programmed for voltage sense? If this does not work, a tach wire should be used.
 2. Check shutdown diagnostics.
- **The climate control system does not work while the unit is operating the vehicle.**

Either the wrong accessory wire is being energized or more than one ignition or accessory wire must be energized in order to operate the climate control system.
- **Manual Transmission Start diagnostics**

When enabling MTS, if you get a failure notification from the remote or the vehicle fails to remain started when you shut off the key, check for following:

 - Hood Open (gray wire)
 - Foot Brake active (brown wire)
 - No Parking Brake input-Black/white neutral safety wire not showing ground with parking brake set.
 - Tach not hooked up or programmed
 - Toggle switch not installed or not in the ON position.

Designed and Engineered in the USA

Directed[®]
E L E C T R O N I C S

N4202V 2008-06

Vista, CA 92081

www.directed.com

© 2008 Directed Electronics—All rights reserved