



Model 3300L

Installation guide



NOTE: This product is intended for installation by a professional installer only! Any attempt to install this product by any person other than a trained professional may result in severe damage to a vehicle's electrical system and components.

Code Hopping®, Doubleguard®, ESP®, FailSafe®, Ghost Switch®, Learn Routine™, Nite-Lite®, Nuisance Prevention® Circuitry, NPC®, Revenger®, Silent Mode™, Soft Chirp®, Stinger®, Valet®, Vehicle Recovery System®, VRS®, and Warn Away® are all Trademarks or Registered Trademarks of Directed Electronics

www.directechs.com

Technical Support 800-753-0800

These resources are for authorized Directed Dealer use only.

table of contents

what is included	4
primary harness (H1) wire connection guide	4
door lock harness (H2) wire connection guide	9
identifying the door lock system	9
at the switch	10
type A: positive-triggered, relay-driven system	11
type B: negative-triggered, relay-driven system	12
type C: reversing polarity system	13
type D: adding one or more after-market actuators	14
type E: electrically-activated vacuum	15
type F: one-wire system (cut to lock, ground to unlock)	16
type G: positive (+) multiplex	17
type H: negative (-) multiplex	19
auxiliary harness (H3) wire connection guide	20
starter interrupt harness (H4) wire connection guide	22
plug-in LED and valet/program switch	23
internal programming jumper	24
light flash jumper	24
on-board dual stage impact sensor	25
bypassing sensor inputs	25
transmitter/receiver learn routine	26
4-button transmitter configuration	27
LCD 2-way transmitter additional controls	28
system features learn routine	29
features menu	30
feature descriptions	30
nuisance prevention[®] circuitry[™]	32
table of zones	33
troubleshooting	33
wiring quick reference diagram	35

what is included

- Control module
- Plug-in LED system status indicator
- An on-board dual zone impact sensor
- 12-pin primary harness
- 3-pin auxiliary harness
- Plug-in 544N transceiver
- One 4-button remote transmitter
- One 5-button 2-way LCD remote transmitter
- Plug-in Valet/Program switch
- High-powered siren
- 7-pin door lock harness
- Plug-in starter interrupt harness

primary harness (H1) wire connection guide

H1/1	RED/WHITE	(-) 200 mA CHANNEL 2 VALIDITY OUTPUT
H1/2	RED	(+)12V CONSTANT POWER INPUT
H1/3	BROWN	(+) SIREN OUTPUT
H1/4	YELLOW	(+) IGNITION INPUT, ZONE 5
H1/5	BLACK	(-) CHASSIS GROUND INPUT
H1/6	VIOLET	(+) DOOR TRIGGER INPUT, ZONE 3
H1/7	BLUE	(-) MULTIPLEX TRIGGER INPUT, ZONE 1
H1/8	GREEN	(-) DOOR TRIGGER INPUT, ZONE 3
H1/9	BLACK/WHITE	OUTPUT OF INTERIOR LIGHT ILLUMINATION RELAY #30
H1/10	WHITE/BLUE	(-) 200 mA CHANNEL 3 VALIDITY OUTPUT
H1/11	WHITE	(+/-) SELECTABLE LIGHT FLASH OUTPUT
H1/12	ORANGE	(-) 500 mA GROUND-WHEN-ARMED OUTPUT

H1/1 RED/WHITE channel 2, (-) 200mA output

When the system receives the code controlling Channel 2, for longer than 1.5 seconds, the red/white wire will supply an output as long as the transmission continues. This is often used to operate a trunk/hatch release or other relay-driven function.

IMPORTANT! Never use this wire to drive anything but a relay or a low-current input! The transistorized output can only supply 200 mA of current. Connecting directly to a solenoid, motor, or other high-current device will cause it to fail.

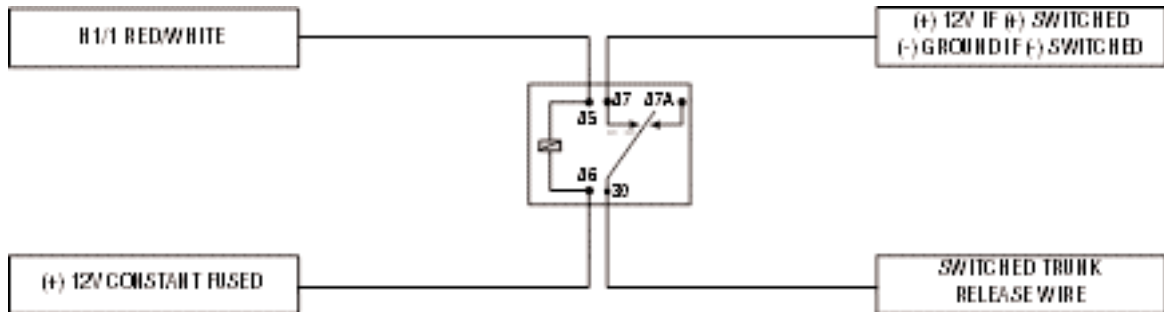

H1/2 RED (+) 12V constant power input

Before connecting this wire, remove the supplied fuse. Connect to the positive battery terminal or the constant 12V supply to the ignition switch.

NOTE: Always use a fuse within 12 inches of the point you obtain (+)12V power. Do not use the 15A fuse in the harness for this purpose. This fuse protects the module itself.

H1/3 BROWN (+) siren output

Connect this to the red wire of the siren. Connect the black wire of the siren to (-) chassis ground, preferably at the same point you connect the control module's black ground wire.

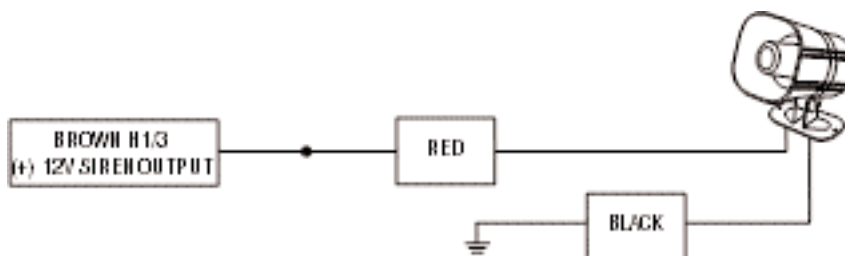

H1/4 YELLOW (+) ignition input, zone 5

Connect this wire to an ignition source. This input must show (+)12V with the key in run position and during cranking. Make sure that this wire cannot be shorted to the chassis at any point. This wire will report Zone 5.

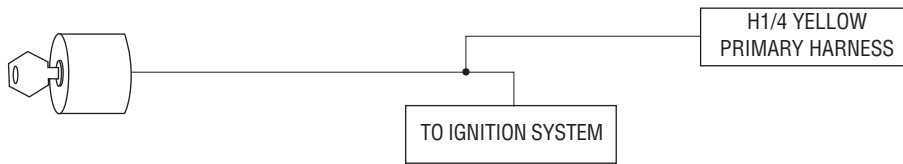

H1/5 BLACK (-) chassis ground connection

Remove any paint and connect this wire to bare metal, preferably with a factory bolt rather than a screw. (Screws tend to strip or loosen with time.) We recommend grounding all components, including the siren, to the same point.

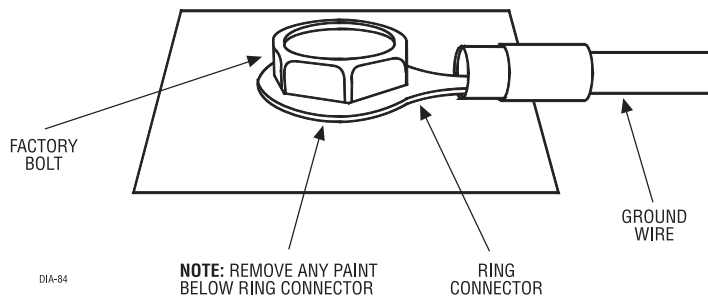

H1/6 VIOLET (+) door trigger input, zone 3

This wire is used in vehicles that have a positive (+) switched domelight circuit. Connect the violet wire to a wire that shows (+)12V when any door is opened, and ground when the door is closed. This wire will report Zone 3.

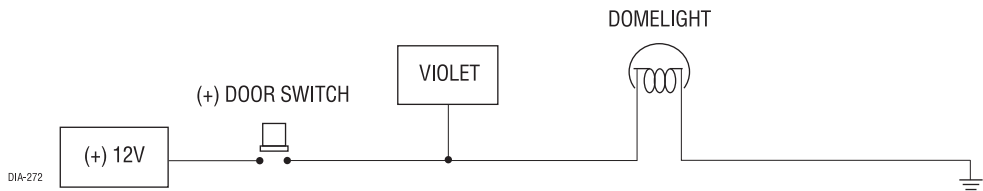

H1/7 BLUE (-) multiplex trigger input, zone 1

This wire will respond to a negative input with an instant trigger. Inputs shorter than 0.8 seconds will trigger the Warn Away response, while triggers longer than 0.8 seconds will instantly trigger the full alarm cycle. This wire is ideal for hood and trunk pins and will report on Zone 1. This wire can also be used with Directed Electronic's 506T Glass Breakage Sensor, as well as other Directed Electronic's single stage sensors. The H1/7 BLUE multiplex trigger wire can be used to shunt sensors during operation, using the auxiliary channels. When any of the auxiliary channels are transmitted, the H1/7 BLUE wire monitors for a ground. If ground is detected within 5 seconds of transmission, the sensors and the multiplex trigger input on the BLUE wire will be shunted until 5 seconds after the ground is removed. This allows the customer to access the trunk, remote start the vehicle, or roll the windows down without first disarming the alarm. (See *Bypassing Sensor Inputs* section of this guide.)

H1/8 GREEN (-) door trigger input, zone 3

Most vehicles use negative door trigger circuits. Connect the green wire to a wire which shows ground when any door is opened. In vehicles with factory delays on the domelight circuit, there is usually a wire that is unaffected by the delay circuitry. This wire will report Zone 3.

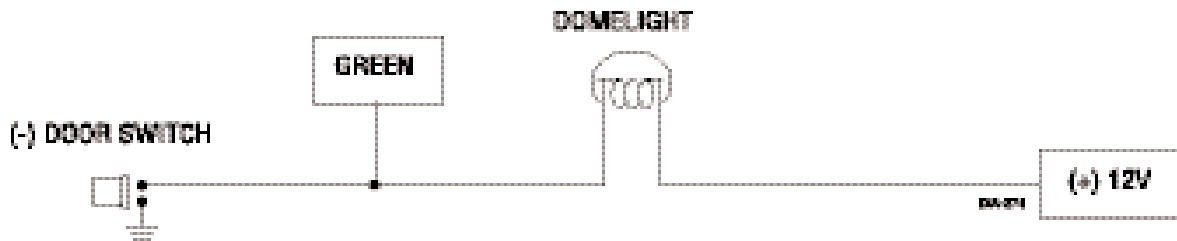

H1/9 BLACK/WHITE high current output from on-board interior light illumination relay

Connect this wire directly to the domelight circuit in the vehicle. The on-board relay will drive circuits up to 20 amperes. The polarity of this output is determined by the connection of the H2/G input wire in the Door Lock Harness.

NOTE: *If the H2/G input wire is not connected, there will be no output on this wire.*

H1/10 WHITE/BLUE (-) channel 3 output

When the system receives the code controlling Channel 3, the white/blue wire will supply an output as long as the transmission continues. Use for options such as **561T** Valet Start system, **529T** or **530T** power window controllers, etc.

IMPORTANT! *Never use this wire to drive anything except a relay or a low-current input! The transistorized output can only provide 200 mA of current, and connecting directly to a solenoid, motor, or other high-current device will cause it to fail.*

H1/11 WHITE (+/-) selectable light flash

As shipped, this wire should be connected to the (+) parking light wire. If the light flash polarity jumper inside the control module is moved to the opposite position (see *Internal Programming Jumper* section of this guide), this wire supplies a (-) 200 mA output. This is suitable for driving (-) light control wires in Toyota, Lexus, BMW, some Mitsubishi, some Mazda, and other model cars.

(+) Positive Light Flash Output

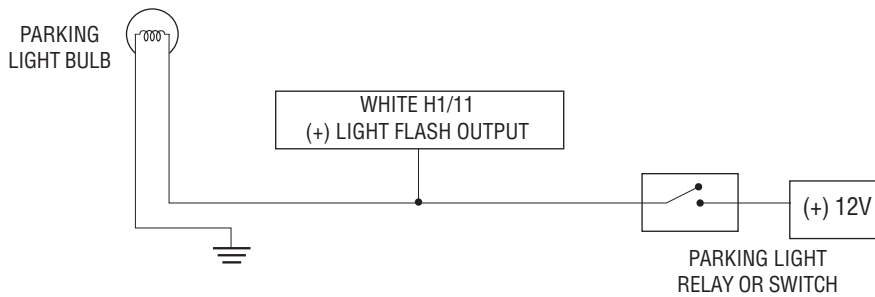

(-) Negative Light Flash Output

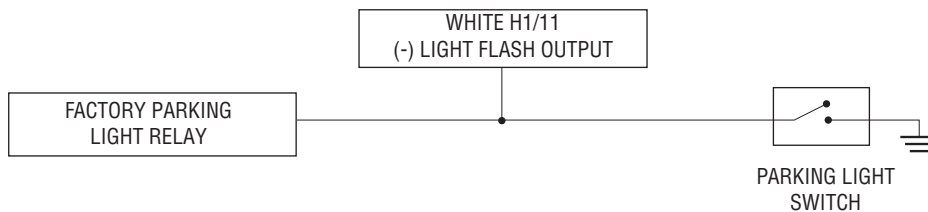

NOTE: For parking light circuits that draw 10 amps or more, the internal jumper must be switched to a (-) light flash output. (See the *Internal Programming Jumper* section of this guide.) **P/N 8617** or a standard automotive SPDT relay must be used on the H1/11 light flash output harness wire.

H1/12 ORANGE (-) ground-when-armed 500 mA

This wire supplies (-) ground as long as the system is armed. This output ceases as soon as the system is disarmed. This wire can be used to turn on an optional sensor or to control an optional accessory, such as a window module or pager.

door lock harness (H2) wire connection guide

H2/A	VIOLET*	LOCK RELAY, NORMALLY OPEN
H2/B	BLUE/BLACK	LOCK RELAY, COMMON
H2/C	BROWN/BLACK	LOCK RELAY, NORMALLY CLOSED
H2/D	VIOLET/BLACK*	UNLOCK RELAY, NORMALLY OPEN
H2/E	GREEN/BLACK	UNLOCK RELAY, COMMON
H2/F	WHITE/BLACK	UNLOCK RELAY, NORMALLY CLOSED
H2/G	BLACK/WHITE	INPUT TO ON-BOARD INTERIOR LIGHT ILLUMINATION RELAY #87

**VIOLET and VIOLET/BLACK wires are common at the fuse holder.*

H2/G BLACK/WHITE input to on-board interior light illumination relay #87

This wire determines what the output polarity of H1/9 will be. If the door pin circuit is negative, connect to chassis ground. If the door circuit is positive, connect to a fused 12V source.

IMPORTANT! *The H2/G wire is not required for wiring the door locks. Depending on the type of door lock system, there may be additional wires in the Door Lock Harness (H2) that are not required used in wiring the door locks.*

H2/A - H2/F power door lock wires

The system has door lock relays on-board, and can directly interface with most electric power door lock systems drawing 20 amps or less. These can also drive aftermarket actuators directly. (Some vehicles require that an aftermarket actuator be added to the driver's door to allow system control, see *Type D* wiring section).

identifying the door lock system

The easiest way to determine which type of door lock system you are working with is to remove the master locking switch itself, which is usually on the driver's door or on the center console. Once you have determined which type of factory door lock circuit you are working with, and the color codes of the switch wires to be used, you can usually simplify the installation by locating the same wires in the vehicle's kick panel. If no central locking switch is found, the installation may require a door lock actuator.

NOTE: *Always retest the wires in the kick panel to be sure they function the same way as the wires on the switch.*

There are eight common types of door lock circuits (some vehicles use more unusual systems):

- **Type A:** Three-wire (+) pulse controlling factory lock relays. Most GM, some Ford and Chrysler, 1995 Saturn, some new VW, newer BMW.
- **Type B:** Three-wire (-) pulse controlling factory lock relays. Most Asian vehicles, early Saturn, some BMW and Porsche.
- **Type C:** Direct-wired reversing-polarity switches. The switches are wired directly to the motors. This type of system has no factory relays. Most Fords, many GM two-doors cars and trucks, many Chryslers.
- **Type D:** Adding one or more aftermarket actuators. These include slave systems without an actuator in the driver's door, but with factory actuators in all the other doors. Type D also includes cars without power locks, which will have actuators added. All Saabs before 1994, many older Volvo except 850i, Subaru, Isuzu, Mazdas, and mid-eighties Nissans, pre-1985 Mercedes-Benz and Audi.
- **Type E:** Electrically-activated vacuum systems. The vehicle must have a vacuum actuator in each door. Make sure that locking the doors from the driver's or passenger side using the key activates all the actuators in the vehicle. This requires a slight modification to the door lock harness. Mercedes-Benz and Audi.
- **Type F:** One-wire system - cut to lock, ground to unlock. This system is found in some Nissan Sentras, some Nissan 240SX, and some Nissan 300ZX. It is also found in older Mitsubishi's, and some early Mazda MPV's.
- **Type G:** Positive (+) multiplex. This system is most commonly found in Ford, Mazda, Chrysler and GM vehicles. The door lock switch or door key cylinder may contain either one or two resistors.
- **Type H:** Negative (-) multiplex. The system is most commonly found in Ford, Mazda, Chrysler and GM vehicles. The door lock switch or door key cylinder may contain either one or two resistors.

at the switch

- Three-wire switches will have either a constant ground input or a constant (+)12V input, along with the pulsed lock and unlock outputs to the factory relays.
- Many BMW's and VW's have no external switch. The switches are inside the actuator, and instead of pulsing, the proper wires will flip-flop from (+)12V to (-) ground as the door locks are operated.
- Direct-wired switches will have a (+)12V constant input and one or two (-) ground inputs, along with two output leads going directly to the lock motors.

type B: negative-triggered, relay-driven system

This system is common in many Toyota, Nissan, Honda, and Saturn models, as well as Fords with the keyless-entry system (some other Fords also use Type B).

The switch will have three wires on it, and one wire will test ground all the time. One wire will pulse (-) when the switch locks the doors, and the other wire will pulse (-) when the switch unlocks the doors. This type of system is difficult to mistake for any other type.

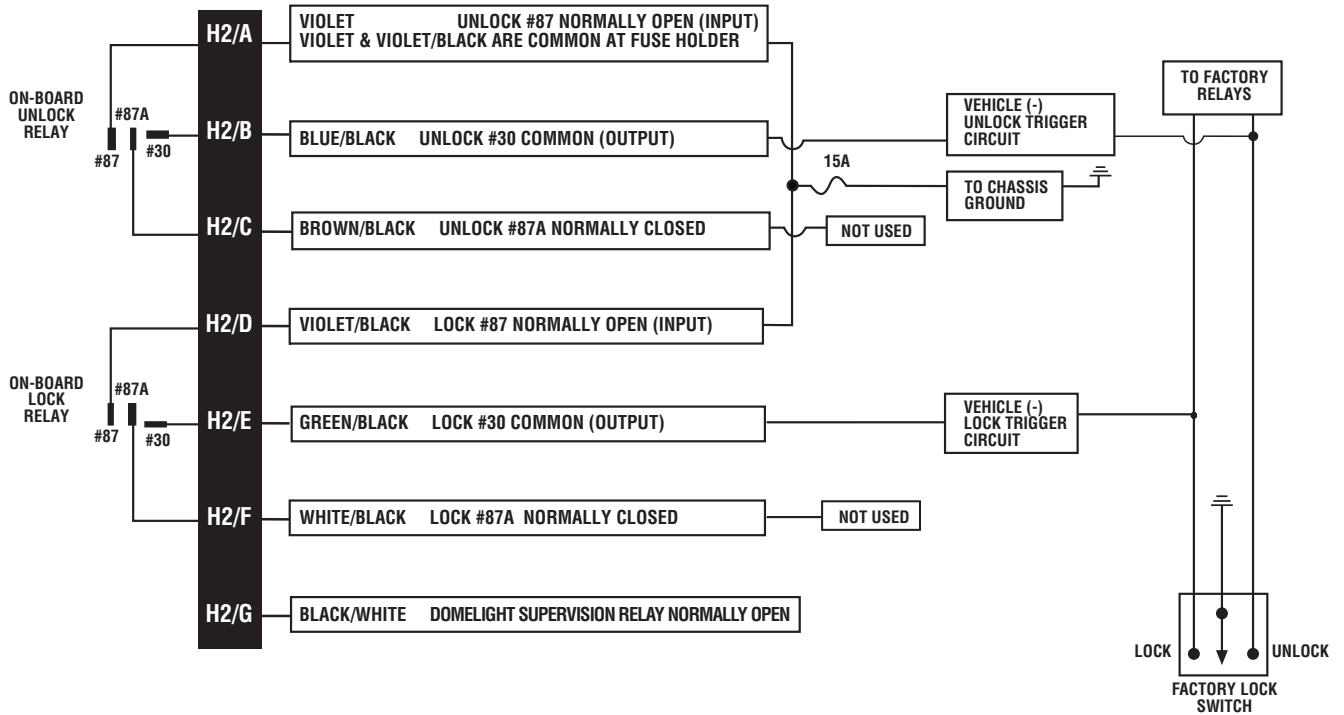

type D: adding one or more after-market actuators

Vehicles without factory power door locks require the installation of one actuator per door. This requires mounting the door lock actuator inside the door. Other vehicles may only require one actuator installed in the driver's door if all door locks are operated when the driver's lock is used.

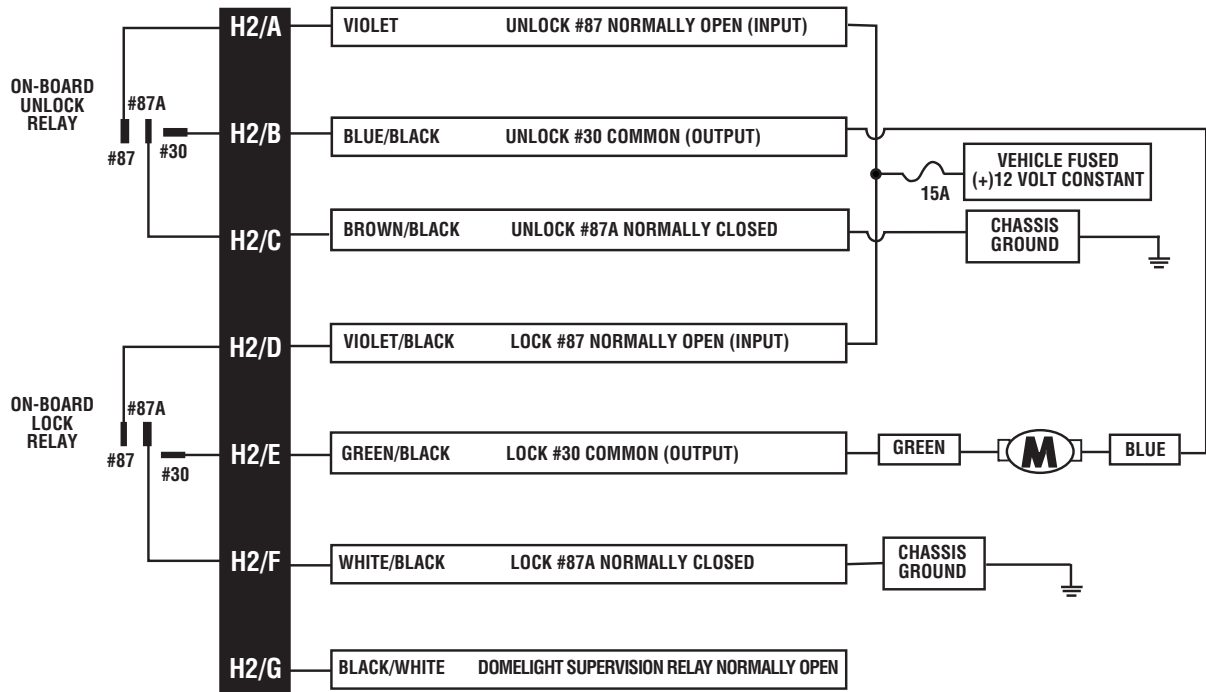

type E: electrically-activated vacuum

This system is found in some older Mercedes-Benz and Audi. The door locks are controlled by an electrically activated vacuum pump. The control wire will show (+)12V when doors are unlocked and (-) ground when locked.

NOTE: The system must be programmed for 3.5-second door lock pulses, and the violet jumper between the #87 lock terminal and the #87 unlock terminal must be cut.

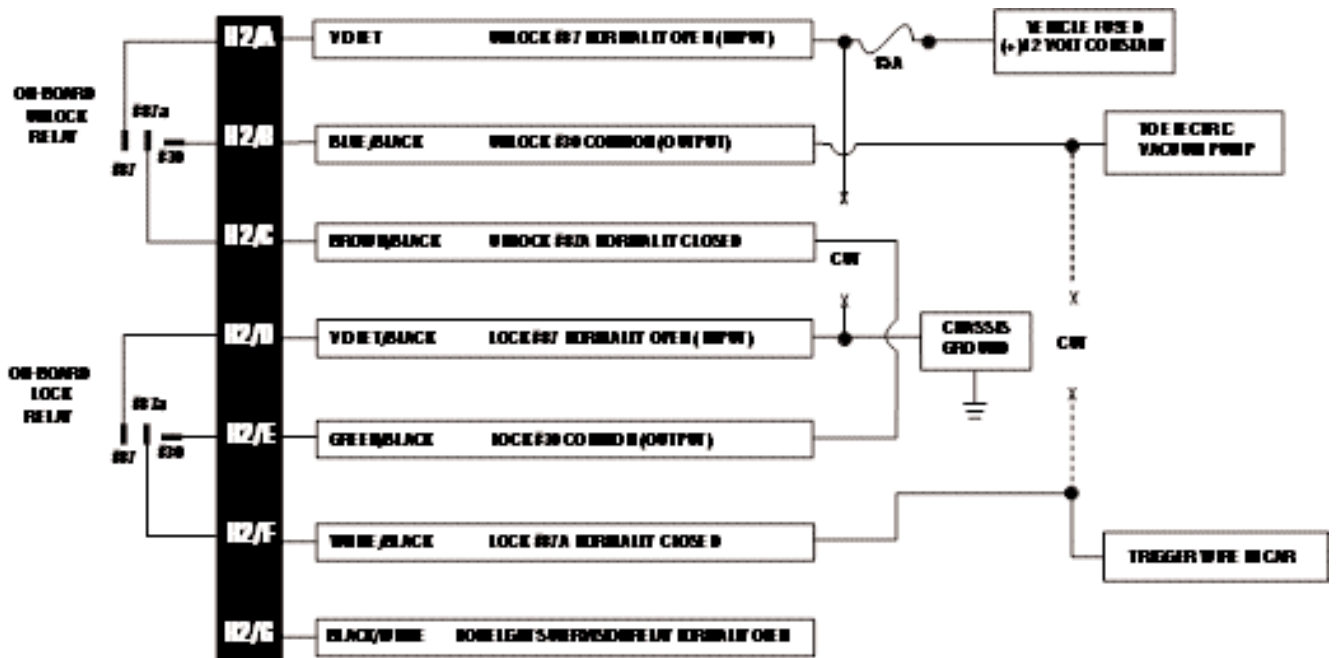

type F: one-wire system (cut to lock, ground to unlock)

This type of door lock system usually requires a negative pulse to unlock, and cutting the wire to lock the door. (With some vehicles, these are reversed.) It is found in some older Nissan Sentras, Nissan 240SX, and Nissan 300ZX. It is also found in some Mazda MPV's.

NOTE: The violet jumper between the #87 lock terminal and the #87 unlock terminal must be cut.

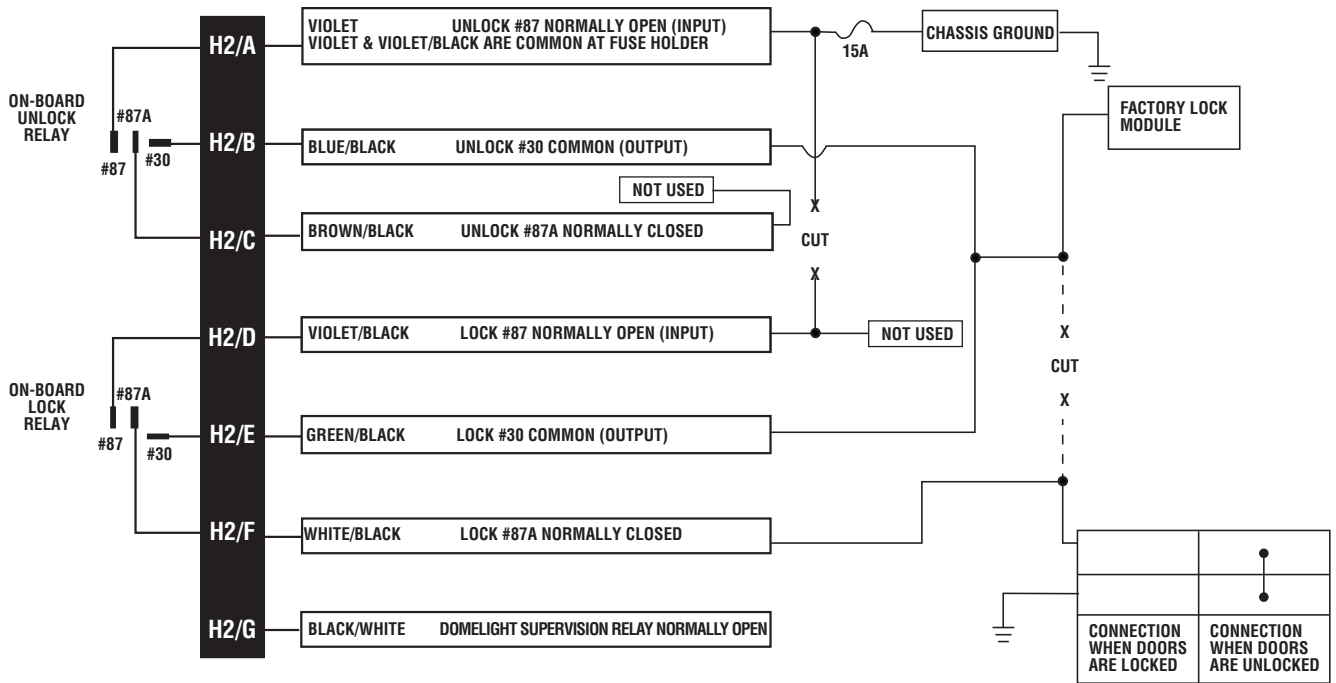

type G: positive (+) multiplex

This system is most commonly found in Ford, Mazda, Chrysler and GM vehicles. The door lock switch or door key cylinder may contain either one or two resistors.

SINGLE-RESISTOR TYPE: If one resistor is used in the door lock switch/key cylinder, the wire will pulse (+)12V in one direction and less than (+)12V when operated in the opposite direction.

TWO-RESISTOR TYPE: If two resistors are used in the factory door lock switch/key cylinder, the switch/key cylinder will read less than (+)12V in both directions.

DETERMINING THE PROPER RESISTOR VALUES: To determine the resistor values, the door lock switch/key cylinder must be isolated from the factory door lock system. For testing, use a calibrated digital multimeter that is set to ohms.

IMPORTANT: To ensure an accurate resistance reading, do not touch the resistor or leads during testing.

1. Cut the output wire from the door lock switch/key cylinder in half.
2. Test with the meter from the switch side of the cut door lock switch/key cylinder wire to a reliable constant (+)12V source. Some good constant (+)12V references are the power input source to the door lock switch/key cylinder, the ignition switch power wire, or the (+) terminal of the battery.
3. Operate the door lock switch/key cylinder in both directions to determine the resistor values. If the multi-meter displays zero resistance in one direction, no resistor is needed for that direction.
4. Once the resistor value(s) is determined, refer to the wiring diagram for proper wiring.

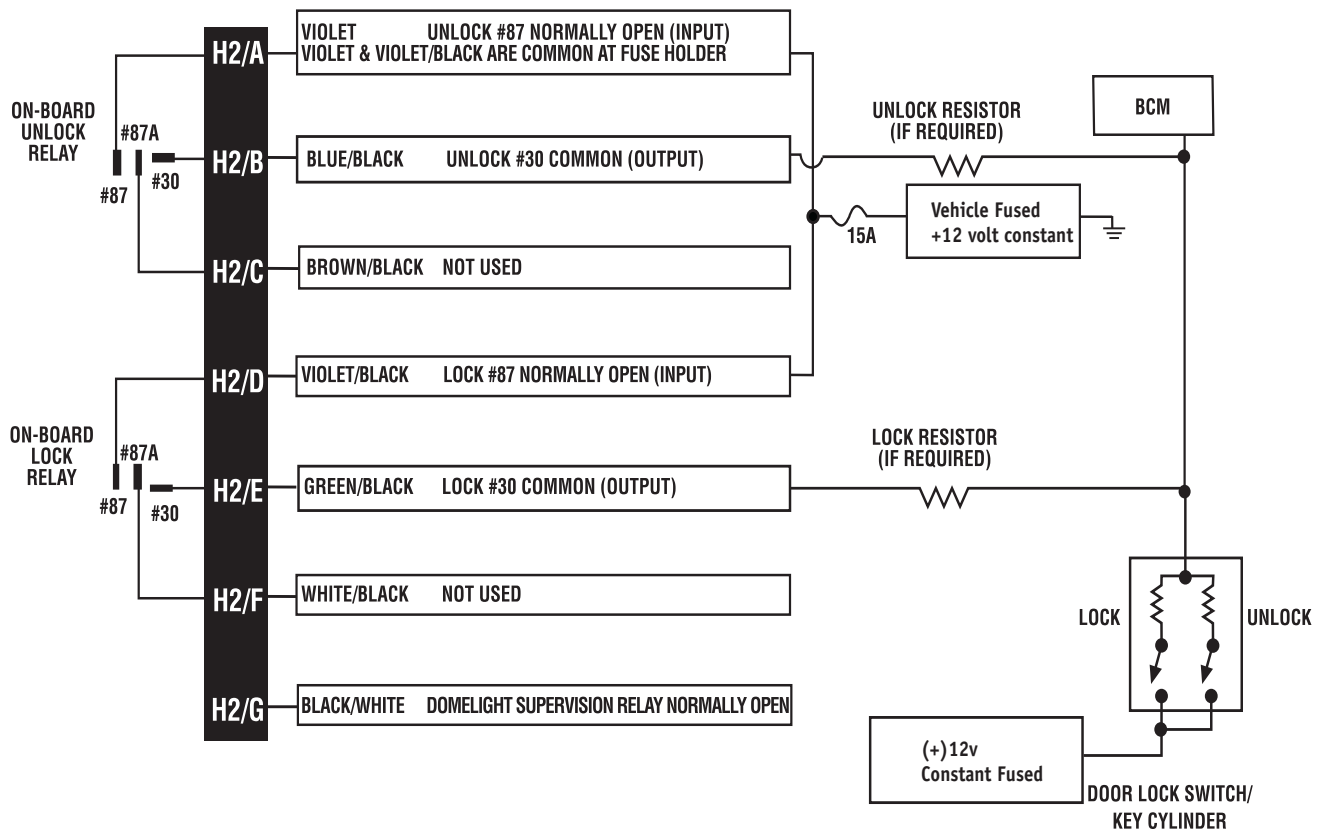

type H: negative (-) multiplex

The system is most commonly found in Ford, Mazda, Chrysler and GM vehicles. The door lock switch or door key cylinder may contain either one or two resistors.

SINGLE-RESISTOR TYPE: If one resistor is used in the door lock switch/key cylinder, the wire will pulse ground in one direction and resistance to ground when operated in the opposite direction.

TWO-RESISTOR TYPE: If two resistors are used in the factory door lock switch/key cylinder, the door lock switch/key cylinder will read resistance to ground in both directions.

DETERMINING THE PROPER RESISTOR VALUES: To determine the resistor values, the door lock switch/key cylinder must be isolated from the factory door lock system. For testing, use a calibrated digital multimeter that is set to ohms.

IMPORTANT: To ensure an accurate resistance reading, do not touch the resistor or leads during testing.

1. Cut the output wire from the door lock switch/key cylinder in half.
2. Test with the meter from the switch side of the cut door lock switch/key cylinder wire to a reliable ground source. Some good ground references are the ground input source to the door lock switch/key cylinder or the battery ground.
3. Operate the door lock switch/key cylinder in both directions to determine the resistor values. If the multi-meter displays zero resistance in one direction, no resistor is needed for that direction.
4. Once the resistor value(s) is determined, refer to the wiring diagram for proper wiring.

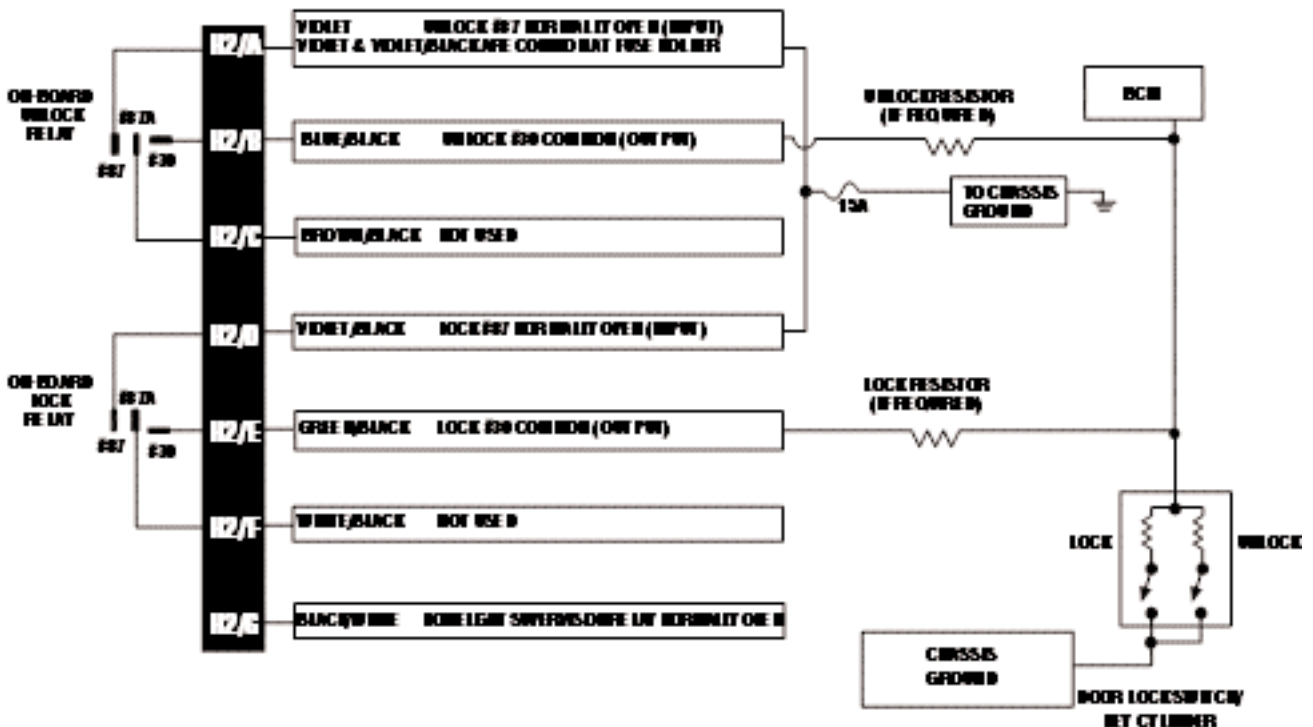

auxiliary harness (H3) wire connection guide

H3/1	VIOLET/BLACK	(-) 200 mA CHANNEL 4 OUTPUT
H3/2	BROWN/BLACK	(-) 200 mA HORN HONK OUTPUT
H3/3	BLUE	(-) 200 mA SECOND UNLOCK

H3/1 VIOLET BLACK (-) 200mA channel 4 output

This wire supplies a (-)200mA output whenever the button(s) controlling channel four is pressed and will continue until the button(s) is released. This output can be used to control optional accessories.

IMPORTANT! Never use this wire to drive anything but a relay or a low-current input! This transistorized output can only supply (-)200 mA, and connecting directly to a solenoid, motor, or other high-current device will cause the module to fail.

NOTE: Many of the options that can be operated with this output require the addition of the relay accessory package (p/n 8617).

H3/2 BROWN/BLACK (-) 200mA horn honk output

This wire supplies a (-) 200 mA output that can be used to honk the vehicle's horn. It provides a single pulse when armed and two pulses when disarmed. This wire also provides pulsed output when the security system is in the triggered sequence or in panic mode. In most vehicle's with (-) horn circuits this wire can control the vehicle's horn without adding a relay.

NOTE: If this output is used to drive a (+) horn circuit, an optional standard automotive SPDT relay or a relay assembly package (p/n 8617) must be used. See the following diagram.

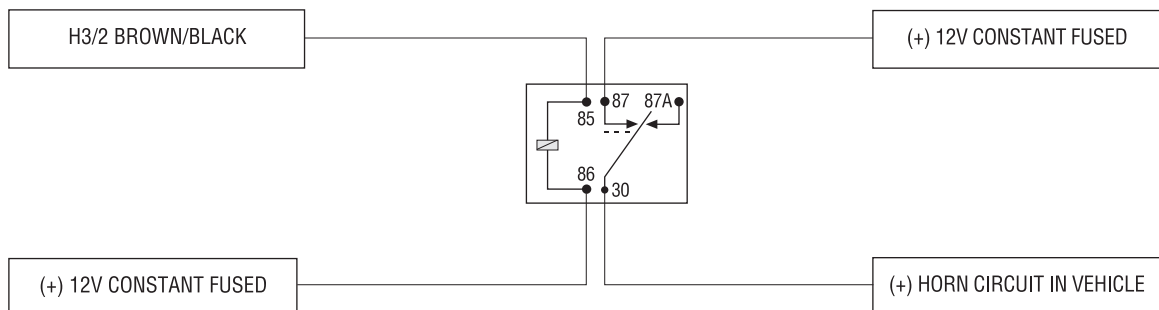

H3/3 BLUE (-) 200mA second unlock output

This output is used for progressive door unlock. A progressive unlock system unlocks the driver's door when the unlock (disarm) button is pressed and unlocks the passenger doors if the unlock (disarm) button is pressed again within 15 seconds after unlocking the driver's door. The BLUE wire outputs a low current (-) pulse on the second press of the unlock button of the transmitter. This negative unlock output is used to unlock the passenger doors.

NOTE: The second unlock output feature is not available if the double pulse unlock feature is turned on.

IMPORTANT! The H2/G wire is not required for wiring the door locks. Depending on the type of door lock system, there may be additional wires in the Door Lock Harness (H2) that are not required in wiring the door locks.

Driver's Door Unlock Only (Type A):

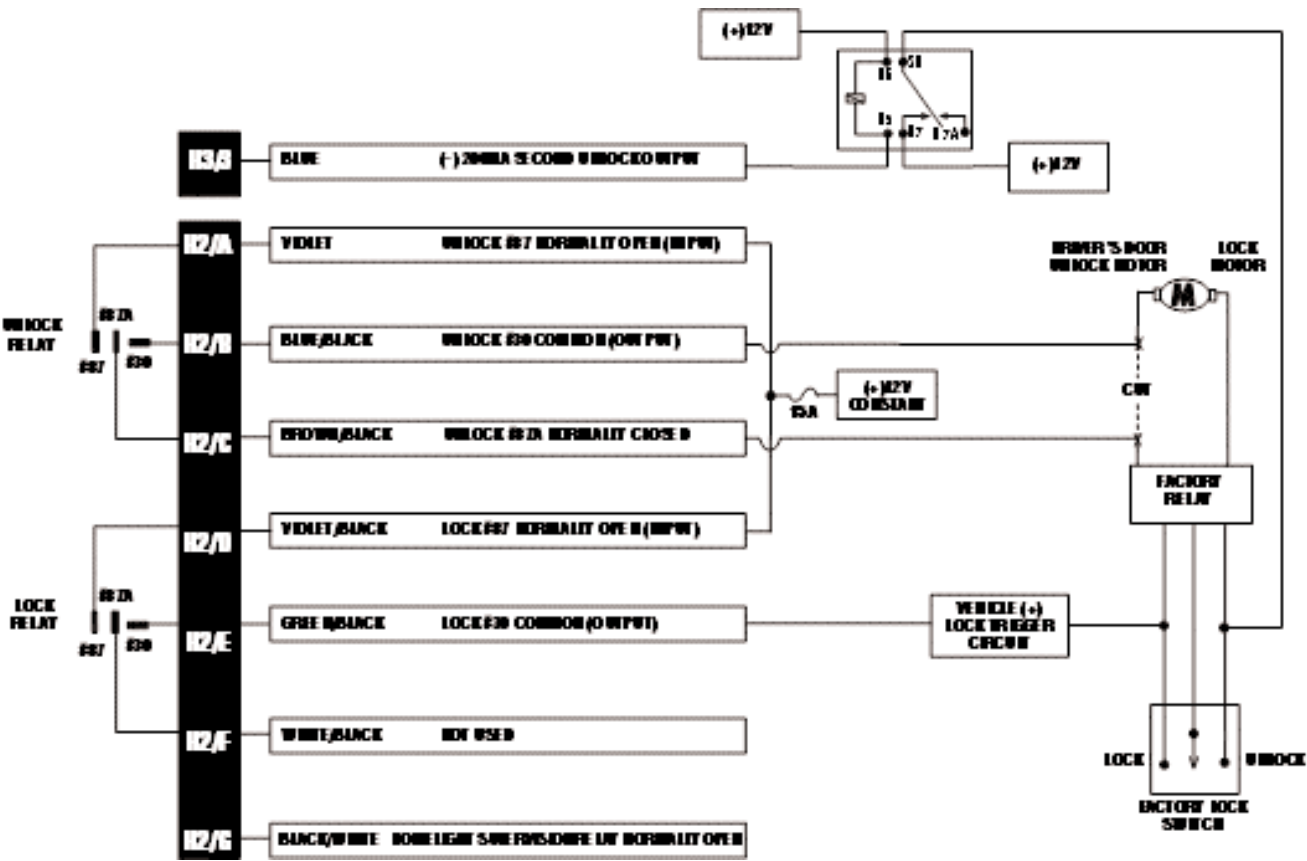

Driver's Door Unlock Only (Type B):

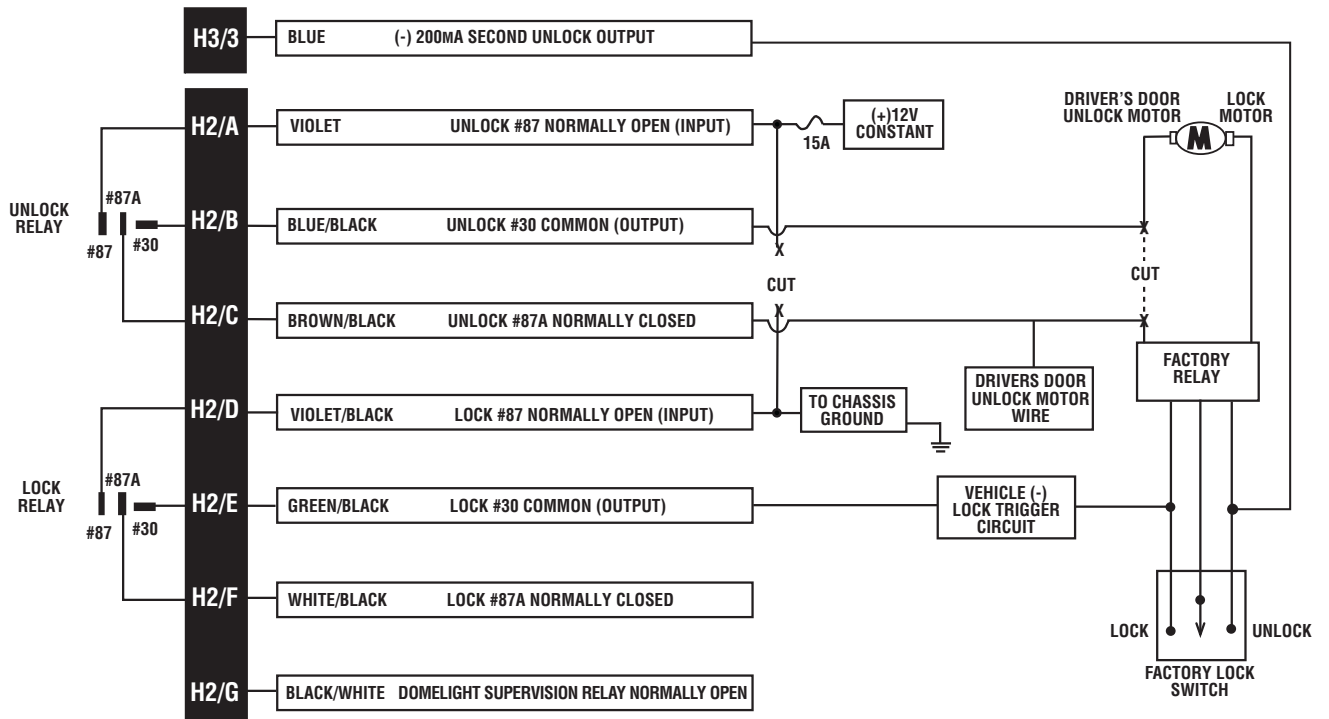

NOTE: The VIOLET jumper between the #87 lock terminal and the #87 unlock terminal must be cut and connected to the proper polarities.

starter interrupt harness (H4) wire connection guide

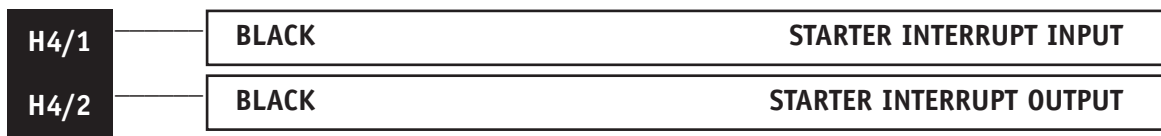

H4/1 and H4/2 BLACK starter interrupt wires

Use one of these wire as a starter interrupt input and the other as a starter interrupt output wire.

NOTE: These two black wires are interchangeable.

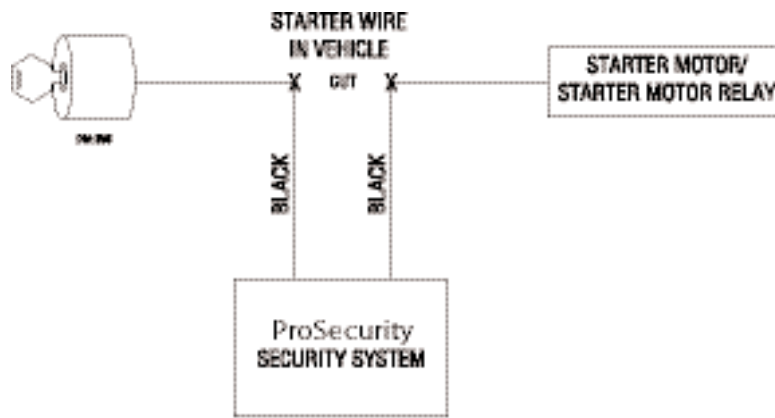

plug-in LED and valet/program switch

The LED and the Valet/Program switch both plug into the control module. The LED system status indicator plugs into the white two-pin port, while the Valet/Program switch should be plugged into the blue two-pin port. The LED and Valet/Program switch each fit into $\frac{9}{32}$ -inch holes.

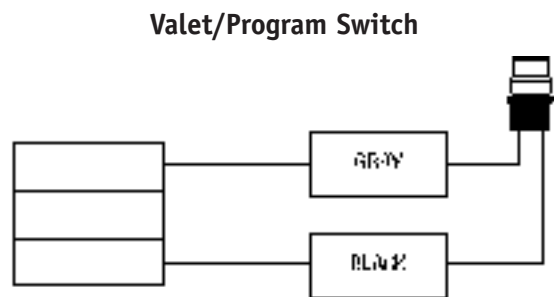
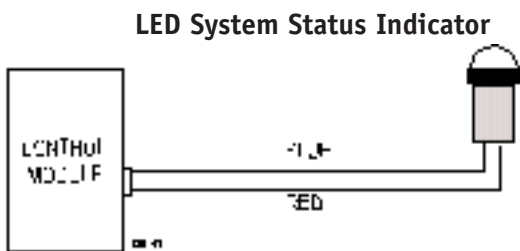

internal programming jumper

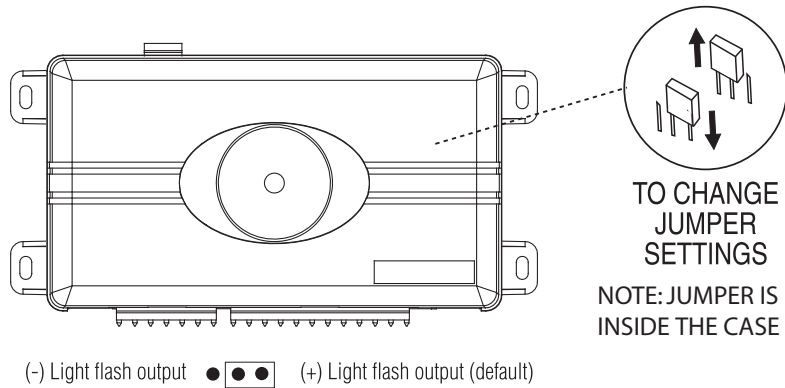

light flash jumper

This jumper is used to determine the light flash output. In the (+) position, the on-board relay is enabled and the unit will output (+)12V on the H1/11 WHITE wire. In the (-) position, the on-board relay is disabled. The H1/11 WHITE wire will supply a (-) 200 mA output suitable for driving factory parking light relays. To access the jumper, open the control module.

NOTE: For parking light circuits that draw 10 amps or more, the internal jumper must be switched to a (-) light flash output. P/N **8617** or a standard automotive SPDT relay must be used on the H1/11 light flash output harness wire.

on-board dual stage impact sensor

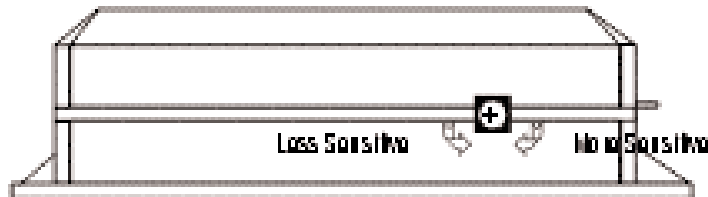

There is a dual-stage impact sensor inside the control unit. Adjustments are made via the rotary control as indicated above. Since the impact sensor does not work well when mounted firmly to metal, we recommend against screwing down the control module. We recommend mounting the control module to a large wiring loom.

NOTE: When adjusting the sensor, it must be mounted in the same location where it will be after the installation is completed. Adjusting the sensor and then relocating the module requires readjustment.

bypassing sensor inputs

There are times when you need to temporarily bypass all sensor inputs to the unit, such as when remote starting the vehicle. Anytime an auxiliary channel output is used, all inputs are bypassed for 5 seconds. During the 5 second bypass period, ground can be supplied to the H1/7 BLUE wire without triggering the unit. When the 5 second bypass period ends, if the unit detects ground on the H1/7 BLUE wire, all trigger inputs except the door trigger input will remain bypassed until 5 seconds after ground is removed from the BLUE wire. This can be done using the status output of the remote start unit as shown below:

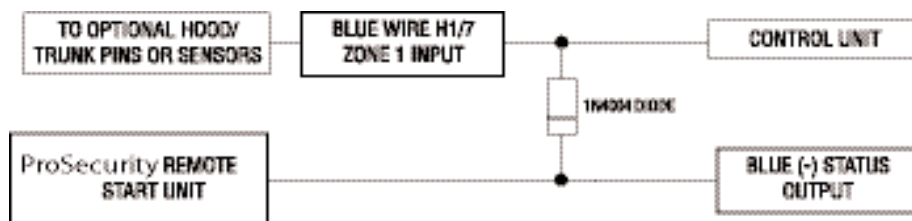

transmitter/receiver learn routine

The system comes with two transmitters that have been taught to the receiver. Use the following learn routine to add transmitters to the system or to change button assignments if desired.

The Valet/Program switch, plugged into the blue port, is used for programming. There is a basic sequence to remember whenever programming this unit: Door, Key, Choose, Transmit and Release.

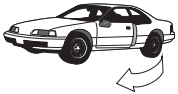

1. **Open a door.** (The GREEN wire, H1/8, or the VIOLET, H1/6 must be connected.)



2. **Key.** Turn the ignition on. (The H1/4 YELLOW switched ignition input must be connected.)



3. **Choose.** Press and release the Valet/Program switch the number of times necessary to access the desired channel, then press the switch once more and Hold it. The siren will chirp and the LED will blink the number of times corresponding to the channel that has been accessed.

CHANNEL NUMBER	PRESS AND RELEASE THE VALET/PROGRAM SWITCH	TO PROGRAM FUNCTION
1	One Time	Arm/Disarm/Panic
2	Two Times	Channel 2
3	Three Times	Channel 3
4	Four Times	Channel 4
5	Five Times	Arm Only
6	Six Times	Disarm Only
7	Seven Times	Panic Only
8	Eight Times	Auto-learn* (4-button and LCD 2-way transmitters)
9	Nine Times	Auto-Learn* (3-button optional transmitter)
10	Ten Times	Delete all Transmitters**

***NOTE:** See Transmitter Configuration section of this guide for a description of Auto-learn transmitter programming.

****NOTE:** If any button from a known transmitter is programmed to Channel 10, all transmitters will be erased from memory and the system will revert to the default feature settings. (See Features Menu section of this guide.)



4. **Transmit.** While **HOLDING** the Valet/Program switch, press the transmitter button that you wish to assign to that channel. The unit will chirp indicating successful programming.

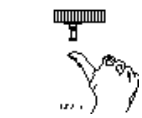

5. **Release.** Once the code is learned, the Valet/Program switch can be released.







You can advance from one channel to another by releasing the Valet/Program switch and tapping it to advance channels and then **HOLDING** it. For example, if you want to program Channel Three after programming Channel One, release the Valet/Program switch. Press it twice and release it to advance to Channel Three. Then press it once more and **HOLD** it. The siren will chirp three times to confirm it is ready to receive the code from the transmitter.

One long chirp will indicate that Code Learning has been exited if any of the following occurs:

- Ignition is turned off.
- The doors are closed.
- Valet/Program switch is pressed too many times.
- More than 15 seconds elapses between steps.













4-button transmitter configuration

The standard 4-button and LCD 2-way transmitters can be programmed in one step by using the Auto-learn function. When programmed for Standard Configuration, the 4-button transmitter buttons are assigned to the following functions:

-  Buttonoperates.....Arm
-  Buttonoperates.....Disarm
- AUX** Buttonoperates.....Channel Two
-  Buttonoperates.....Panic
-  and  Buttons.....operateChannel Three
- AUX** and  ButtonsoperateChannel Four

LCD 2-way transmitter additional controls

The LCD 2-way transmitter has the following additional controls:

 ,  and 	operates	No function
	operates	Remote extended functions/LCD backlight
 and 	operates	Battery Saver Mode
 and 	operate	Beep/Vibrate Notification
 and 	operate	Time/Alarm Display
 and 	operates	Parking Timer

system features learn routine

Many of the features of this unit are programmable. They can be changed whenever necessary through this learn routine. The Valet/Program switch, plugged into the blue port, is used together with a programmed transmitter to change the settings.

To enter the feature learn routine:



1. **Open a door.** (The GREEN wire, H1/8, or the VIOLET, H1/6 must be connected.)

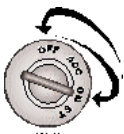

2. **Ignition.** Turn the ignition on, then back off. (The H1/4 YELLOW switched ignition input must be connected.)

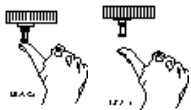

2. **Choose.** Within 10 seconds, press and release the Valet/Program switch the number of times corresponding to the feature number you want to program (see the *Features Menu* section of this guide). Then press the switch once more and hold it.

The LED will flash and the siren will chirp to indicate which feature you have accessed.



4. **Transmit.** While **HOLDING** the Valet/Program switch, you can select the desired features setting using the remote transmitter. Pressing the lock icon transmitter button while **HOLDING** down the Valet/Program switch will program the feature to the LED ON (default) setting. The siren will chirp once. Pressing the unlock icon transmitter button while **HOLDING** down the Valet/Program switch will change the setting to the LED OFF setting. The siren will chirp twice.

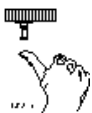

5. **Release.** Release the Valet/Program switch.

To access another feature:

You can advance from feature to feature by pressing and releasing the Valet/Program switch the number of times necessary to get from the feature you just programmed to the feature you wish to access. For example, if you just programmed Feature 1 and you want to program Feature 2:

1. Release the Valet/Program switch.
2. Press and release the Valet/Program switch once to advance from Feature 1 to Feature 2.
3. Press the Valet/Program switch once more and **HOLD** it.
4. The siren will chirp two times to confirm that you have accessed Feature 2.

To exit the Code Learning, do one of the following:

- The doors are closed.
- Turn the ignition on.
- No activity for longer than 15 seconds.
- Press the Valet/Program switch too many times.

features menu

FEATURE NUMBER	DEFAULT LED ON SETTINGS (PRESS LOCK ICON TRANSMITTER BUTTON)	LED OFF SETTINGS (PRESS UNLOCK ICON TRANSMITTER BUTTON)
1	Active Arming	Passive Arming
2	Confirmation Chirps ON	Confirmation Chirps OFF
3	Ignition Controlled Door Lock/Unlock ON	Ignition Controlled Door Lock/Unlock OFF
4	Active Locking	Passive Locking
5	0.8-second Door Lock Pulse Duration	3.5-second Door Lock Pulse Duration
6	Double Pulse Unlock OFF	Double Pulse Unlock ON
7	Code Hopping ON	Code Hopping OFF
8	Door trigger error chirp ON	Door trigger error chirp OFF
9	Lock pulse Single	Lock pulse Double
10	Comfort closure OFF	Comfort closure ON (20-seconds)

***NOTE:** Factory defaults are indicated in **bold** type.*

feature descriptions

1 ACTIVE/PASSIVE ARMING: When active arming is selected, the system will only arm when the transmitter is used. When set to passive, the system will arm automatically 30 seconds after the last protected entry is closed. Passive arming is indicated by the rapid flashing of the LED when the last protected entry point is closed.

2 CONFIRMATION CHIRPS ON/OFF: This feature controls the chirps that confirm the arming and disarming of the system.

3 IGNITION-CONTROLLED DOOR LOCK/UNLOCK ON/OFF: When turned on, the doors will lock three seconds after the ignition is turned on and unlock when the ignition is turned off. If the ignition key is turned on while the vehicle door(s) are open, the door(s) will not lock.

4 ACTIVE/PASSIVE LOCKING: If passive arming is selected in Feature 1, then the system can be programmed to either lock the doors when passive arming occurs, or only lock the doors when the system is armed with the transmitter. Active locking means the system will not lock the doors when it passively arms. Passive locking means that the system will lock the doors when it passively arms.

5 DOOR LOCK PULSE DURATION: Some European vehicles, such as Mercedes-Benz and Audi, require longer lock and unlock pulses to operate the vacuum pump. Programming the system to provide 3.5 second pulses will accommodate door lock interface in these vehicles. The default setting is 0.8 second door lock pulses. See *Mercedes-Benz and Audi - 1985 and Newer (Type E Door Locks section)* diagram.

6 DOUBLE PULSE UNLOCK OFF/ON: Some vehicles require two pulses on a single wire to unlock the doors. When the double pulse unlock feature is turned on, the H2/B BLUE/BLACK wire will supply two pulses instead of a single pulse. This makes it possible to directly interface with double pulse vehicles without any extra parts.

***NOTE:** The second unlock output feature (H3/3 BLUE wire) is not available if the double pulse unlock feature is turned on.*

7 CODE HOPPING TECHNOLOGY ON/OFF: This system features Code Hopping Technology as an option. Code Hopping Technology is a feature that uses a mathematical formula to change the system's code each time the transmitter and receiver communicate. This makes the group of bits or "word" from the transmitter very long. The longer the word is, the easier it is to block its transmission to the unit. Disabling the Code Hopping Technology feature lets the receiver ignore the Code Hopping Technology part of the transmitted word. As a result, the unit may have better range with Code Hopping Technology off.

8 DOOR SENSOR BYPASS CHIRP ON/OFF: This feature controls the error chirp that is generated if the system is armed with the door trigger active. This is useful in vehicles that have a long dome light delay after the door has been closed. If the system is armed before the dome light has turned off, the security system will generate the door trigger error chirp. If this error chirp is not desired, use this feature to disable the door open error chirp. If the bypass chirp is turned off, no bypass chirp will be generated, even if a door is accidentally left open.

9 Double Pulse Lock. Selectable 2 pulse door lock output to operate vehicle equipped with factory "deadbolt". Will have similar operation to that of the Double Pulse Unlock feature, but will perform the functions on the Lock wire as opposed to the Unlock wire

10 Comfort closure feature: This feature is designed to integrate with vehicles that can close the power windows and sunroof by holding the key in the driver door lock position, and will operate on both single input systems and two pulses input dead bolt systems.

If programmed on the door lock output will activate the Comfort Close output for 20 seconds. This output will begin 200mS after the final door lock output has completed regardless of the door lock programming.

If while the 20 second timer is active and closing the windows the user disarms the unit, the Comfort Close output will immediately cease before the doors unlock.

The alarm system will not monitor the zone inputs for Bypass Notification, Warn away or Full trigger inputs until after the 20 second timer has completed to avoid any false triggering of the system while the window are in motion.

nuisance prevention[®] circuitry[™]

NPC[®] requires that you change the way you test the system, as NPC[®] will bypass an input zone for 60 minutes. If the system “sees” the same zone trigger three times AND the triggers are spaced less than an hour apart, the system will bypass that input zone for 60 minutes. If that zone does not attempt to trigger the system during the 60-minute bypass period, the zone’s monitoring will begin again at the end of the hour. If it does attempt to trigger while bypassed, the 60-minute bypass starts over again.

Disarming and rearming the system does not reset NPC[®]. The only way to reset NPC[®] is for the 60 minutes to pass, without a trigger, or for the ignition to be turned on. This allows the system to be repeatedly triggered, disarmed and rearmed, and still allow NPC[®] to bypass a faulty zone.

When disarming the system, 5 chirps indicate NPC[®] is activated. The LED will report the zone that has been bypassed. (See *Table of Zones* section of this guide.)

table of zones

When using the Diagnostic functions, use the Table of Zones to see which input has triggered the system. It is also helpful in deciding which input to use when connecting optional sensors and switches.

ZONE NO.	TRIGGER TYPE	INPUT DESCRIPTION
1	Multiplex	H1/7 BLUE wire. Connects to optional hood/trunk pins or an optional sensor. Inputs longer than 0.8 seconds will instantly trigger the full alarm sequence and report Zone 1.
2	On-board impact sensor	Second-stage of on-board impact sensor (heavy impacts from impact sensor).
3	Two-stage, progresses from warning to full alarm	Door switch circuit. H1/8 GREEN or H1/6 VIOLET.
5	Two-stage, progresses from warning to full alarm	Ignition. H1/4 YELLOW.

NOTE: *The Warn-away response does not report on the LED.*

troubleshooting

■ **Door input does not immediately trigger full alarm. Instead, first I hear chirps for 3 seconds:**

That's how the progressive two-stage door input works! This is a feature of this system. This is an instant trigger, remember, since even if the door is instantly re-closed, the progression from chirps to constant siren will continue.

■ **Closing the door triggers the system, but opening the door does not:**

Have you correctly identified the type of door switch system? This often happens when the wrong door input has been used. (See *H1/8 GREEN Door Trigger Input, Primary Harness Wire Connection Guide* section of this guide.)

■ **System will not passively arm until it is remotely armed and then disarmed:**

Are the door inputs connected? Is the H1/7 blue wire connected to the door trigger wire in the vehicle? Either the H1/8 green or the H1/6 violet should be used instead. (See *Primary Harness Wire Connection Guide* section of this guide.)

■ **Door input does not respond with the progressive trigger, but with immediate full alarm:**

Does the LED indicate that the trigger was caused by the impact sensor? (See *Table of Zones* section of this guide.) The impact sensor, if set to extreme sensitivity, may be detecting the door unlatching before the door switch sends its signal. Reducing the sensitivity can solve this problem.

■ **The Valet/Program switch does not work:**

Is it plugged into the correct socket? (See *Plug-In LED and Valet/Program Switch* section of this guide.)

■ **The LED system status indicator does not work:**

You've probably guessed already, but here goes: is it plugged in? Is the LED plugged into the correct socket? (See *Plug-In LED and Valet/Program Switch* section of this guide.)

■ **Starter interrupt does not work:**

Is the correct wire being interrupted? If the vehicle starts when the starter interrupt is completely disconnected, the wrong wire has been cut.

Is the yellow H1/4 ignition wire connected to true ignition? This wire must be powered in the run and start positions of the ignition switch in order to work properly.

